



2225848110

Order no. P222 0200 13 Part no. 222 584 81 10  
Edition A 2019

# S-Class

Plug-in hybrid Supplement

Mercedes-Benz





## Symbols

In this Operator's Manual, you will find the following symbols:

 **DANGER** Danger due to not observing the warning notices

Warning notices draw your attention to hazards that may endanger your health or life, or the health or life of others.

 Please observe the warning notices in this manual.

 **ENVIRONMENTAL NOTE** Environmental damage due to failure to observe environmental notes

Environmental notes include information on environmentally responsible behavior or environmentally responsible disposal.

 Observe environmental notes.

 **NOTE** Damage to property due to failure to observe notes on material damage

Notes on material damage inform you of risks which may lead to your vehicle being damaged.

 Observe notes on material damage.

 Useful instructions or further information that could be helpful to you.

 Instruction

( → page) Further information on a topic

**Display** Information in the multifunction display/multimedia display

 Highest menu level, which is to be selected in the multimedia system

 Corresponding submenus, which are to be selected in the multimedia system

\* Marks a cause

## Publication details

### Internet

Further information about Mercedes-Benz vehicles and about Daimler AG can be found on the following websites:

<http://www.mbusa.com> (USA only)

<http://www.mercedes-benz.ca> (Canada only)

### Editorial office

©Daimler AG: Not to be reprinted, translated or otherwise reproduced, in whole or in part, without written permission from Daimler AG.

### Vehicle manufacturer

Daimler AG

Mercedesstrasse 137

70327 Stuttgart

Germany

## Welcome to the world of Mercedes-Benz

Before you first drive off, read this Operator's Manual carefully and familiarize yourself with your vehicle. For your own safety and a longer vehicle life, follow the instructions and warning notices in this Operator's Manual. Disregarding them may lead to damage to the vehicle or personal injury.

Vehicle damage resulting from the disregard of the instructions is not covered by the Mercedes-Benz Limited Warranty.

The equipment or model designation of your vehicle may vary according to:

- Model
- Order
- National version
- Availability

Mercedes-Benz reserves the right to introduce changes in the following areas:

- Design
- Equipment
- Technical features

The equipment in your vehicle may therefore differ from that shown in the descriptions and illustrations.

The following are integral parts of the vehicle:

- Digital Operator's Manual
- Printed Operator's Manual
- Maintenance Booklet
- Equipment-dependent supplements

Keep these documents in the vehicle at all times. If you sell the vehicle, always pass all of the documents on to the new owner.

Mercedes-Benz USA, LLC

Mercedes-Benz Canada, Inc.

A Daimler Company

2225848110



---

<b>General notes</b> .....	4	<b>Operating modes</b> .....	15	<b>Charging the high-voltage battery</b> .....	25
Operator's Manual .....	4	Functions of the operating modes .....	15	Notes on high-voltage battery .....	25
Protecting the environment .....	4	Switching operating mode .....	17	Checking the charge level of the high-voltage battery .....	25
Operating safety .....	4			Function of the indicator lamp on the vehicle socket .....	25
Qualified specialist workshop .....	5	<b>Multimedia system</b> .....	18	Notes on charging the high-voltage battery at the mains socket (mode 2) .....	26
Correct use of the vehicle .....	5	Configuring settings for plug-in hybrid vehicles .....	18	Overview of the charging cable control panel, version 1 .....	27
Limited Warranty .....	5	Functions of the energy flow display .....	19	Setting the maximum permissible charging current for charging at a mains socket .....	29
Notes on plug-in hybrid operation .....	6	Showing the energy flow display .....	19	Notes on charging the high-voltage battery at a wallbox (mode 3) .....	30
Switching off the hybrid system manually .....	7			Notes on charging the high-voltage battery at a charging station (mode 3) .....	30
				Starting the charging process .....	31
				Ending the charging process .....	33
<b>Occupant safety</b> .....	9	<b>Displays and operation</b> .....	20		
Restraint system .....	9	Notes on the Instrument Display and on-board computer .....	20	<b>Driving and parking</b> .....	34
		DYNAMIC SELECT switch .....	20	Driving .....	34
<b>Climate control</b> .....	10	Haptic accelerator pedal function .....	22	Refueling .....	35
Overview of the control panel for automatic climate control .....	10	Function of the power display of the electric motor .....	23		
Pre-entry climate control via SmartKey .....	11	Function of the power meter .....	23		
Pre-entry climate control at time of departure .....	12	Displaying the power meter .....	23		
Activating/deactivating immediate pre-entry climate control .....	13	Function of the route-based operating-mode strategy .....	23		
		Activating route-based operating-mode strategy (ROS) .....	24		

---

---

<b>Breakdown assistance</b> .....	<b>37</b>
TIREFIT kit storage location .....	37
Starting assistance .....	37
Permitted towing methods .....	37

---

<b>Technical data</b> .....	<b>39</b>
Vehicle identification plate, VIN and engine number overview .....	39
Operating fluids .....	40
Vehicle data .....	41

---

<b>Display messages and warning/indicator lamps</b> .....	<b>43</b>
Display messages .....	43
Warning and indicator lamps .....	51

---

<b>Index</b> .....	<b>53</b>
--------------------	-----------

### Operator's Manual

This Supplement provides information on all the important functions of your hybrid vehicle that are either not described or differ from the descriptions in the vehicle Operator's Manual. This information supplements or replaces the corresponding sections in the vehicle Operator's Manual. Under no circumstances does the Supplement replace the Operator's Manual.

This Supplement describes all models, and standard and optional equipment for your vehicle, as available at the time of going to press. Country-specific differences are possible. Bear in mind that your vehicle may not feature all functions described here. This is also the case for systems and functions relevant to safety. Therefore, the equipment on your vehicle may differ from that in the descriptions and illustrations.

The original purchase contract documentation for your vehicle contains a list of all of the systems in your vehicle.

Should you have any questions concerning equipment and operation, please consult an authorized Mercedes-Benz Center.

The Operator's Manual, the Supplement and the Maintenance Booklet are important documents and should be kept in the vehicle.

### Protecting the environment



**ENVIRONMENTAL NOTE** Environmental pollution caused by irresponsible disposal of the high-voltage battery

A high-voltage battery contains materials which are harmful to the environment.

- ▶ Dispose of defective high-voltage batteries at a qualified specialist workshop.

### Operating safety

Hybrid vehicles have a combustion engine and an electric motor. The energy supply for operat-

ing the vehicle electrically is provided by the high-voltage on-board electrical system.

**⚠ DANGER** Risk of fatal injury by touching damaged high-voltage components

The vehicle's high-voltage on-board electrical system is under high voltage. If you modify component parts in the vehicle's high-voltage on-board electrical system or touch damaged component parts, you may be electrocuted.

The component parts in the vehicle's high-voltage on-board electrical system may be damaged in an accident, although the damage is not visible.

- ▶ After an accident, do not touch any high-voltage components and never modify the vehicle's high-voltage on-board electrical system.
- ▶ After an accident, have the vehicle transported away.
- ▶ Have the high-voltage on-board electrical system checked at a qualified specialist workshop.

The components of the high-voltage on-board electrical system are marked with yellow warning stickers. The cables of the high-voltage on-board electrical system are orange.

Vehicles with an electric motor generate much less driving noise than vehicles with internal combustion engines. As a result, your vehicle may not be heard by other road users in certain situations. This can happen, for example, when you are parking and your vehicle is not seen by other road users. This requires you to adopt a particularly anticipatory driving style, as it is necessary to allow for the possibility that other road users may behave unpredictably.

### Qualified specialist workshop

Always have the following work carried out on your vehicle at a qualified specialist workshop:

- Work relevant to safety
- Service and maintenance work
- Repair work
- Modifications as well as installations and conversions

- Work on electronic components
- Work on the hybrid system

### Correct use of the vehicle

If you remove any warning stickers, you or others could fail to recognize certain dangers. Leave warning stickers in position.

When using the vehicle, observe the following information:

- the safety notes in this manual
- technical data for the vehicle
- traffic rules and regulations
- laws and safety standards pertaining to motor vehicles

### Limited Warranty

**!** **NOTE** Damage to the vehicle arising from violation of these operating instructions.

Damage to the vehicle can arise from violation of these operating instructions.

This damage is not covered either by the Mercedes-Benz implied warranty or by the New- or Used-Vehicle Warranty.

▶ Follow the instructions in these operating instructions on proper operation of your vehicle as well as on possible vehicle damage.

### Notes on plug-in hybrid operation

**⚠ WARNING** Risk of chemical burns and poisoning from damaged high-voltage battery

If the housing of the high-voltage battery has been damaged, electrolyte and gases may leak out.

- ▶ Avoid contact with the skin, eyes or clothing.
- ▶ Immediately rinse electrolyte splashes off with water and seek medical attention straight away.

**⚠ DANGER** Risk of explosion from excessive internal pressure of the high-voltage battery

In the event of a vehicle fire, the internal pressure of the high-voltage battery could exceed a critical value. In this case, flammable gas escapes through a bleed valve in the vehicle's underbody.

The gas can ignite.

- ▶ Leave the danger zone immediately.
- ▶ Secure the danger zone at a suitable distance, whilst observing legal requirements.

The hybrid system combines a combustion engine with an electric motor.

Characteristics when the vehicle is at a standstill:

- the combustion engine is generally switched off.
- engine idling only occurs in certain instances.

Characteristics when starting the vehicle:

- if the high-voltage battery is sufficiently charged, the vehicle can be started with the electric drive without the combustion engine (noiseless start).
- if the high-voltage battery is not sufficiently charged or the operating temperature of the combustion engine has not been reached, the vehicle can start with the combustion engine.

Characteristics with moderate power output requirements:

- the combustion engine is switched off as often as possible during the journey.
- the vehicle can be accelerated electrically up to speeds of approximately 87 mph (140 km/h).

Characteristics with high power output requirements:

- the electric motor supports the combustion engine (boost effect), e.g. when pulling away or accelerating.
- the high-voltage battery is discharging.

Characteristics when releasing the accelerator pedal during the journey:

- the electric motor is operated as a alternator when in overrun mode and during braking.
- the high-voltage battery is charging.

Notes on electric driving:

- vehicles with hybrid systems generate significantly less noise than vehicles with combustion engines.



- when driving in electric mode the vehicle may not be heard by other road users due to the significantly less noise generated.
- depending on the vehicle's equipment and national legislation, the vehicle may be equipped with Acoustic Vehicle Indication.

#### Information on Acoustic Vehicle Indication:

- Acoustic Vehicle Indication generates a certain sound at a speed between 0 and 19 mph (30 km/h).
- this helps other road users, particularly pedestrians and bike riders, to hear your vehicle better.
- above this speed, natural vehicle noise is sufficient for the vehicle to be heard in good time by other road users.
- the sound can also be heard in the vehicle interior.
- the volume depends on the engine speed, the speed and the accelerator pedal position.
- Acoustic Vehicle Indication switches off at a speed of over 19 mph (30 km/h) because the natural vehicle noise is sufficient.

### Switching off the hybrid system manually

**⚠ DANGER** Risk of fatal injury by touching damaged high-voltage components

The vehicle's high-voltage on-board electrical system is under high voltage. If you modify component parts in the vehicle's high-voltage on-board electrical system or touch damaged component parts, you may be electrocuted.

The component parts in the vehicle's high-voltage on-board electrical system may be damaged in an accident, although the damage is not visible.

- ▶ After an accident, do not touch any high-voltage components and never modify the vehicle's high-voltage on-board electrical system.
- ▶ After an accident, have the vehicle transported away.
- ▶ Have the high-voltage on-board electrical system checked at a qualified specialist workshop.

Only deactivate the hybrid system manually in the following situations:

- The  restraint system warning lamp lights up in the instrument cluster, e.g. after an accident.
- The vehicle is badly damaged, e.g. after an accident, and the restraint system components were not activated.

## Using the high-voltage disconnect device

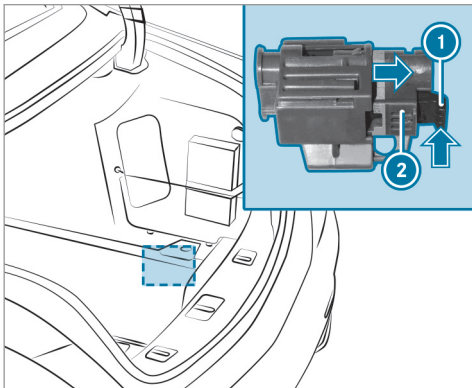

- ▶ Switch the ignition off.
- ▶ Switch the transmission to position **P**.
- ▶ Apply the electric parking brake.
- ▶ Secure the vehicle against rolling away (see the vehicle Operator's Manual).
- ▶ Open the trunk lid.



- ▶ Lift the trunk floor upwards.
- ▶ Remove the right-hand trim in the trunk.
- ▶ Press release clip ① in the direction of the arrow and pull it out.
- ▶ Pull high-voltage disconnect device ② in the direction of the arrow until it engages. The hybrid system is disconnected.

All work on the hybrid system (including after switching off manually) may only be carried out by a qualified specialist workshop.

## Restraint system

### Malfunctioning restraint system

A malfunction has occurred in the restraint system if:

- The  restraint system warning lamp does not light up when the ignition is switched on.
- The  restraint system warning lamp lights up continuously or repeatedly during a journey.

If the restraint system is malfunctioning, in the event of an accident the high-voltage on-board electrical system may not be deactivated as intended.

**⚠ DANGER** Risk of fatal injuries due to the restraint system malfunctioning

If the restraint system is malfunctioning, restraint system components may be triggered unintentionally or may not deploy as intended during an accident. This may affect the Emergency Tensioning Device or airbag,

for example. Furthermore, in the event of an accident, the high-voltage on-board electrical system may not be deactivated as intended.

You may be electrocuted if you touch the damaged component parts of the high-voltage on-board electrical system.

- ▶ Have the restraint system checked and repaired immediately at a qualified specialist workshop.
- ▶ After an accident, switch off the ignition immediately.

## Overview of the control panel for automatic climate control

The indicator lamps in the buttons indicate that the corresponding function is activated.

### Front control panel

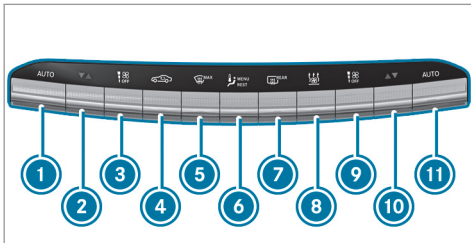

- ① **AUTO** Sets climate control to automatic, left
- ② **▼▲** Sets the temperature, left
- ③ **∞ OFF** Sets the airflow, left, or switches off climate control
- ④ **🚗** Switches air-recirculation mode on or off manually
- ⑤ **MAX** Defrosts the windshield

- ⑥ **MENU REST** Calls up the air conditioning menu of the multimedia system  
Switches the residual heat on or off
- ⑦ **REAR** Switches the rear window defroster on or off
- ⑧ **👤** Activates or deactivates "Immediate pre-entry climate control" (→ page 13)
- ⑨ **∞ OFF** Sets the airflow, right, or switches off climate control
- ⑩ **▼▲** Sets the temperature, right
- ⑪ **AUTO** Sets climate control to automatic, right

### Rear passenger compartment control panel

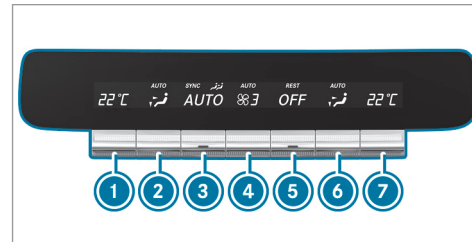

- ① Sets the temperature, left
- ② Sets the air distribution, left
- ③ Sets climate control to automatic mode
- ④ Sets the airflow
- ⑤ Switches the climate control on/off  
Switches the residual heat on or off
- ⑥ Sets the air distribution, right
- ⑦ Sets the temperature, right

## Pre-entry climate control via SmartKey

### Function of pre-entry climate control using the SmartKey

Before entering the vehicle, the driver's seat area or the whole vehicle interior can be briefly pre-warmed or pre-cooled.

When pre-cooling, the following functions are activated as needed:

- Automatic climate control
- Blower

When pre-heating, the following functions are activated as needed:

- Automatic climate control
- Blower
- Seat heating
- Mirror heater
- Rear window defroster

### Setting pre-entry climate control via SmartKey

Multimedia system:

➔ Vehicle ➔  Climate Control ➔ Pre-entry Climate Ctrl.

#### Activating or deactivating

▶ Activate  or deactivate  Via Key.

#### Selecting the zone

- ▶ Select **Select Zone**.
- ▶ Select **Entire Vehicle** or **Driver's Seat Only**.

### Switching pre-entry climate on/off control using the SmartKey

#### Requirements:

- The high-voltage battery is charged sufficiently.
- The function has been activated via the multimedia system.

- ▶ **To switch on:** unlock the vehicle. The climate control functions are activated for up to five minutes for pre-heating and pre-cooling.

Pre-entry climate control using the SmartKey cannot be activated more than twice when the vehicle is switched off.

- ▶ **To switch off:** press the  button up or down.

The following functions remain active after the vehicle has been started:

- Seat heating

## Pre-entry climate control at time of departure

### Pre-entry climate control at departure time function

**⚠ WARNING** Risk of fatal injury due to exposure to extreme heat or cold in the vehicle

If people – particularly children – are exposed to extreme temperatures over an extended period of time, there is a risk of serious or even fatal injury.

- ▶ Never leave anyone – particularly children – unattended in the vehicle.
- ▶ Never leave animals in the vehicle unattended.

The vehicle interior can be heated or ventilated when the vehicle is parked.

When the vehicle is connected to power supply equipment, priority is given to charging the high-voltage battery to a specified minimum charge.

The pre-entry climate control running time may be reduced under the following conditions:

- The vehicle is not connected to power supply equipment
- The high-voltage battery is not fully charged

With active pre-entry climate control, the charge level of the high-voltage battery may be reduced, even if the charging cable connector is connected.

When cooling, the following functions are activated as needed:

- Automatic climate control
- Blower

When heating, the following functions are activated as needed:

- Automatic climate control
- Blower
- Seat heating
- Mirror heater
- Rear window defroster

## Setting pre-entry climate control at departure time

Multimedia system:

➔ Vehicle ➔  Climate Control ➔ Pre-entry Climate Ctrl.

### Activating or deactivating pre-entry climate control at departure time

- ▶ Select [At Departure Time](#).
- ▶ Activate  or deactivate  the function.

### Setting the departure time

- ▶ Select [Set Departure Time](#).
- ▶ Set the desired time.
- ⓘ For further information about departure times, see (→ page 18).

### Selecting the zone

- ▶ Select [Select Zone](#).
- ▶ Select [Entire Vehicle](#) or [Driver's Seat Only](#).

## Activating/deactivating pre-entry climate control at departure time

### Requirements

- The high-voltage battery is charged sufficiently.
- The function has been activated via the multimedia system.

▶ **To activate:** set the departure time (→ page 12).

Pre-entry climate control at departure time is activated for a maximum of 55 minutes before the selected departure time. It remains active for another five minutes if the departure is delayed.

▶ **To deactivate:** press the  button up or down.

The following functions remain active after the vehicle has been started:

- Seat heating

## Activating/deactivating immediate pre-entry climate control

**⚠ WARNING** Risk of fatal injury due to exposure to extreme heat or cold in the vehicle

If people – particularly children – are exposed to extreme temperatures over an extended period of time, there is a risk of serious or even fatal injury.

- ▶ Never leave anyone – particularly children – unattended in the vehicle.
- ▶ Never leave animals in the vehicle unattended.

The vehicle interior can continue to be cooled or heated for up to 50 minutes, e.g. if the journey is interrupted.

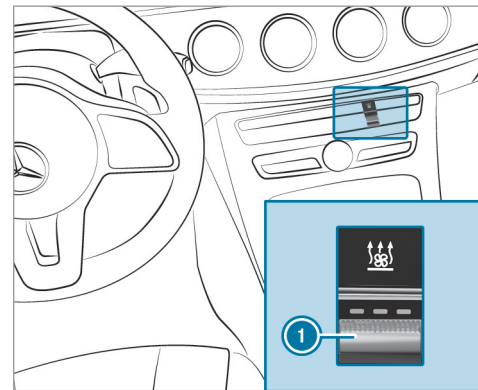

The indicator lamp colors have the following meaning:

- **blue:** cooling activated
- **red:** heating activated
- **yellow:** departure time is preselected

▶ Set the desired temperature using the  button.

- ▶ Press button ①.  
The red or blue indicator lamp on button ① lights up or goes out.



## Functions of the operating modes

The operating mode determines the drive type of the plug-in hybrid vehicle.

### The following operating modes are available:

HYBRID	For economical driving with availability of all hybrid functions <ul style="list-style-type: none"><li>• Default setting when starting the vehicle.</li><li>• All drive types (combustion engine, electric drive, boost and recuperation) are available.</li><li>• The hybrid system selects the most suitable drive type according to the driving situation and road conditions.</li></ul>
E-MODE	Driving by electric propulsion only <ul style="list-style-type: none"><li>• Driving by electric propulsion is possible up to the pressure point of the haptic accelerator pedal.</li><li>• Beyond the pressure point of the haptic accelerator pedal, the combustion engine is activated.</li><li>• Use: in inner city/low emission zone or when the charge level of the battery permits use of the electric drive.</li></ul>

E-SAVE	<p>The charge level of the battery is maintained</p> <ul style="list-style-type: none"> <li>• Use of the electric drive and boost is restricted.</li> <li>• The charge level of the high-voltage battery is maintained, e.g. for subsequent use in the inner city/low emission zone.</li> </ul>
CHARGE	<p>The battery is charged by the combustion engine while driving</p> <ul style="list-style-type: none"> <li>• Only the combustion engine is available. The electric motor is operating as an alternator. Consumption increases.</li> <li>• Use: if a high battery charge level is required for sections of the journey ahead.</li> </ul>

- In drive programs **C** and **E** all operating modes are available.
- The HYBRID operating mode is active during manual gearshifting.
- In the automatic drive program **S** the HYBRID operating mode is active.
- The combustion engine is not yet at operating temperature.
- The outside temperature is too high or too low.
- The self-diagnosis functions are active.

### System limitations

An operating mode may not be available under the following circumstances:

- The high-voltage battery's charge level is too high or too low.

## Switching operating mode

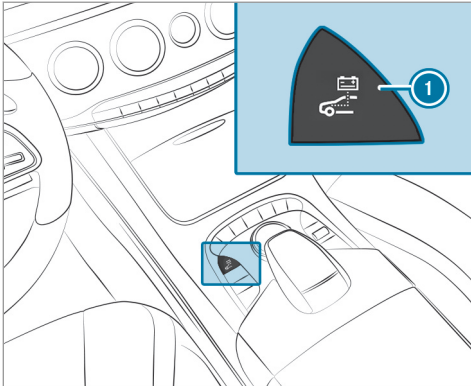

- ▶ Press button ① repeatedly until the desired operating mode is selected.

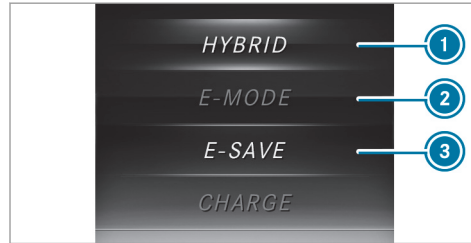

- ① Operating mode selected
- ② Operating mode unavailable
- ③ Operating mode available

## Configuring settings for plug-in hybrid vehicles

Multimedia system:

➤ Vehicle ➤  Hybrid

### Starting the charging process

- ▶ Select **Charging Settings**.
  - ▶ **To start the charging process immediately:** select **Charge Immediately**.
  - ▶ **To start the charging process in time for the departure time:** select **At Departure Time**.
- i** The charging process starts so that your vehicle will be fully charged, or charged as much as possible, at the specified departure time.

### Setting the departure time

- ▶ Select **Edit Once-only Time**.
  - ▶ Set a single departure time.
- or
- ▶ Select **Week Profile**.

- ▶ Set the departure times for the week profile, e.g. every day at 7:30 a.m.
- i** You can use the **Pre-entry Climate Ctrl.** menu entry to jump directly to the departure time setting for the pre-entry climate control (→ page 12).

**To create an electricity price profile:** you can establish an electricity price profile via the Mercedes me connect app. The charging process will then automatically take place at the most favorable time. Further information can be found in the separate Operating Instructions under [http://manuals.daimler.com/baix/cars/connectme/en\\_GB/index.html](http://manuals.daimler.com/baix/cars/connectme/en_GB/index.html).

- i** The creation of an electricity price profile is country-dependent and may not be available in your country.

### Displaying the consumption chart

- ▶ Select **Consumption**.
- The following information is displayed in the consumption chart:
- The amount of fuel used in the last time intervals

- Recuperation performance
- Electrical consumption

### Setting the maximum charge current

- i** The notes in the High-voltage battery section must be strictly observed before setting the charging current (→ page 29).
  - i** The option of setting the maximum charging current is country-dependent and may not be available in your country.
- ▶ Select **Max. Charge Current**.

The following menus are available:

- **Maximum**
  - **8 Amps**
  - **6 Amps**
- ▶ Select the desired setting.

## Functions of the energy flow display

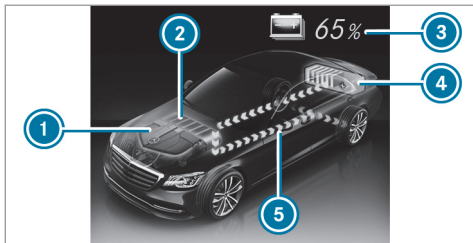

- ① Combustion engine
- ② Electric motor
- ③ Charge level of the high-voltage battery
- ④ High-voltage battery
- ⑤ Energy flow

The active components of the hybrid system are highlighted in the energy flow display. The energy flow between the individual components is shown in color.

The energy flow is shown in different colors depending on the operating status:

- **White:** constant energy flow
- **Red:** high energy flow (boost effect)
- **Green:** low-emission energy flow in the case of recuperation, electric mode and when charging the high-voltage battery

## Showing the energy flow display

Multimedia system:

↳ Vehicle »  Hybrid

▶ Select **Energy Flow**.  
The energy flow is displayed.

ⓘ For further information on the energy flow display, see (→ page 19).

## Notes on the Instrument Display and on-board computer



**⚠ WARNING** Risk of accident due to an instrument cluster malfunction

If the instrument cluster has failed or is malfunctioning, you may not recognize function restrictions applicable to safety relevant systems.

The operating safety of your vehicle may be impaired.

▶ Park the vehicle safely as soon as possible and notify a qualified specialist workshop.

Additional notes on your plug-in hybrid vehicle:

- Additional displays on the multifunction display:
  -  Drive is activated
  -  Operating mode, displays other operating modes (→ page 17)
  -  Electric range

- Haptic accelerator pedal (→ page 22) (→ page 34)
-  Acoustic presence indicator inoperative (→ page 44)

Additional displays on the **Trip** menu:

- Electric range
- Trip computer **From Start** and **From Reset**



Example: trip computer

- ① Driving time and distance covered electrically
- ② Electrical consumption

You can call up the coolant temperature display on the **Service** menu.

## DYNAMIC SELECT switch

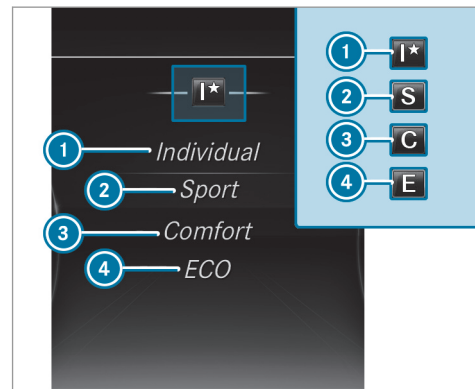

### Function of the DYNAMIC SELECT switch



Use the DYNAMIC SELECT switch to change the drive program. Depending on the drive program selected, the following vehicle characteristics will change:

- Drive
- Suspension
- Steering
- Availability of double pulses in the haptic accelerator pedal (ECO Assistant)

#### Available drive programs:

<p>①  (Individual)</p>	<p>Individual settings for the following vehicle characteristics:</p> <ul style="list-style-type: none"> <li>• Drive</li> <li>• Suspension</li> <li>• Steering</li> <li>• Double pulses in the haptic accelerator pedal (ECO Assistant)</li> </ul>
<p>②  (Sport)</p>	<ul style="list-style-type: none"> <li>• Sporty driving with boost effect</li> <li>• Electric-only mode is not possible</li> </ul>

<p>3 <b>C</b> (Comfort)</p>	<ul style="list-style-type: none"> <li>• Comfortable and economical driving</li> <li>• Electric-only mode is possible</li> <li>• The coasting characteristics of the vehicle are adapted to the traffic conditions</li> </ul>
<p>4 <b>E</b> (Economy)</p>	<ul style="list-style-type: none"> <li>• Particularly economical driving</li> <li>• Electric mode is used as often as possible</li> <li>• Double pulses in the haptic accelerator pedal (ECO Assistant)</li> <li>• The coasting characteristics of the vehicle are adapted to the traffic conditions</li> <li>• Electric-only overrun mode up to 100 mph (160 km/h) is possible</li> </ul>

### Configuring drive program I

Multimedia system:

↳ Vehicle ▶  DYNAMIC  
SELECT ▶ Individual

▶ Select the individual setting.

### Haptic accelerator pedal function

The haptic accelerator pedal helps you to reduce fuel consumption:

- through an additional point of resistance
- through a noticeable double pulse

Characteristics of the additional point of resistance:

- it indicates the maximum available electric performance

- it is used when the electric motor (POWER) power display is full
- it is only available in operating mode E-MODE

Characteristics of the double pulse:

- it indicates the optimum moment to release the accelerator pedal
- it is only available in drive programs **E** and **1\***. The haptic accelerator pedal must be activated in drive program **1\***.



### Function of the power display of the electric motor



- Area ① - ② shows the output in electric mode or boost effect. The POWER display supports you in electric-only mode.
- Area ③ - ④ shows the recuperated output.
- From point ④, the maximum recuperated output has been reached. During greater deceleration, the mechanical service brake intervenes increasingly to decelerate the vehicle.
- The current charge level of high-voltage battery ⑤ is displayed.

### Function of the power meter

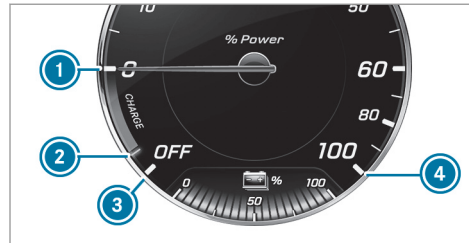

- The power meter supports you in electric-only mode and displays the power obtained from the hybrid system.
- Recuperated energy is shown in area ① - ②.
- When the power meter needle is on position ③, the vehicle is switched off. The combustion engine and the electric motor are switched off.
- Power range ① - ④ shows the combined output of the hybrid system.

### Displaying the power meter

- ▶ Navigate up or down with Touch Control on the left-hand side of the steering wheel until the power meter is displayed.

Observe the notes on Touch Control in the vehicle Operator's Manual.

### Function of the route-based operating-mode strategy

When route guidance is active, data on the planned route is analyzed.

The multimedia system provides the following data:

- Road categories
- Speed limitations
- Height data

The hybrid system adjusts the operating-mode strategy accordingly:

- The use of electrical energy and the combustion engine are distributed in the best possible way.

- The vehicle automatically selects the best possible operating mode.
- The charge level of the high-voltage battery is controlled accordingly.
- The electrical energy is reserved especially for electric mode, e.g. urban route sections and environmental zones.

### Activating route-based operating-mode strategy (ROS)

#### Requirements:

- Active route guidance is activated.
  - Suitable map data is available.
- ▶ Press the DYNAMIC SELECT switch repeatedly until drive program **E** is selected.
  - ▶ Press the operating mode button repeatedly until HYBRID operating mode is selected. The area in front of the vehicle is shown as green in the multifunction display while the vehicle is in motion.

## Notes on high-voltage battery

### Charging options for the high-voltage battery:

While the vehicle is in motion by means of:

- Energy recuperation
- Combustion engine (CHARGE operating mode)

Stationary charging via:

- Mains socket (mode 2)
- Wallbox (mode 3)
- Charging station (mode 3)

The high-voltage battery can be charged in a nominal voltage range from 100 V to 400 V.

### System limitations

The power output of the high-voltage battery may be impaired by the following:

- High or low outside temperatures
- Switching on consumers
- Operating the climate control system
- Extended periods without charging

The charge time of the high-voltage battery may be increased by the following:

- High or low outside temperatures
- Extended periods without charging
- The maximum available charging current from the mains supply
- The charging current set on the charging cable or via the on-board computer

### Checking the charge level of the high-voltage battery

**!** **NOTE** Damage from exhaustive discharging of the high-voltage battery

Exhaustive discharge caused by the battery being idle for lengthy periods can damage the high-voltage battery.

**▶ Plug-in hybrid vehicles:** if the vehicle is idle for lengthy periods, leave the high-voltage battery connected to power supply equipment.

Options for checking the charge level of the high-voltage battery:

- ▶ In the multifunction display
- ▶ In the multimedia system display

### Function of the indicator lamp on the vehicle socket

- The vehicle socket is located on the right-hand side of the rear bumper.
- The socket flap is centrally locked and unlocked together with the vehicle.

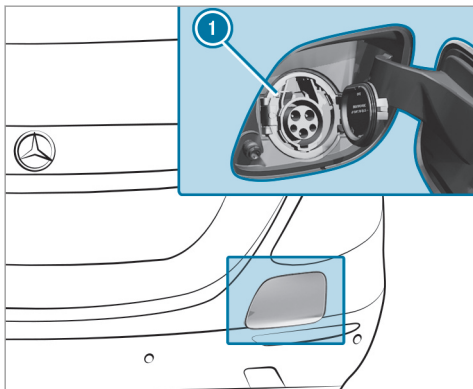

① Status of the charging process

### Overview of the indicator lamp status

Status of charging process ①	Display	Meaning
	Flashes orange	Connection is being established
	Flashes green	Charging process
	Lights up orange	Interruption in charging
	Lights up green	High voltage battery fully charged
	Flashes red	Malfunction

### Notes on charging the high-voltage battery at the mains socket (mode 2)

**⚠ DANGER** Risk of fatal injury from incorrectly installed component parts

Connecting the charging cable to the mains supply via incorrectly installed mains sockets or by means of adapters, extension cables or similar could cause a fire or an electric shock.

- ▶ Only connect the charging cable to a mains socket that:
  - Has been properly installed and
  - Has been inspected by a qualified electrician
- ▶ For safety reasons, only use the charging cables supplied with the vehicle, or charging cables which have been approved for use with this vehicle.
- ▶ Never use a damaged charging cable.
- ▶ Do not use:

- Extension cables
- Extension reels
- Multiple sockets

- ▶ Never use socket adapters to connect the charging cable to the mains socket. The only exception being if the adapter has been tested and approved by the manufacturer for charging the high-voltage battery of an electric vehicle.
- ▶ Observe the safety notes in the operating instructions for the socket adapter.

Only the following charging cables may be used:

- The charging cable supplied with the vehicle.
- A charging cable that has been approved for the vehicle.

The charging process can vary depending on the power supply equipment.

Short charging times can be achieved:

- At a wallbox.
- At a charging station.

When doing so, always observe the local information.

Do not leave the charging cable controls hanging loose from a mains socket.

Do not lift the controls by the following component parts:

- The charging cable connector.
- The mains plug.

The charging cable should be stowed and held in place in the bag provided in the trunk of the vehicle.

### Overview of the charging cable control panel, version 1

The charging cable control panel shows the current status of the charging process.

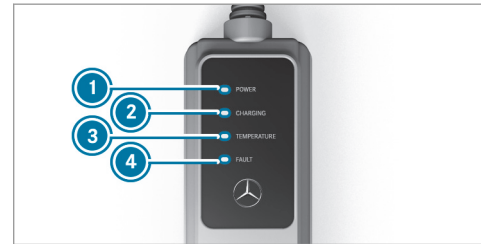

- ① POWER: supply voltage indicator
- ② CHARGING: charging process indicator
- ③ TEMPERATURE: temperature control indicator
- ④ FAULT: protection and control system indicator

#### POWER

① Supply voltage indicator	Meaning
Lights up green	The supply voltage is connected

**CHARGING**

<b>② Charging process indicator</b>	<b>Meaning</b>
Flashes blue	High-voltage battery is charging

**TEMPERATURE**

<b>③ Temperature control indicator</b>	<b>Meaning</b>
Lights up orange	If the blue LED flashes simultaneously: the charging performance is reduced due to excess temperature. Without flashing blue LED: charging is canceled at the ICCB due to excess temperature.
Flashes orange	The charging process is canceled at the mains socket due to excess temperature.

**FAULT**

<b>④ Protection and control system indicator</b>	<b>Meaning</b>
Flashes red	There is an internal malfunction. The high-voltage battery cannot be charged.
Lights up red	There is an infrastructure malfunction. The high-voltage battery cannot be charged.

If the control element detects residual current or a malfunction, the charging process is interrupted. The charging process is resumed automatically when the malfunction has been rectified.

### Setting the maximum permissible charging current for charging at a mains socket

**!** **NOTE** If the charging current is too high, the fuse could be tripped or the external mains supply could overheat.

- ▶ Check that the external mains supply has been designed to handle the set charging current.
- ▶ If necessary, reduce the set charging current or use a different mains socket.

- ▶ Before charging the high-voltage battery at a mains socket, check the maximum permissible charging current for the relevant mains socket or the building. The charging cable supplied is set to a country-specific maximum charging current value. When charging abroad, the maximum value may exceed the permitted value for that country. When abroad, observe the country-specific laws when charging.  
If you have questions concerning setting the charging current or if there is a malfunction,

please contact a qualified specialist workshop.

You can set the maximum permissible charging current as follows:

- On the controls of the charging cable (charging cable version 2).
- In the multimedia system menu.

The smaller value of the two charging current settings – on the controls of the charging cable and in the multimedia system – determines the maximum charging current. If the exact value of the maximum permissible charging current cannot be set, select the next smaller adjustable value.

Set the maximum permissible charging current in the multimedia system menu only in the following circumstances:

- It is not possible to set the charging current on the charging cable (charging cable version 1).
- The precise value of the maximum permitted charging current can only be set via the multimedia system.

- ⓘ If the vehicle requires more time than usual when charging the high-voltage battery, check the maximum charging current settings using the controls on the charging cable or in the menu of the multimedia system.

### Setting on the controls of charging cable version 2

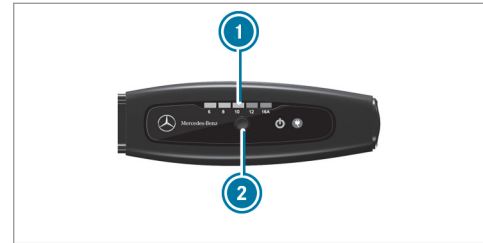

- ▶ Insert the mains plug into the mains socket.

The charging current must be set within one minute of inserting the mains plug into the mains socket.

- ▶ Press button ②.  
Selected charging current ① flashes green for around ten seconds and then lights up continuously.
- ▶ Repeat the process until the desired charging current setting is selected.  
If the LEDs light up orange for a value, this indicates that this charging current cannot be selected for this mains socket.
- ① Once the time has elapsed, the charging current setting can only be changed by restarting the process. Disconnect the charging cable from the mains supply and then reconnect it.  
If you disconnect the charging cable from the mains socket after the charging process, the charging current setting is deleted. The next charging process will start with the minimum value.

### Notes on charging the high-voltage battery at a wallbox (mode 3)

**⚠ DANGER** Risk of fatal injury from incorrectly installed component parts

Connecting the charging cable to the vehicle via an incorrectly installed wallbox or by means of adapters, extension cables or similar could cause a fire or an electric shock.

- ▶ Only connect the charging cable to a wallbox if:
  - The wallbox has been properly installed
  - The wallbox has been inspected by a qualified electrician
  - The charging cable is not damaged
- ▶ Do not extend the charging cable.
- ▶ Do not use adapters.
- ▶ Observe the safety notes in the operating instructions for the wallbox.

It is recommended that you charge your vehicle at a wallbox or charging station.

Make sure that:

- The maximum charging current is not limited in the settings menu of the on-board computer.
- The maximum value is set for charging at a wallbox or charging station.

### Notes on charging the high-voltage battery at a charging station (mode 3)

**⚠ DANGER** Risk of fatal injury from incorrectly installed component parts

Connecting the charging cable to the vehicle via an incorrectly installed wallbox or by means of adapters, extension cables or similar could cause a fire or an electric shock.

- ▶ Only connect the charging cable to a wallbox if:
  - The wallbox has been properly installed
  - The wallbox has been inspected by a qualified electrician
  - The charging cable is not damaged



- ▶ Do not extend the charging cable.
- ▶ Do not use adapters.
- ▶ Observe the safety notes in the operating instructions for the wallbox.

Most charging stations must be activated before the charging process, e.g. using an RFID card. Observe the on-site operator's instructions for the charging station.

Connecting the vehicle to a charging station is identical to connecting it to a wallbox.

### Starting the charging process

#### Requirements:

- The transmission is in position **P**.
- The ignition is switched off.
- The vehicle is unlocked.
- The charging cable is not under tension.

#### **⚠ DANGER** Risk of fatal injury when charging with a damaged socket

The charging process involves high voltage. If the charging cable, vehicle socket or mains socket is damaged, you could suffer an electric shock.

- ▶ Only use an undamaged charging cable.
- ▶ Avoid mechanical damage, e.g. caused by squashing, shearing or driving over the cable.
- ▶ Have a damaged vehicle socket replaced at a qualified specialist workshop as soon as possible.
- ▶ Never connect the charging cable to a damaged vehicle socket.

#### **!** **NOTE** Overvoltage in the mains supply can damage the vehicle.

The vehicle is therefore equipped with a device which protects it from overvoltage in the mains supply. This device may be triggered during severe thunderstorms, for

example, and may cause the building protection system to trip out or may interrupt the charging process. These functions help to protect the vehicle.

After the building protection system has been switched on again, the charging process resumes automatically.

If the charging process has been interrupted but the building protection system has not tripped out, it may take up to 10 minutes before the charging process resumes automatically.

#### **!** **NOTE** Heat generated by the charging cable and charging cable connector

During the charging process, the charging cable and charging cable connector may heat up within permissible limit values.

The permissible limit values are observed provided that:

- The mains power supply equipment and the charging cable are not damaged.

- The instructions for handling the charging cable and controls on the charging cable have been followed.
- ▶ If the charging cable or charging cable connector becomes too hot, have the mains power supply equipment checked.

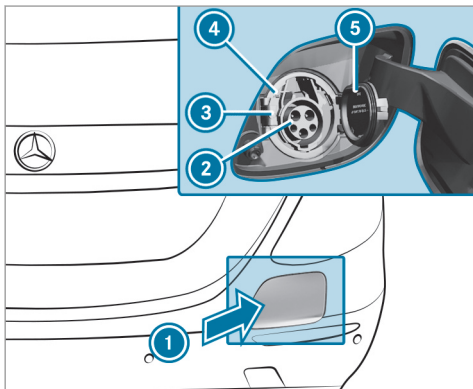

- ▶ Press socket flap ①. Socket flap ① swings open.
- ▶ Press catch ③ to the left. Socket cover ⑤ is open.
- ▶ **Charging at a mains socket (mode 2):** insert the mains plug into the mains socket of the external power source to the stop.
- ▶ Set the maximum charging current if required.
- ▶ Insert the charging cable connector into vehicle socket ② to the stop. Make sure that the charging cable is not taut when inserted.
- ▶ Indicator lamp ④ first flashes orange and then green as soon as the high-voltage battery is being charged.
- ▶ **Charging at a wallbox/charging station (mode 3):** insert the charging cable connector into vehicle socket ② to the stop. Make sure that the charging cable is not taut when inserted.

Indicator lamp ④ first flashes orange and then green as soon as the high-voltage battery is being charged.

If the charging cable is connected to the vehicle, the engine cannot be started and the vehicle cannot be moved.

At the start of the charging process, the charging side is shown in the instrument cluster with a charging prediction. The charging prediction either refers to the predicted charge level at the set departure time, or the time at which the high-voltage battery will be fully charged.

ⓘ Depending on the temperature, the fan and battery cooling system may audibly switch on during the charging process.

## Ending the charging process

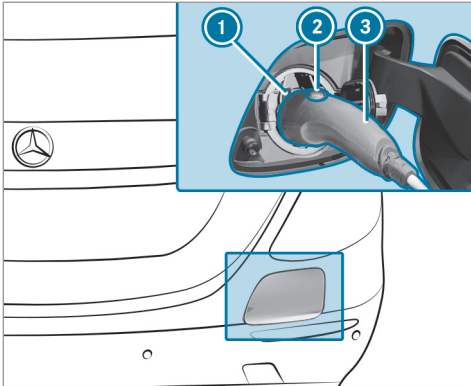

- ▶ Press and hold button ② on charging cable connector ③ and remove charging cable connector ③ from vehicle socket ①.
- ▶ **Charging at a mains socket (mode 2):** disconnect the mains plug from the mains socket and stow the charging cable safely in the vehicle.

## Driving

### ECO Assist function

ECO Assist analyzes data for the vehicle's expected route. This allows the system to optimally adjust the driving style for the route ahead, save fuel and recuperate. If the system detects an event ahead, e.g. a speed limit or a traffic circle, it will appear on the multifunction display **1**. The following symbols can be displayed:

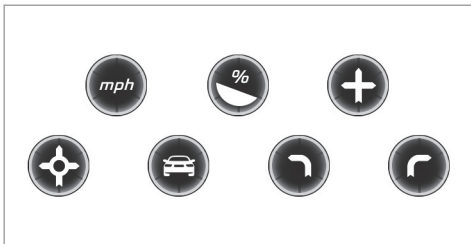

Not all events can be displayed, depending on the engine type.

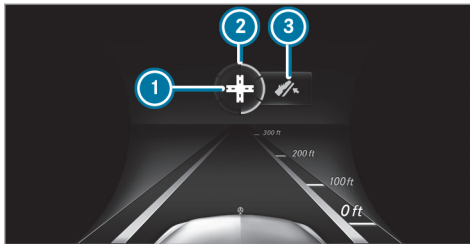

- 1** Event ahead
- 2** Distance to the event ahead
- 3** "Foot off the accelerator" prompt

A different number of segments **2** will appear around the symbol depending on the distance to the event ahead:

- Few segments: the event ahead is near.
- Many segments: the event ahead is further away.

When the vehicle nears the event, ECO Assist calculates the optimal speed for maximum fuel economy and recuperative energy based on the distance, speed and downhill gradient. The **Foot**

**off the Accelerator** message will appear on the multifunction display. If the driver lifts off the accelerator pedal in good time, the remaining segments on the display will turn green until the event shown is reached. The drivetrain will be set for maximum fuel economy. The vehicle will coast, with the combustion engine switched off if necessary, and recuperate on its own using the electric motor. Recuperation will charge the battery.

If there is no response to the **Foot off the Accelerator** prompt, the segments will remain white. The event will be shown for a short time after it has been passed.

If the event involves a vehicle ahead and when the coast-down recommendation is given, all segments will immediately turn green once there is a response to the **Foot off the Accelerator** prompt.

For Active ECO Assist in drive program **E**, symbol **3** will appear on the multifunction display and on the Head-up Display beside transmission position **D**. Symbol **3** will also appear when the assistant display is not selected.

The ECO Assist is active only in drive programs **E** and **C**.

### System limitations

ECO Assist can function more precisely if the route is maintained when route guidance is active. The basic function is also available without active route guidance. Not all information and traffic situations can be foreseen. The quality depends on the map data.

ECO Assist is only an aid. The driver is responsible for keeping a safe distance to the vehicle in front, for vehicle speed and for braking in good time. The driver must be ready to brake at all times irrespective of whether the system intervenes.

The system may be impaired or may not function in the following situations:

- If there is poor visibility, e.g. due to insufficient illumination of the road, highly variable shade conditions, or due to rain, snow, fog or heavy spray.
- If there is glare, e.g. from oncoming traffic, direct sunlight or reflections.

- If there is dirt on the windshield in the vicinity of the multifunction camera or the camera is fogged up, damaged or obscured.
- If the traffic signs are hard to detect, e.g. due to dirt or snow or insufficient lighting, or because they are covered.
- If the information on the navigation system's digital map is incorrect or out of date.
- If the signs are ambiguous, e.g. traffic signs on construction sites or in adjacent lanes.

### Displaying ECO Assist

On-board computer:

- ↳ Assistance
- ▶ Select ECO Assist.

### Refueling

#### Depressurizing the fuel tank

#### Requirements:

- Unlock the vehicle.

- ⓘ Do not get into the vehicle again during the refueling process. Otherwise, electrostatic charge could build up again.

Observe the notes on operating fluids (→ page 40).

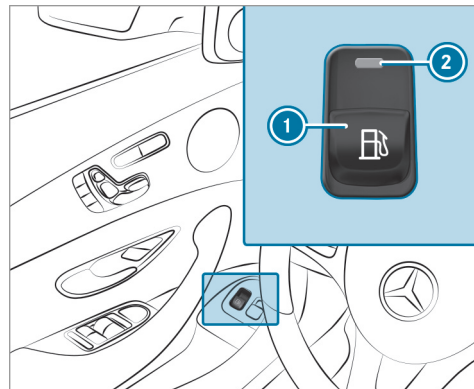

- ▶ Pull switch ①. Indicator lamp ② flashes and the **Please Wait Depressurizing Tank** message appears

in the multifunction display. The pressure in the high-pressure fuel tank is released.

If the fuel filler flap is open, indicator lamp ② lights up continuously.

The **Tank is Depressurized Ready for Refueling** message appears in the multifunction display.

- ① In the following situations there is a malfunction:
  - Indicator lamp ② flashes initially and then goes out
  - The yellow Check Engine warning lamp lights up
- ① The opening process for the fuel filler flap may take up to 15 minutes.

### TIREFIT kit storage location

The TIREFIT kit is located in the stowage space under the trunk floor.

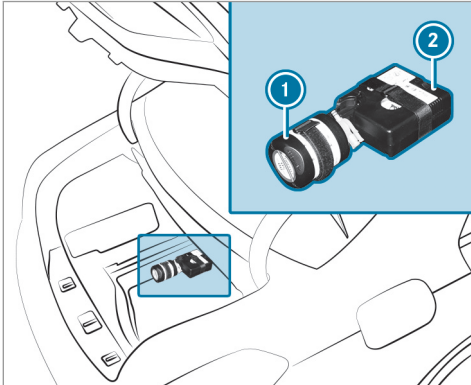

- ① Tire sealant bottle
- ② Tire inflation compressor

### Starting assistance

Observe the information on starting assistance in the vehicle Operator's Manual.

If your vehicle has been jump-started, it may not be possible to use the electric drive for approximately 30 minutes.

Starting assistance is not considered to be a normal operating condition.

Jumper cables and further information regarding starting assistance can be obtained at any qualified specialist workshop.

### Permitted towing methods

Mercedes-Benz recommends transporting your vehicle in the case of a breakdown, rather than towing it away.

For towing, use a tow rope or tow bar with both axles on the ground. Do not use tow bar systems .

**!** **NOTE** Damage to the vehicle due to towing away incorrectly

▶ Observe the instructions and notes on towing away.

Observe the information on towing and transporting the vehicle in the vehicle Operator's Manual.

## Permitted towing methods

Vehicle equipment/towing method	 Both axles on the ground	 Front axle raised	 Rear axle raised
Plug-in hybrid vehicles	Yes, maximum 31 miles (50 km) at 31 mph (50 km/h)	No	No

Only transporting is permitted in the following situations:

- The multifunction display is not working  
or
- The  **Towing Not Permitted See Operator's Manual** display message is shown

**Exception:** if the vehicle is located in a danger zone, it can be recovered from the danger zone despite the display message or the display not working.

It must not be towed further than 164 ft (50 m) with both axles on the ground. A towing speed of

6 mph (10 km/h) must not be exceeded. Beyond these limits, only transporting is permitted.



Vehicle identification plate, VIN and engine number overview

Vehicle identification plate

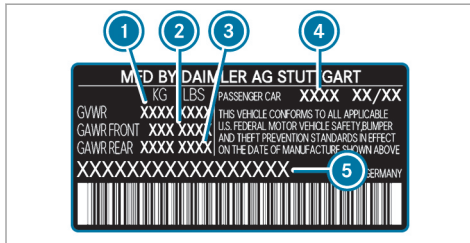
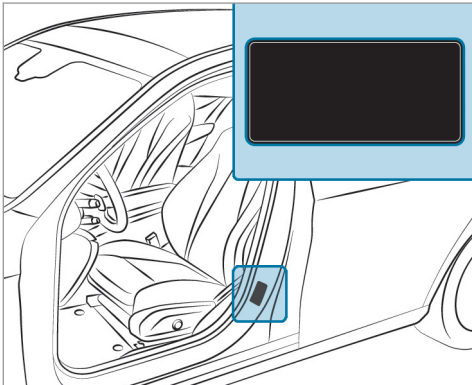

Vehicle identification plate (USA only)

- ① Permissible gross weight
- ② Permissible front axle load
- ③ Permissible rear axle load
- ④ Paint code
- ⑤ VIN (vehicle identification number)

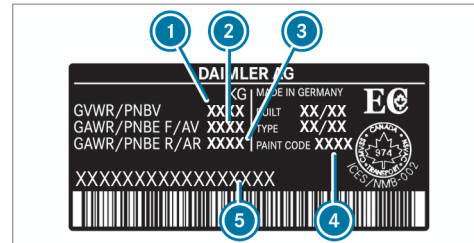

Vehicle identification plate (Canada only)

- ① Permissible gross weight
- ② Permissible front axle load
- ③ Permissible rear axle load
- ④ Paint code
- ⑤ VIN (vehicle identification number)

The permissible gross vehicle weight is made up of the vehicle weight, all vehicle occupants, the fuel and the load. The maximum gross axle weight rating is the maximum weight that can be carried on one axle (front or rear axle).

Never exceed the permissible gross vehicle weight or the maximum gross axle weight rating for the front or rear axle.

### VIN in front of the front seat

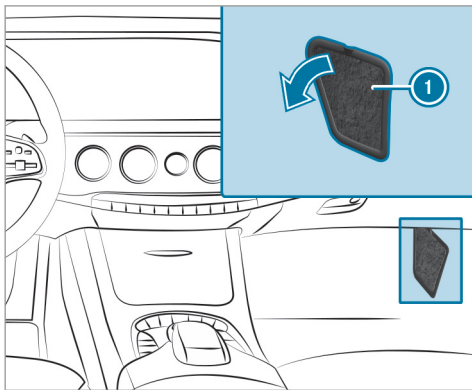

- ① VIN (vehicle identification number)

### Additional plates

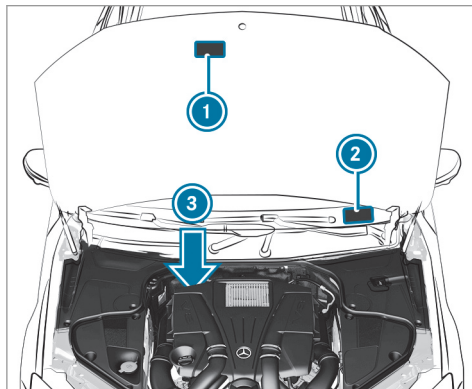

- ① Plate with information about emissions testing, including confirmation of emissions guidelines at the U.S. federal level as well as for California
- ② VIN (vehicle identification number)
- ③ Engine number (stamped into the crankcase)

## Operating fluids

### Tank content and fuel reserve

The total capacity of the fuel tank may vary, depending on the vehicle equipment.

Missing values were not available at time of going to print.

### Tank content and fuel reserve

Model	Total capacity
S 560 e	16.5 gal (63.0 liters)
Model	Of which reserve
S 560 e	2.1 gal (8.0 liters)

### Quality and capacity of engine oil

#### MB-Freigabe or MB-Approval

Model	MB-Freigabe or MB-Approval
S 560 e	229.5, 229.6

Only use SAE 0W-40 or SAE 5W-40 engine oils.

The following values refer to an oil change, including the oil filter.

### Capacity

Model	Capacity
S 560 e	6.9 US qt (6.5 liters)

### Coolant capacity

Model	Capacity
S 560 e	13.9 US qt (13.2 liters)

### Refrigerant filling capacity and PAG oil

Model	Refrigerant
S 560 e	25 ± 0.4 oz (710 ± 10 g)

Model	PAG oil
S 560 e	4.2 ± 0.4 oz (120 ± 10 g)

### Vehicle data

#### Vehicle dimensions

The heights specified may vary as a result of the:

- Tires
- Load
- Condition of the suspension
- Optional equipment

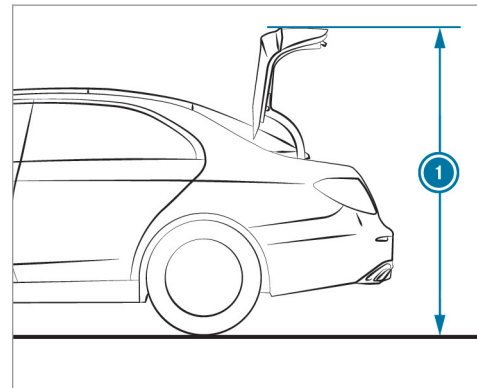

#### Height when opened

	① Height when opened
All models	71.0 in (1803 mm)

**Vehicle dimensions**

<b>S 560 e</b>	
Vehicle length	206.9 in (5255 mm)
Vehicle width including exterior mirrors	83.9 in (2130 mm)
Vehicle width without exterior mirrors	74.8 in (1899 mm)
Vehicle height	58.8 in (1494 mm)
Wheelbase	124.6 in (3165 mm)

**Weights and loads**

Please note that for the specified vehicle data:

- Items of optional equipment increase the curb weight and reduce the payload.

**S 560 e**

Maximum roof load	220 lb (100 kg)
-------------------	-----------------

**Technical data of the high-voltage battery****High-voltage battery**

<b>Models</b>	
Model	Lithium-ion
Energy content (gross)	13.8 kWh
Range in electric-only mode (according to NEDC)	approximately 50 km
Charging duration – mode 3 (from 20% to 100%) at 2x (16 A)/ (230 V) or 3x (16 A)/ (230 V) (on a wallbox or charging station)	approximately 1 h 30 min

**Models**

Charging duration – mode 2 (from 20% to 100%) at (16 A)/ (230 V) (on a CEE mains outlet)	approximately 3 h
Charging duration – mode 2 (from 20% to 100%) at (8 A)/ (230 V) (in a household socket)	approximately 6 h 30 min

## Display messages

### Safety systems

#### Display messages



SRS Malfunction Service  
Required

#### Possible causes/consequences and ► Solutions

\* The restraint system is defective .



#### **⚠ DANGER** Risk of fatal injuries due to the restraint system malfunctioning

If the restraint system is malfunctioning, restraint system components may be triggered unintentionally or may not deploy as intended during an accident. This may affect the Emergency Tensioning Device or airbag, for example. Furthermore, in the event of an accident, the high-voltage on-board electrical system may not be deactivated as intended.

You may be electrocuted if you touch the damaged component parts of the high-voltage on-board electrical system.



- Have the restraint system checked and repaired immediately at a qualified specialist workshop.
- After an accident, switch off the ignition immediately.

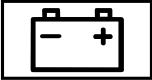
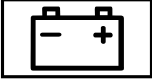

Detection of a restraint system malfunction:

- The  restraint system warning lamp does not light up when the ignition is switched on.
  - The  restraint system warning lamp lights up continuously or repeatedly during a journey.
- Visit a qualified specialist workshop immediately.

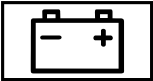

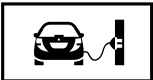

## Hybrid system

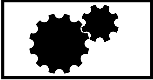

Display messages	Possible causes/consequences and ► Solutions
 <p data-bbox="57 350 345 379">See Operator's Manual</p>	<p data-bbox="466 236 1026 265">* The battery will not be sufficiently charged.</p> <div data-bbox="492 288 1917 439" style="border: 1px solid gray; padding: 5px;"> <p data-bbox="513 298 1230 327"><b>!</b> <b>NOTE</b> Possible engine damage if you continue driving</p> <ul style="list-style-type: none"> <li data-bbox="513 350 1173 379">► Do not continue driving under any circumstances.</li> <li data-bbox="513 391 1046 420">► Consult a qualified specialist workshop.</li> </ul> </div> <ul style="list-style-type: none"> <li data-bbox="492 456 1888 485">► Pull over and stop the vehicle safely and switch off the engine, paying attention to road and traffic conditions.</li> <li data-bbox="492 498 1026 527">► Consult a qualified specialist workshop.</li> </ul>
 <p data-bbox="57 663 345 692">See Operator's Manual</p>	<p data-bbox="466 549 899 578">* The battery is not being charged.</p> <div data-bbox="492 600 1917 752" style="border: 1px solid gray; padding: 5px;"> <p data-bbox="513 611 1230 640"><b>!</b> <b>NOTE</b> Possible engine damage if you continue driving</p> <ul style="list-style-type: none"> <li data-bbox="513 663 1173 692">► Do not continue driving under any circumstances.</li> <li data-bbox="513 704 1046 733">► Consult a qualified specialist workshop.</li> </ul> </div> <ul style="list-style-type: none"> <li data-bbox="492 769 1888 798">► Pull over and stop the vehicle safely and switch off the engine, paying attention to road and traffic conditions.</li> <li data-bbox="492 811 1026 840">► Consult a qualified specialist workshop.</li> </ul>

Display messages	Possible causes/consequences and ► Solutions
 <p data-bbox="118 301 451 363">Stop Vehicle Leave Engine Running</p>	<ul style="list-style-type: none"> <li data-bbox="527 184 1255 215">* The battery charge level is too low and must be charged.               <ul style="list-style-type: none"> <li data-bbox="553 225 1974 291">► Pull over and stop the vehicle safely as soon as possible, paying attention to road and traffic conditions. Do not continue driving under any circumstances.</li> <li data-bbox="553 301 809 332">► Set READY state.</li> <li data-bbox="553 342 1371 373">► Wait until the display message disappears before pulling away.</li> </ul> </li> </ul>
 <p data-bbox="118 508 396 570">Tank is Depressurized Ready for Refueling</p>	<ul style="list-style-type: none"> <li data-bbox="527 391 1412 422">* The pressure in the fuel tank is released and the fuel filler flap opens.</li> </ul>
 <p data-bbox="118 700 441 731">Charger Cable Connected</p>	<ul style="list-style-type: none"> <li data-bbox="527 583 1295 614">* You cannot pull away while the charging cable is connected.</li> </ul>
<p data-bbox="118 755 466 884">Change the current drive program before changing the operating mode. (Example)</p>	<ul style="list-style-type: none"> <li data-bbox="527 743 1459 774">* The operating mode can be changed only in drive program <b>C</b> or <b>E</b>.</li> </ul>



Display messages	Possible causes/consequences and ► Solutions
 <p data-bbox="57 301 384 362">Towing Not Permitted See Operator's Manual</p>	<ul style="list-style-type: none"> <li data-bbox="466 184 1289 256">* The hybrid system is malfunctioning.               <ul style="list-style-type: none"> <li data-bbox="492 225 1289 256">► Only have the vehicle transported on a transporter or trailer .</li> </ul> </li> </ul>
 <p data-bbox="57 495 396 556">Please Wait Depressurizing Tank</p>	<ul style="list-style-type: none"> <li data-bbox="466 382 1913 443">* The pressure in the fuel tank is released before the fuel filler flap is opened. The pressure release process can take up to 15 minutes.</li> </ul>
<p data-bbox="57 581 404 642">E-MODE Currently Unavailable</p>	<ul style="list-style-type: none"> <li data-bbox="466 574 1923 743">* The charge level of the high-voltage battery has reached the lower limit. The operating mode switches automatically from E-MODE to HYBRID. The driving mode with the internal combustion engine is activated.               <ul style="list-style-type: none"> <li data-bbox="492 647 1917 743">► If necessary, select the CHARGE operating mode (→ page 17). The high-voltage battery is then charged while driving. When the charge level of the high-voltage battery is sufficient, the E-MODE operating mode is available again.</li> </ul> </li> </ul>
<p data-bbox="57 767 333 828">Engine will not restart Service required</p>	<ul style="list-style-type: none"> <li data-bbox="466 762 1555 831">* The engine cannot be restarted due to a malfunction.               <ul style="list-style-type: none"> <li data-bbox="492 800 1555 831">► Do not switch off the engine; drive on to the nearest qualified specialist workshop.</li> </ul> </li> </ul>



Display messages	Possible causes/consequences and ► Solutions
 <p data-bbox="118 301 269 329">Malfunction</p>	<ul style="list-style-type: none"> <li data-bbox="523 184 1455 215">* The hybrid system is defective. The drive power of your vehicle is limited.</li> <li data-bbox="553 225 1050 256">► Visit a qualified specialist workshop.</li> </ul>
 <p data-bbox="118 462 429 521">Cannot Start Engine See Operator's Manual</p>	<ul style="list-style-type: none"> <li data-bbox="523 350 1602 381">* The high-voltage battery's charge level is too low. You can no longer start the engine.</li> <li data-bbox="553 391 1263 422">► Switch off electrical consumers that are not required.</li> <li data-bbox="553 433 1201 464">► Charge the high-voltage battery when stationary.</li> </ul>
 <p data-bbox="118 657 445 716">Acoustic Presence Indicator Inoperative</p>	<ul style="list-style-type: none"> <li data-bbox="523 540 1941 602">* The acoustic presence indicator is malfunctioning. No driving noises are produced. As a result, your vehicle may not be heard by other road users in certain situations.</li> <li data-bbox="553 613 919 644">► Drive with particular care.</li> <li data-bbox="553 654 1050 685">► Visit a qualified specialist workshop.</li> </ul>
 <p data-bbox="118 848 367 907">Malfunction Service Required</p>	<ul style="list-style-type: none"> <li data-bbox="523 731 1005 762">* The hybrid system is malfunctioning.</li> <li data-bbox="553 772 1050 803">► Visit a qualified specialist workshop.</li> </ul>

Display messages	Possible causes/consequences and ► Solutions
<p data-bbox="57 194 349 288">Only E-MODE Available Power Limited Refuel Immediately</p>	<p data-bbox="466 184 1821 246">* The fuel tank is empty and the combustion engine is switched off. The drive power of your vehicle is limited because you are driving in electric mode.</p> <ul data-bbox="492 260 778 288" style="list-style-type: none"><li data-bbox="492 260 778 288">► Refuel immediately.</li></ul>
 <p data-bbox="57 422 376 484">Tank Ventilation Malfunction Service Required</p>	<p data-bbox="466 306 1003 334">* There is a malfunction in the fuel system.</p> <ul data-bbox="492 348 983 376" style="list-style-type: none"><li data-bbox="492 348 983 376">► Visit a qualified specialist workshop.</li></ul>
 <p data-bbox="57 616 349 678">Stop Vehicle Shift to 'P' Leave Engine Running</p>	<p data-bbox="466 500 1116 528">* Undersupply of the HV on-board electrical system.</p> <p data-bbox="492 541 840 569">Perform the following steps:</p> <ul data-bbox="492 583 1142 700" style="list-style-type: none"><li data-bbox="492 583 905 611">► Pull over and stop the vehicle.</li><li data-bbox="492 624 656 652">► Shift to P.</li><li data-bbox="492 666 1142 694">► Let the engine idle until the message disappears.</li></ul>

## Vehicle

Display messages	Possible causes/consequences and ► Solutions
 <p data-bbox="118 350 439 445">Pre-entry Climate Control via Key Inoperative High-voltage Battery Low</p>	<ul style="list-style-type: none"> <li>* The charge of the high-voltage battery is too low. Pre-entry climate control cannot be switched on.           <ul style="list-style-type: none"> <li>► Charge the high-voltage battery.</li> <li>► Select the CHARGE operating mode (→ page 15). When the high-voltage battery is sufficiently charged, pre-entry climate control is operational again.</li> </ul> </li> </ul>
 <p data-bbox="118 578 439 673">Pre-entry Climate Control via Key Available Again After Engine Start</p>	<ul style="list-style-type: none"> <li>* You have attempted to switch on pre-entry climate control more than twice with the engine switched off.           <ul style="list-style-type: none"> <li>► Activate READY for 10 seconds. Pre-entry climate control is operational again.</li> </ul> </li> </ul>
 <p data-bbox="118 806 459 859">Inoperative Charge HV Battery</p>	<ul style="list-style-type: none"> <li>* The charge of the high-voltage battery is too low. Pre-entry climate control cannot be switched on.           <ul style="list-style-type: none"> <li>► Charge the high-voltage battery.</li> </ul> </li> </ul>

**Display messages**



Inoperative High-Voltage  
Battery Charging Not Com-  
plete

**Possible causes/consequences and ► Solutions**

- \* The high-voltage battery is charging. Pre-entry climate control cannot be switched on.
  - Wait until the charging process is complete.

## Warning and indicator lamps

## Safety systems

Warning/indicator lamp	Possible causes/consequences and ► Solutions
<div data-bbox="130 291 324 391" data-label="Image"> </div> <p data-bbox="118 401 435 464">RBS warning lamp (USA/CND)</p>	<p data-bbox="502 285 1273 317">The yellow RBS warning lamp is lit while the engine is running.</p> <div data-bbox="502 339 1984 529" data-label="Complex-Block" style="border: 1px solid gray; padding: 5px;"> <p data-bbox="519 350 1391 381"><b>▲ WARNING</b> Risk of an accident due to a brake system malfunction</p> <p data-bbox="519 399 1500 430">If the brake system is malfunctioning, braking characteristics may be impaired.</p> <ul data-bbox="519 443 1549 515" style="list-style-type: none"> <li data-bbox="519 443 793 474">▶ Drive on carefully.</li> <li data-bbox="519 484 1549 515">▶ Have the brake system checked immediately at a qualified specialist workshop.</li> </ul> </div> <ul data-bbox="502 550 1774 664" style="list-style-type: none"> <li data-bbox="502 550 1774 581">▶ Adjust your speed and continue to drive carefully, leaving a suitable distance to the vehicle in front.</li> <li data-bbox="502 591 1459 622">▶ If the multifunction display shows a display message, please observe this.</li> <li data-bbox="502 632 997 664">▶ Visit a qualified specialist workshop.</li> </ul>

## Warning/indicator lamp



Restraint system warning lamp

## Possible causes/consequences and ► Solutions

The red restraint system warning lamp is lit while the engine is running.  
The restraint system is malfunctioning .

**⚠ DANGER** Risk of fatal injuries due to the restraint system malfunctioning

If the restraint system is malfunctioning, restraint system components may be triggered unintentionally or may not deploy as intended during an accident. This may affect the Emergency Tensioning Device or airbag, for example. Furthermore, in the event of an accident, the high-voltage on-board electrical system may not be deactivated as intended.

You may be electrocuted if you touch the damaged component parts of the high-voltage on-board electrical system.

- ▶ Have the restraint system checked and repaired immediately at a qualified specialist workshop.
- ▶ After an accident, switch off the ignition immediately.

- ▶ Drive on carefully.
- ▶ Observe the messages on the multifunction display.
- ▶ Visit a qualified specialist workshop immediately.

<b>A</b>	
<b>Air conditioning system</b>	
see Climate control	
<b>Air distribution</b>	
Setting (control panel) .....	10
<b>Airflow</b>	
Setting (control panel) .....	10
<b>Authorized workshop</b>	
see Qualified specialist workshop	
<b>B</b>	
<b>Battery</b>	
see High-voltage battery	
<b>Battery (high-voltage on-board electrical system)</b>	
see High-voltage battery	
<b>Battery charged</b>	
see Plug-in hybrid operation	
<b>Blower</b>	
see Climate control	
<b>C</b>	
<b>Charging</b> .....	29
Charging cable control panel, version 1 .....	27
Charging station (mode 3) .....	30
Checking the charge level .....	25
Ending the charging process .....	33
Indicator lamp on the vehicle socket .....	25
Mains socket (mode 2) .....	26
Notes on high-voltage battery .....	25
Setting the maximum possible charging current .....	29
Starting the charging process .....	31
Wallbox (mode 3) .....	30
<b>Charging</b>	
see Vehicle socket	
<b>Charging cable control panel, version 1</b>	
Function/notes .....	27
<b>Charging the high-voltage battery</b>	
Charging station (mode 3) .....	30
Mains socket (mode 2) .....	26
Starting the charging process .....	31
Wallbox (mode 3) .....	30

<b>Climate control</b> .....	10
Defrosting the windshield .....	10
Filling capacity for PAG oil .....	41
Immediate pre-entry climate control .....	13
Overview of systems .....	10
Pre-entry climate control at departure time .....	12
Pre-entry climate control via Smart-Key .....	11
Refrigerant filling capacity .....	41
Setting the air distribution (control panel) .....	10
Setting the airflow (control panel) .....	10
Setting the temperature (control panel) .....	10
Switching the rear window defroster on/off .....	10









<b>Coolant (engine)</b>	
Filling capacity .....	41









<b>Cooling</b>	
see Climate control	

**D**

<b>Detaching the charging cable</b>	
see Plug-in hybrid operation	

**Display messages**

 Acoustic Presence Indicator Inoperative .....	47
Change the current drive program before changing the operating mode. (Example) .....	45
 Charger Cable Connected .....	45
E-MODE Currently Unavailable .....	46
Engine will not restart Service required .....	46
 Inoperative Charge HV Battery .....	49
 Inoperative High-Voltage Battery Charging Not Complete .....	50
 Malfunction Service Required .....	47
 Malfunction .....	47
Only E-MODE Available Power Limited Refuel Immediately .....	48
 Please Wait Depressurizing Tank ...	46
 Pre-entry Climate Control via Key Available Again After Engine Start ..	49

 Pre-entry Climate Control via Key Inoperative High-voltage Battery Low .....	49
 See Operator's Manual .....	44
 SRS Malfunction Service Required .....	43
 Stop Vehicle Leave Engine Running .....	45
 Stop Vehicle Shift to 'P' Leave Engine Running .....	48
 Tank is Depressurized Ready for Refueling .....	45
 Tank Ventilation Malfunction Service Required .....	48
 Towing Not Permitted See Operator's Manual .....	46

**Drive programs**

see DYNAMIC SELECT switch

**DYNAMIC SELECT**

Configuring drive program I .....	22
-----------------------------------	----

<b>DYNAMIC SELECT switch</b> .....	20
Operating .....	20

**E****ECO Assist**

Displaying .....	35
Function/notes .....	34

**ECO Assist**

see Haptic accelerator pedal

**ECO start/stop function (electrical driving)**

Operating modes .....	15
-----------------------	----

**Emergency shutoff**

see Hybrid drive system

**Energy flow display**

Displaying .....	19
Function/notes .....	19

**Engine**

Engine number .....	39
---------------------	----

<b>Engine number</b> .....	39
----------------------------	----

**Engine oil**

Capacity .....	40
MB-Freigabe or MB-Approval .....	40



- Quality ..... 40
- F**
- Fuel**
- Fuel reserve ..... 40
- Refueling ..... 35
- Tank content ..... 40
- G**
- Gliding (drive program E)**
- DYNAMIC SELECT switch ..... 20
- H**
- Haptic accelerator pedal** ..... 22
- Function/notes ..... 22
- Heating**
- see Climate control
- High-voltage battery** ..... 25, 42
- Charging time ..... 42
- Function/notes ..... 25
- Model ..... 42
- Range ..... 42
- Setting the maximum possible charging current ..... 29
- High-voltage battery charged**
- Ending the charging process ..... 33
- High-voltage battery charged**
- see Plug-in hybrid operation
- Hybrid drive system** ..... 7
- Configuring settings via the multimedia system ..... 18
- Manual switch-off ..... 7
- I**
- Identification plate**
- Engine ..... 39
- Vehicle ..... 39
- Immediate pre-entry climate control** ..... 13
- Individual drive program**
- Configuring ..... 22
- Instrument cluster**
- see Instrument Display
- Instrument Display** ..... 20
- Function/notes ..... 20
- Overview ..... 20
- Intelligent operating-mode strategy**
- see Route-based operating-mode strategy
- L**
- Limited Warranty**
- Vehicle ..... 5
- M**
- Malfunction**
- Restraint system ..... 9
- Mercedes-Benz Center**
- see Qualified specialist workshop
- Model series** ..... 39
- O**
- Operating mode**
- Replacing ..... 17
- Operating modes**
- Plug-in hybrid operation ..... 15
- Operating safety**
- Information ..... 4
- Operator's Manual**
- Vehicle equipment ..... 4
- Output**
- see Power meter

<b>P</b>	
<b>Paint code</b> .....	39
<b>Permitted towing methods</b> .....	37
<b>Plug-in hybrid operation</b> .....	33
Activating route-based operating-mode strategy (ROS) .....	24
Available operating modes .....	15
Charging cable control panel, version 1 .....	27
Charging the high-voltage battery at a charging station (mode 3) .....	30
Charging the high-voltage battery at a wallbox (mode 3) .....	30
Charging the high-voltage battery at the mains socket (mode 2) .....	26
Checking the charge level .....	25
Configuring settings via the multimedia system .....	18
Displaying ECO Assist .....	35
Displaying the power meter .....	23
DYNAMIC SELECT switch .....	20
Ending the charging process .....	33
Energy flow display .....	19
Haptic accelerator pedal .....	22

Indicator lamp on the vehicle socket .....	25
Manual switch-off of the hybrid system ...	7
Notes on high-voltage battery .....	25
Notes on plug-in hybrid operation .....	6
Power display .....	23
Power meter .....	23
Route-based operating-mode strategy ...	23
Setting the maximum possible charging current .....	29
Showing the energy flow display .....	19
Starting the charging process .....	31
Switching operating mode .....	17
<b>Power display</b> .....	23
Function/notes .....	23
<b>Power meter</b> .....	23
Function/notes .....	23
<b>Pre-entry climate control (immediate)</b> ....	13
<b>Pre-entry climate control at departure time</b> .....	12
Function .....	12
Setting .....	12
Switching on/off .....	13

<b>Pre-entry climate control via Smart-Key</b> .....	11
Function .....	11
Setting .....	11
Switching on/off .....	11

<b>Protecting the environment</b> .....	4
Notes .....	4

<b>Q</b>	
<b>Qualified specialist workshop</b> .....	5

<b>R</b>	
<b>Rapid charging</b> .....	see Charging
<b>Rear window defroster</b> .....	10
<b>Refueling</b> .....	35
Refueling the vehicle .....	35
<b>Reserve</b> .....	40
Fuel .....	40
<b>Restraint system</b> .....	9
Malfunction .....	9
<b>Roof load</b> .....	42

<b>Route-based operating-mode strategy</b> ....	23
Activating .....	24
Function/notes .....	23

## S

<b>Service center</b>	
see Qualified specialist workshop	
<b>Starting assistance</b> .....	37

## T

<b>Tank content</b>	
Fuel .....	40
Reserve (fuel) .....	40
<b>Technical data</b>	
Vehicle identification plate .....	39
<b>Temperature</b>	
Setting (control panel) .....	10
<b>Tire inflation compressor</b>	
see TIREFIT kit	
<b>TIREFIT kit</b> .....	37
Storage location .....	37
<b>Tool</b>	
see Vehicle tool kit	



<b>Towing methods</b> .....	37
<b>Trunk lid</b>	
Opening dimensions .....	41

## V

<b>Vehicle</b>	
Correct use .....	5
Equipment .....	4
Limited Warranty .....	5
Qualified specialist workshop .....	5
<b>Vehicle data</b>	
Roof load .....	42
Turning radius .....	41
Vehicle height .....	41
Vehicle length .....	41
Vehicle width .....	41
Wheelbase .....	41
<b>Vehicle dimensions</b> .....	41
<b>Vehicle identification number</b>	
see VIN	
<b>Vehicle identification plate</b>	
Paint code .....	39
VIN .....	39

<b>Vehicle identification plate</b>	
see Model series	
<b>Vehicle socket</b> .....	25
Indicator lamp .....	25
<b>Vehicle tool kit</b> .....	37
TIREFIT kit .....	37
<b>Ventilation</b>	
see Climate control	
<b>VIN</b> .....	39
Identification plate .....	39
Seat .....	39
Windshield .....	39

## W

<b>Warning/indicator lamp</b>	
 RBS warning lamp (USA/CND) .....	51
 Restraint system warning lamp .....	52
<b>Warranty</b> .....	5
<b>Windshield</b> .....	10
Defrosting .....	10
<b>Windshield</b>	
see Windshield	

**Workshop**

see Qualified specialist workshop



