



2135846017

Order no. P213 1477 13 Part no. 213 584 60 17
Edition A-2021



E-Class Wagon
Mercedes-AMG Supplement

Mercedes-Benz



Publication details

Internet

Further information about Mercedes-Benz vehicles and about Mercedes-Benz AG can be found on the following websites:

<https://www.mbusa.com> (USA only)

<https://www.mercedes-benz.ca> (Canada only)

Documentation team

©Mercedes-Benz AG: Not to be reprinted, translated or otherwise reproduced, in whole or in part, without written permission from Mercedes-Benz AG.

Vehicle manufacturer

Mercedes-Benz AG

Mercedesstraße 120

70372 Stuttgart

Germany

As at 24.09.2019

Thank you for purchasing a Mercedes-AMG

Before you first drive off, read this Operator's Manual carefully and familiarize yourself with your vehicle. For your own safety and a longer operating lifespan of the vehicle, follow the instructions and warning notices in this Operator's Manual. Disregarding them may lead to damage to the vehicle or injury to people.

Damage to the vehicle resulting from the disregard of the instructions is not covered by the Mercedes-Benz Limited Warranty.

The standard equipment and product description of your vehicle may vary and depends on the following factors:

- Model
- Order
- National version
- Availability

Mercedes-AMG reserves the right to introduce changes in the following areas:

- Design
- Equipment

- Technical features

The equipment in your vehicle may therefore differ from that shown in the descriptions and illustrations.

The following documents are integral parts of the vehicle:

- Digital Operator's Manual
- Printed Operator's Manual
- Maintenance Booklet
- Equipment-dependent Supplements

Keep these documents in the vehicle at all times. If you sell the vehicle, always pass all of the documents on to the new owner.

Mercedes-Benz USA, LLC
Mercedes-Benz Canada, Inc.
A Daimler Company

2135846017



Symbols	3	Function of the AMG steering-wheel buttons	25	Technical data	41
At a glance	4	Instrument Display and on-board computer	26	Operating fluids	41
Cockpit	4	Notes on the Instrument Display and on-board computer	26	Vehicle data	43
General notes	7	Operating the on-board computer	26	Display messages and warning/indicator lamps	45
Operator's Manual	7	Calling up displays on the Performance menu	28	Display messages	45
Operating safety	7	Function of the Head-up Display	30	Warning and indicator lamps	46
Qualified specialist workshop	8	MBUX multimedia system	32	Index	49
Correct use of the vehicle	8	AMG TRACK PACE	32		
Limited Warranty	9	Breakdown assistance	38		
Occupant safety	10	Flat tire	38		
Seat belts	10	Wheels and tires	39		
Airbags	10	Overview of the tire-change tool kit	39		
Driving and parking	11	Changing a wheel	39		
Driving	11				
DYNAMIC SELECT switch	13				
Automatic transmission	14				
Driving and driving safety systems	16				

In this Operator's Manual, you will find the following symbols:

⚠ DANGER Danger due to not observing the warning notices

Warning notices draw your attention to hazards that may endanger your health or life, or the health or life of others.

▶ Observe the warning notices.

🌿 ENVIRONMENTAL NOTE Environmental damage due to failure to observe environmental notes

Environmental notes include information on environmentally responsible behavior or environmentally responsible disposal.

▶ Observe environmental notes.

! NOTE Damage to property due to failure to observe notes on material damage

Notes on material damage inform you of risks which may lead to your vehicle being damaged.

▶ Observe notes on material damage.

ⓘ These symbols indicate useful instructions or further information that could be helpful to you.

▶ Instruction

(→ page) Further information on a topic

Display Information on the multifunction display/media display

↪ Highest menu level, which is to be selected in the multimedia system

➡➡ Relevant submenus, which are to be selected in the multimedia system

* Indicates a cause

4 At a glance – Cockpit

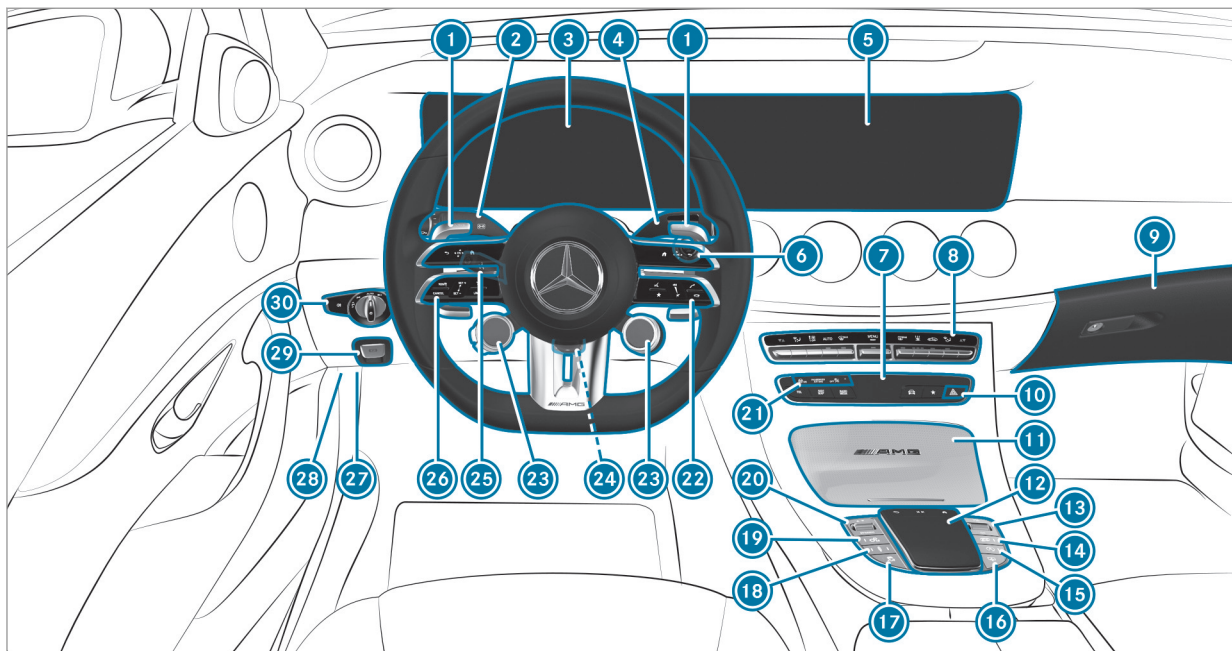

Left-hand-drive vehicles

①	Steering wheel gearshift paddles	→	15	⑮	ECO start/stop function	→	12
②	Combination switch			⑯	Active Parking Assist		
③	Instrument Display	→	26	⑰	ESP®	→	16
④	DIRECT SELECT lever			⑱	AMG adaptive sport suspension system +	→	22
⑤	Media display			⑲	Manual gearshifting	→	15
⑥	Start/stop button	→	11	⑳	DYNAMIC SELECT switch	→	13
⑦	Calls up MBUX multimedia system applications			㉑	PASSENGER AIR BAG indicator lamps		
⑧	Climate control systems			㉒	Control panel for the MBUX multimedia system		
⑨	Glove box			㉓	AMG steering-wheel buttons	→	25
⑩	Hazard warning light system			㉔	Adjusts the steering wheel mechanically		
⑪	Stowage compartment			㉕	Adjusts the steering wheel electrically		
⑫	Touchpad				Switches the steering wheel heater on/off		
⑬	Controller for volume and switching sound on/off			㉖	Control panel:		
	Switches the MBUX multimedia system on/off				On-board computer	→	26
⑭	AMG Performance exhaust system	→	13		Cruise control		
					Active Distance Assist DISTRONIC		

6 At a glance – Cockpit

27 Diagnostics connection

28 Opens the hood

29 Electric parking brake

30 Light switch

Operator's Manual

This Supplement provides information on all the important functions of your AMG vehicle that are either not described or differ from the descriptions in the vehicle Operator's Manual. This information supplements or replaces the corresponding sections in the vehicle Operator's Manual. Under no circumstances does the Supplement replace the Operator's Manual.

This Supplement describes all models, and standard and optional equipment for your vehicle, as available at the time of going to press. Country-specific differences are possible. Bear in mind that your vehicle may not feature all functions described here. This is also the case for systems and functions relevant to safety. Therefore, the equipment on your vehicle may differ from that in the descriptions and illustrations.

The original purchase contract documentation for your vehicle contains a list of all of the systems in your vehicle.

Should you have any questions concerning equipment and operation, please consult an authorized Mercedes-Benz Center.

The Operator's Manual, the Supplement and the Maintenance Booklet are important documents and should be kept in the vehicle.

Operating safety

▲ WARNING Risk of accident due to malfunctions or system failures

To avoid malfunctions or system failures:

- ▶ Always have the prescribed service and maintenance work as well any required repairs carried out at a qualified specialist workshop.

▲ WARNING Risk of accident or injury due to incorrect modifications on electronic component parts

Modification of electronic components, their software or wiring could impair their function

and/or the function of other networked component parts or safety-relevant systems.

This can endanger the operating safety of the vehicle.

- ▶ Never tamper with the wiring and electronic component parts or their software.
- ▶ You should have all work on electrical and electronic components carried out at a qualified specialist workshop.

Observe the "On-board electronics" section in "Technical data" in the vehicle Operator's Manual.

▲ WARNING Risk of fire due to flammable materials on hot parts of the exhaust system

Flammable material such as leaves, grass or twigs may ignite if they come into contact with hot parts of the exhaust system.

- ▶ When driving on unpaved roads or off-road, regularly check the vehicle underside.
- ▶ Remove trapped plants or other flammable material, in particular.
- ▶ If there is damage, consult a qualified specialist workshop immediately.

! **NOTE** Damage to the vehicle

In the following situations, in particular, there is a risk of damage to the vehicle:

- The vehicle becomes grounded, e.g. on a high curb or an unpaved road
- The vehicle is driven too fast over an obstacle, e.g. a curb, speed bump or pothole
- A heavy object strikes the underbody or chassis components

In situations such as this, the body, the underbody, chassis components, wheels or tires could be damaged without the damage being visible. Components damaged in this

way can unexpectedly fail or, in the case of an accident, may not absorb the loads that arise as intended.

If the underbody paneling is damaged, flammable materials such as leaves, grass or twigs can collect between the underbody and the underbody paneling. These materials may ignite if they come into contact with hot parts on the exhaust system.

- ▶ Have the vehicle checked and repaired immediately at a qualified specialist workshop.

or

- ▶ If driving safety is impaired while continuing your journey, pull over and stop the vehicle immediately in accordance with the traffic conditions, and contact a qualified specialist workshop.

Qualified specialist workshop

An authorized Mercedes-Benz Center is a qualified specialist workshop. It has the necessary special skills, tools and qualifications to cor-

rectly carry out the work required on your vehicle. This particularly applies to safety-relevant works.

Always have the following work carried out on your vehicle at a qualified specialist workshop:

- safety-relevant works
- service and maintenance work
- repair work
- modifications as well as installations and conversions
- work on electronic components

Mercedes-AMG recommends a Mercedes-Benz service center.

Correct use of the vehicle

If you remove any warning stickers, you or others could fail to recognize certain dangers. Leave warning stickers in position.

Observe the following information in particular when driving your vehicle:

- the safety notes in this manual

- technical data for the vehicle
- traffic rules and regulations
- laws and safety standards pertaining to motor vehicles

Limited Warranty

! **NOTE** Damage to the vehicle arising from violation of these operating instructions.

Damage to the vehicle can arise from violation of these operating instructions.

This damage is not covered either by the Mercedes-Benz implied warranty or by the New- or Used-Vehicle Warranty.

- ▶ Follow the instructions in these operating instructions on proper operation of your vehicle as well as on possible vehicle damage.

Seat belts

Reduced protection

The AMG sport seat and the AMG Performance seat are designed for the standard three-point seat belt. If you install a different multipoint seat belt, e.g. sport or racing seat belts, the restraint system cannot provide the intended level of protection.

Depending on the type of seat, there may be openings in the seat backrest. These openings have no function.

⚠ WARNING Risk of injury or fatal injury due to modified seat belt systems

If you feed seat belts through the opening in the seat backrest, the seat backrest may be damaged or may even break in the event of an accident.

- ▶ Only use the standard three-point seat belt.
- ▶ Never modify the seat belt system.

Airbags

Protection provided by the side airbag

Vehicles with AMG Performance seat: depending on the accident situation, the side airbag can increase the level of protection for the ribcage of the respective passenger in addition to a correctly fastened seat belt.

Driving

Breaking-in notes

To preserve the engine during the first 1,000 miles (1,500 km):

- drive at varying road speeds and engine speeds.
- do not drive faster than 85 mph (140 km/h).
- allow the engine to reach a maximum engine speed of 4,500 rpm (4,500 rpm) only briefly.
- drive the vehicle in drive program **C**.
- change gear before the tachometer needle is $\frac{2}{3}$ of the way to the red area of the tachometer.
- do not shift down a gear manually in order to brake.
- avoid overstraining the vehicle, e.g. driving at full throttle.
- do not depress the accelerator pedal past the pressure point (kickdown).
- only increase the engine speed gradually and accelerate the vehicle to full speed after 1,000 miles (1,500 km).

This also applies when the engine or parts of the drivetrain have been replaced.

Please also observe the following breaking-in notes:

- In certain driving and driving safety systems, the sensors adjust automatically while a certain distance is being driven after the vehicle has been delivered or after repairs. Full system effectiveness is not reached until the end of this teach-in process.
- Brakepads, brake discs and tires that are either new or have been replaced only achieve optimum braking effect and grip after several hundred kilometers of driving. Compensate for the reduced braking effect by applying greater force to the brake pedal.

Function of Emotion Start

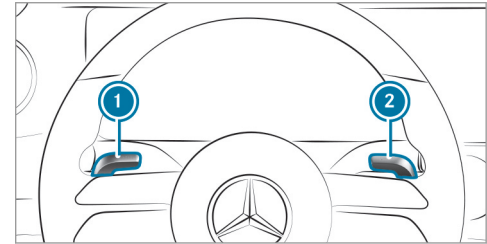

- ▶ Start the vehicle with the start/stop button and simultaneously pull one of the steering wheel gearshift paddles ① or ②.
 - The idle speed is increased briefly when starting the engine.
 - The exhaust gas flaps are opened (sporty characteristic) (→ page 12).

Observe the notes on starting the vehicle in the vehicle Operator's Manual.

Notes on the locking differential

After a breaking-in period of 2000 miles (3000 km) the oil on the locking differential should be changed in a qualified specialist workshop. This oil change prolongs the service life of the locking differential.

Be sure to observe the information sticker regarding the breaking-in notes on the windshield.

Operation of the ECO start/stop function

The engine is automatically switched off if the following conditions are met:

- if all vehicle conditions for an automatic engine stop are met.
- you brake the vehicle to a standstill in transmission position **D** or **N**.
- you depress the brake pedal when driving at speeds below 15 mph (20 km/h).

The engine is restarted automatically if:

- you release the brake pedal in transmission position **D** when the HOLD function is not active.
- you shift from transmission position **P**.
- you engage transmission position **D** or **R**.
- you depress the accelerator pedal.
- you permanently activate manual gearshifting.
- you pull the left-hand steering wheel gearshift paddle.
- an automatic engine start is required by the vehicle.

If the engine was switched off by the ECO start/stop function and you leave the vehicle, a warning tone sounds and the engine is not restarted. In addition, the [Vehicle Ready to Drive Switch the Ignition Off Before Exiting](#) message appears in the multifunction display. If you do not switch off the ignition, the ignition is automatically switched off after one minute.

AMG Performance exhaust system

Function of the AMG Performance exhaust system

Changing the position of the exhaust gas flaps allows you to select the sound characteristics of the AMG Performance exhaust system:

- Closed exhaust gas flaps: comfort characteristic (balanced)
- Open exhaust gas flaps: sporty characteristic (powerful)

Operating the AMG Performance exhaust system

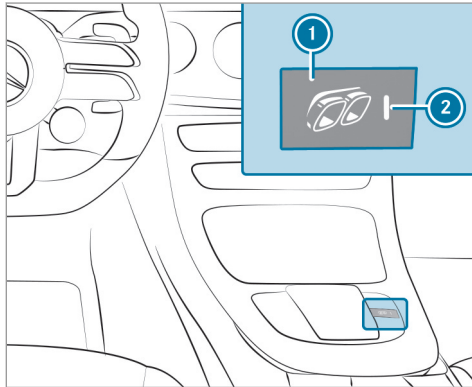

- ▶ Press button ①.
The sporty characteristic (powerful) is selected when indicator lamp ② lights up.

Information on the AMG ceramic high-performance composite brake system

The brake system is designed for heavy loads. This may lead to noise when braking. This effect can also occur after washing the vehicle.

The noise depends on the following factors:





- Speed
 - Brake force
 - Environmental conditions, e.g. temperature and air humidity
- ① Have the brake system checked at a qualified specialist workshop after it has been subjected to extreme loads.

DYNAMIC SELECT switch



Function of the DYNAMIC SELECT switch

Use the DYNAMIC SELECT switch to change between the following drive programs:

-  (**Slippery**): optimized pulling away and driving characteristics in wintry and slippery road conditions

-  (**Individual**): individual settings
-  (**Comfort**): comfortable and economical driving style
-  (**Sport**): sporty driving style
-  (**Sport Plus**): particularly sporty driving style
-  (**RACE**): driving like on a race track

- ① The drive program  (**RACE**) is available only for the **Mercedes-AMG E 63 S 4MATIC +** model or for vehicles with **AMG DYNAMIC PLUS** package.



The  (**RACE**) drive program may not be used on normal roads.  (**RACE**) must only be activated and used on dedicated race circuits, not on public roads.

Mercedes-AMG recommends selecting the drive program  (**C**) when in city traffic or stop-and-go traffic.

Depending on the drive program selected, the following vehicle characteristics will change:

- Drive
 - Engine and transmission management

14 Driving and parking

- Active Distance Assist DISTRONIC
- AMG Dynamics
 - The four agility functions Basic, Advanced, Pro and Master are automatically selected depending on the drive program.
 - The steering, shift timing point, all-wheel drive and stabilization functions are adapted to the selected drive program.
 - When ESP® is activated, agility function Pro is selected in drive program  RACE. The Master function is automatically selected when ESP® is deactivated.
- Position of the exhaust gas flaps
- Suspension
- Steering
- Availability of glide mode
- The  (RACE) drive program has the following properties:
 - The vehicle exhibits driving characteristics suited for the racetrack.
 - All vehicle systems are set for maximum sportiness.
 - The automatic transmission shifts up later.
 - The suspension exhibits particularly firm springing and damping settings.
 - Glide mode is not available.
 - The sporty sound characteristic of the exhaust system is activated.

- ① You can call up vehicle characteristics via the Performance menu in the on-board computer (→ page 28).
- ① You can adjust the agility functions of AMG Dynamics using the AMG steering-wheel buttons.

You can also change the following vehicle characteristics using the buttons in the center console:

- Position of the exhaust gas flaps
- Suspension

Automatic transmission

Rocking the vehicle free

Rocking the vehicle free can help to free a vehicle that has become trapped in slush or snow.

To rock the vehicle free, move the DIRECT SELECT lever upwards and downwards past the point of resistance in order to switch between transmission positions **D** and **R**.

- ① The maximum design speed when switching between **D** and **R** is 6 mph (9 km/h).

Manual gearshifting

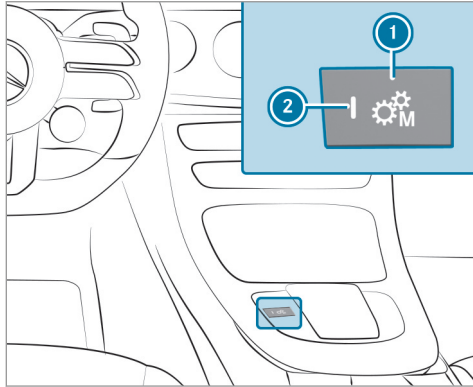

- ▶ **To activate/deactivate:** press button ①. If indicator lamp ② is lit, manual gearshifting is activated. The current gear is displayed in the multifunction display.

① To permanently shift the gears manually in drive program **I+** using the steering wheel

gearshift paddles, select the **M** (Manual) setting for the transmission.

! **NOTE** Damage to the engine due to shifting up too late

The automatic transmission does not shift up in manual mode even when the engine's limiting speed is reached.

The fuel supply is interrupted in order to prevent the engine from overrevving.

- ▶ Shift up before the engine speed reaches the red area in the tachometer.

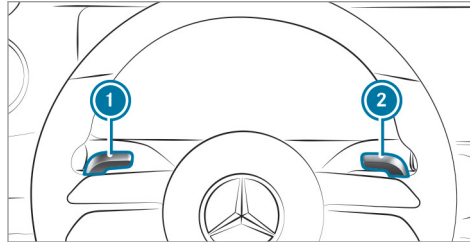

- ▶ **To shift up:** pull steering wheel gearshift paddle ②.
- ▶ **To shift down:** pull steering wheel gearshift paddle ①.

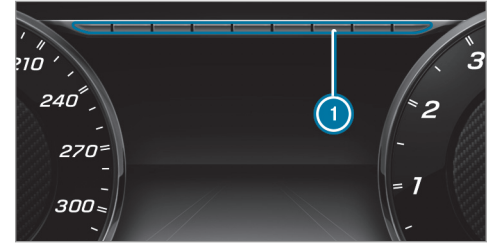

If the engine speed is too high or too low, you cannot change gear using the steering wheel gearshift paddles. In this case, segments ① light up red.

Gearshift recommendation

The gearshift recommendation assists you in adopting an economical driving style.

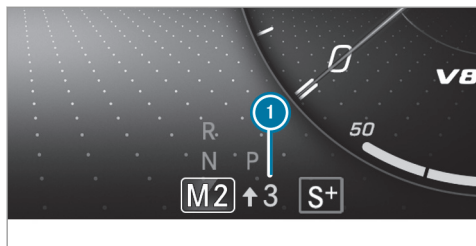

- ▶ If gearshift recommendation message ① appears on the multifunction display, shift to the recommended gear.

Using kickdown

- ▶ **Maximum acceleration:** depress the accelerator pedal beyond the pressure point.

The automatic transmission shifts up to the next gear when the maximum engine speed is reached to protect the engine from overrevving.

- ① If you have activated manual gearshifting with the button in the center console, the

transmission does not react to the kick-down.

Glide mode function

With an anticipatory driving style, glide mode helps you to reduce fuel consumption.

Glide mode is characterized by the following:

- the combustion engine is disconnected from the drivetrain and the vehicle continues to roll.
- **Mercedes-AMG E 53 4MATIC+:** the combustion engine is switched off. All of the vehicle functions remain active.
- the  symbol appears in the multifunction display.

Glide mode is activated if the following conditions are met:

- the ECO start/stop function is switched on.
- drive program  is selected with the drive setting "Moderate" or "Reduced".
- the speed is within a suitable range.

- the road's course is suitable, e.g. no steep uphill or downhill inclines or tight bends.
- **Mercedes-AMG E 53 4MATIC+:** The charge level of the battery is sufficient.
- you are no longer depressing the accelerator or brake pedal.

Glide mode is deactivated again if one of the conditions is no longer met.

Driving and driving safety systems

Functions of ESP® (Electronic Stability Program)

 **WARNING** Risk of skidding if ESP® is malfunctioning

If ESP® is malfunctioning, ESP® cannot carry out vehicle stabilization. In addition, other driving safety systems are switched off.

- ▶ Drive on carefully.
- ▶ Have ESP® checked at a qualified specialist workshop.

You can select between the following modes of ESP®:

- ESP® ON
- ESP® SPORT
- ESP® OFF

Characteristics when ESP® is activated

ESP® monitors and improves driving stability and traction, particularly in the following situations:

- When pulling away on a wet or slippery road.
- When braking.
- In strong side winds when you are driving faster than 47 mph (75 km/h).

ESP® can stabilize the vehicle by intervening in the following ways:

- One or more wheels are braked.
- The engine output is adapted according to the situation.

ESP® is activated every time the engine is started regardless of whether ESP® was in ESP®

SPORT or deactivated before the engine was switched off.

If the  ESP® warning lamp flashes in the instrument cluster, one or several vehicle wheels has reached its grip limit:



- Adapt the driving style to suit the prevailing road and weather conditions.
- Do not deactivate ESP® under any circumstances.
- Only depress the accelerator pedal as far as is necessary.

Characteristics of ESP® SPORT

⚠ WARNING Risk of skidding if ESP® SPORT is used incorrectly

When you activate ESP® SPORT, there is an increased risk of skidding and having an accident.

- ▶ Activate ESP® SPORT only in the circumstances described below.

When ESP® SPORT is activated, the  and  warning lamps light up continuously in the instrument cluster.

Select ESP® SPORT when the vehicle's own oversteering and understeering characteristics are desired, e.g. on designated roads.

Driving with ESP® SPORT or with ESP® deactivated requires an extremely qualified and experienced driver.

If ESP® SPORT is activated and one or more wheels start to spin, the  ESP® warning lamp on the instrument cluster flashes. ESP® then only stabilizes the vehicle to a limited degree.

ESP® SPORT also has the following characteristics:

- ESP® only improves driving stability to a limited degree.
- ETS/4ETS traction control is still active.
- The engine's torque is only restricted to a limited degree and the drive wheels can spin.

18 Driving and parking

The spinning of the wheels results in a cutting action for better traction on loose surfaces.



- ESP® continues to provide assistance when the brakes are firmly applied.
- Crosswind Assist is no longer active.

Characteristics when ESP® is deactivated

⚠ WARNING Risk of skidding if ESP® is deactivated

If you deactivate ESP®, ESP® cannot carry out vehicle stabilization.

- ▶ ESP® should only be deactivated in the following situations.

When ESP® is deactivated, the  and  warning lamps light up continuously in the instrument cluster.

Deactivating ESP® has the following effects:

- Driving stability will no longer be improved.
- The drive wheels could spin.
- ETS/4ETS traction control is still active.

- Crosswind Assist is no longer active.

i Even when ESP® is deactivated, you are still assisted by ESP® when braking hard.

It may be best to activate ESP® SPORT or deactivate ESP® in the following situations:

- When using snow chains.
- In deep snow.
- On sand or gravel.

i Spinning the wheels results in a cutting action, which enhances traction.

i Activate ESP® as soon as the situations described above no longer apply. ESP® will otherwise not be able to stabilize the vehicle if the vehicle starts to skid or a wheel starts to spin.

If the  ESP® warning lamp lights up continuously even when ESP® is activated, ESP® is not available due to a malfunction.

Observe any information which may be displayed in the instrument cluster:

- Indicator and warning lamps

- Display messages

ETS/4ETS (Electronic Traction System)

ETS/4ETS traction control is part of ESP®.

ETS/4ETS can improve the vehicle's traction by intervening in the following ways:

- The drive wheels are braked individually if they spin.
- More drive torque is transferred to the wheel or wheels with traction.

Activating/deactivating ESP® (Electronic Stability Program)

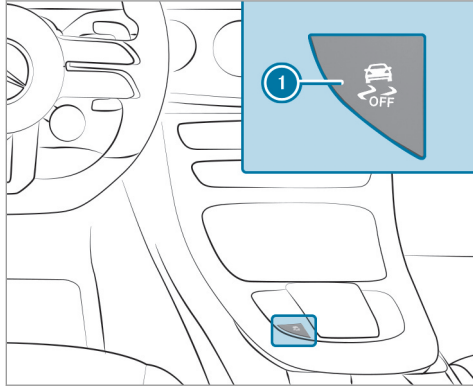

- ▶ **To activate ESP® SPORT:** briefly press button ①. The  and  warning lamps appear in the instrument cluster.

- ▶ **To deactivate ESP®:** press and hold button ① until the  and  warning lamps appear in the instrument cluster.

- ① When you deactivate ESP® in the  drive program, AMG Dynamics automatically switches to the **Master** level.

- ▶ **To activate ESP®:** briefly press button ①. The ,  and  warning lamps go out.

Observe the information on warning lamps and display messages which may be shown in the instrument cluster.

RACE START

Function of RACE START

- ① RACE START is only available for **Mercedes-AMG E 63 4MATIC+ and E 63 S 4MATIC+** models.

RACE START enables optimal vehicle acceleration from a standstill. For this, a suitably high-grip road surface is required, the tires and vehicle must also be in good condition.

- ① RACE START is only available after the vehicle has been broken in (→ page 11).
- ① RACE START may not be used on normal roads. RACE START must only be activated and used on dedicated race circuits, not on public roads. Be sure to read the safety notes and information on ESP® (→ page 16).

⚠ WARNING Risk of skidding and having an accident from wheels spinning

If you use RACE START, depending on the ESP® mode selected, there is an increased risk of skidding and having an accident.

- ▶ Make sure that no persons or obstacles are in the close vicinity of your vehicle.

Activating RACE START Requirements:

- the driver's door is closed.
- the engine is running and the transmission and engine are at normal operating temperature.

- the front wheel is in the straight-ahead position.
 - the vehicle is on level ground.
 - the vehicle is stationary, the brake pedal is depressed (left foot) and the parking brake is released.
 - the transmission is in position **D**.
 - the DRIFT MODE is deactivated.
 - one of the drive programs **S**, **S⁺** or **ESP** is selected (→ page 13).
- ▶ Rapidly depress the accelerator pedal fully. The engine speed increases.
- ❗ If the activation conditions are not fulfilled, RACE START cannot be activated. The **RACE START Not Possible See Operator's Manual** message appears in the multifunction display.
- ▶ The **RACE START Release brake to start** message appears in the multifunction display.
- ❗ In this phase you can adjust RACE START depending on the road conditions: you can vary the engine speed by pulling on one of

the steering wheel gearshift paddles. The segments in the multifunction display flicker rapidly.

- ❗ If the brake pedal is not released after a short while, RACE START is canceled. The **RACE START Canceled** message appears in the multifunction display.
- ▶ Take your foot off the brake, but keep the accelerator pedal depressed. The vehicle pulls away at maximum acceleration. The **RACE START Active** message appears in the multifunction display.

RACE START is deactivated immediately if you release the accelerator pedal during RACE START or if any of the activation conditions are no longer fulfilled. The **RACE START Canceled** message appears in the multifunction display.

- ❗ After using it several times in short succession, RACE START is unavailable until a certain distance has been driven.

DRIFT MODE

Functions of DRIFT MODE

- ❗ DRIFT MODE is available only for the **Mercedes-AMG E 63 S 4MATIC+** model or for vehicles with **AMG DYNAMIC PLUS package**.

DRIFT MODE enables intentional unstable movement (drifting) and oversteering of the vehicle. All activation conditions must be fulfilled for this (ESP® deactivated, for example).

- ❗ Only a highly qualified and experienced driver should drive in DRIFT MODE. Be sure to read the safety notes and information on ESP® (→ page 16).

⚠ WARNING Risk of skidding and having an accident from wheels spinning

When you use DRIFT MODE, ESP® is not available.

There is an increased risk of skidding and having an accident.

- ▶ Do not use DRIFT MODE on normal roads.
- ▶ DRIFT MODE may only be activated and used on closed race circuits, not on public roads.
- ▶ Make sure that no persons or obstacles are in the close vicinity of your vehicle.

When DRIFT MODE is active, the vehicle drive occurs only at the rear and 4MATIC+ is deactivated.

From a speed of approximately 70 mph (115 km/h) up to 95 mph (150 km/h) 4MATIC+ is continuously reactivated. From a speed of 95 mph (150 km/h) 4MATIC+ is fully active again, ESP® however, remains deactivated. Below a speed of 95 mph (150 km/h) to approximately 70 mph (115 km/h) 4MATIC+ is continuously deactivated again.

- ① DRIFT MODE is only available after the vehicle has been broken in (→ page 11).

Activating and deactivating DRIFT MODE Requirements:

- ESP® is deactivated (→ page 19).
- drive program  (RACE) is selected (→ page 13).
- the doors, the hood and the tailgate are closed.
- the engine is running and the transmission and engine are at normal operating temperature.
- the transmission is in manual mode – manual shifting is activated (→ page 15).

Activating DRIFT MODE

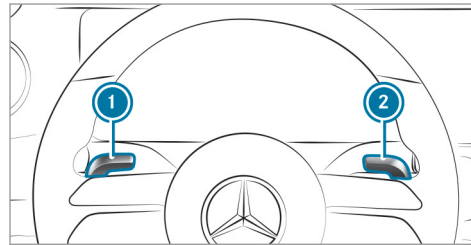

- ▶ Pull steering wheel gearshift paddles ① and ② and hold for half a second. If all activation conditions are fulfilled, the multifunction display shows the **DRIFT MODE Confirm: Paddle UP Cancel: Paddle DOWN** message and the **DRIFT** warning lamp flashes.
- ▶ **To cancel:** pull the steering wheel gearshift paddle ①. The multifunction display shows the **DRIFT MODE Canceled** message and the **DRIFT** warning lamp goes out.
- ▶ **To confirm:** pull the steering wheel gearshift paddle ②. The multifunction display shows the **DRIFT MODE Active** message and the **DRIFT** warning lamp lights up.

Deactivating DRIFT MODE

- ▶ Pull steering wheel gearshift paddles ① and ② and hold for half a second. The **DRIFT MODE Active** message and the **DRIFT** warning lamp go out.

22 Driving and parking

DRIFT MODE is automatically deactivated in the following situations:

- ESP® is activated.
 - manual shifting is deactivated – the gearbox is in position **D**.
 - the drive program  (**RACE**) is switched off.
 - the vehicle is switched off.
 - automatic switch off is required by the vehicle.
- i** After drifting and before continuing the journey, check the wheels and tires for damage. In particular, check the tire tread depth and tire contact surface over the entire width of the tires (see the vehicle Operator's Manual).

AMG adaptive sport suspension system +

Function of AMG adaptive sport suspension system +

The AMG adaptive sport suspension system + is an air suspension system with variable damping for improved driving characteristics. The all-

round level control system ensures the best possible suspension and constant ground clearance, even with a laden vehicle. When driving at speed, the vehicle is lowered automatically to improve driving safety and to reduce fuel consumption. You also have the option of manually adjusting the vehicle level.

The damping is set individually for each wheel and is affected by the following factors:

- Driving style, e.g. sporty
- Road condition, e.g. bumps
- The individual selection of **Sport**, **Sport +** or **COMFORT**

The AMG adaptive sport suspension system + includes the following components and functions:

- Air suspension with variable spring rate and automatic level control
- Speed-dependent lowering to reduce fuel consumption
- Manually selectable high-level setting for greater ground clearance

- ADS PLUS (Adaptive Damping System with constant damping force adjustment)
- DYNAMIC SELECT switch and level button.
- Suspension setting button

Suspension settings and vehicle level per drive program

Mercedes-AMG E 53 4MATIC+

Drive programs  and **C**:

- The suspension setting is comfortable.
- The vehicle is set to the normal level.
- When driving at speeds of 100 mph (160 km/h) or above, the vehicle is lowered.
- When driving at speeds below 87 mph (140 km/h), the vehicle is raised again.
- 4MATIC+ is dynamically synchronized.

Drive programs **S**, **S+** and 

- The suspension setting is firmer.
- The vehicle is set to the low level.
- The vehicle is not lowered any further if you are traveling at higher speeds.
- 4MATIC+ is more dynamically synchronized.

- ❗ The setting can also be set using the DYNAMIC SELECT switch. To do this, the same suspension setting must be selected for AMG adaptive sport suspension system and the DYNAMIC SELECT switch.
- ❗ When the vehicle is started again, the **COMFORT** setting is activated automatically.

Suspension settings and vehicle level per drive program

Mercedes-AMG E 63 4MATIC+ and Mercedes-AMG E 63 S 4MATIC+

Drive programs , **C** and **S**:

- The suspension setting is comfortable ( and **C**).
- The suspension setting is firmer (**S**).
- The vehicle is set to the normal level.
- When driving at speeds of 130 mph (210 km/h) or above, the vehicle is lowered.
- When driving at speeds below 75 mph (120 km/h) the vehicle is raised again.
- 4MATIC+ is dynamically synchronized.

Drive programs **S** and :

- The suspension setting is even firmer.
 - The vehicle is set to the low level.
 - The vehicle is not lowered any further if you are traveling at higher speeds.
 - 4MATIC+ is more dynamically synchronized.
- ❗ The setting can also be set using the DYNAMIC SELECT switch. To do this, the same suspension setting must be selected for AMG adaptive sport suspension system and the DYNAMIC SELECT switch.
 - ❗ When the vehicle is started again, the **COMFORT** setting is activated automatically.

Selecting the AMG adaptive sport suspension system setting

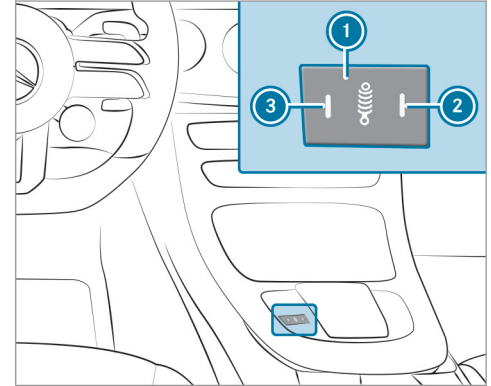

- ▶ **COMFORT suspension setting:** press button 1 repeatedly until indicator lamps 2 and 3 go out. The **AMG Suspension System COMFORT** message appears in the multifunction display.

The driving characteristics of your vehicle are comfortable.

- ▶ **SPORT suspension setting:** press button ① repeatedly until indicator lamp ③ lights up.

The **AMG Suspension System SPORT** message appears in the multifunction display.

The suspension is adapted to be firmer.

- ▶ **SPORT+ suspension setting:** press button ① repeatedly until indicator lamps ② and ③ light up.

The **AMG Suspension System SPORT +** message appears in the multifunction display.

The vehicle is lowered to low level and the suspension is set to very firm.

Setting the vehicle level

- ⚠ **WARNING** Risk of accident because vehicle level is too high

Driving characteristics may be impaired.

The vehicle can drift outwards, for example, when steering or cornering.

- ▶ Choose a vehicle level which is suited to the driving style and the road surface conditions.

- ⚠ **WARNING** Risk of entrapment from vehicle lowering

When lowering the vehicle, people could become trapped if their limbs are between the vehicle body and the tires or underneath the vehicle.

- ▶ Make sure no one is underneath the vehicle or in the immediate vicinity of the wheel arches when the vehicle is being lowered.

- ⚠ **WARNING** Risk of becoming trapped due to the vehicle lowering

Vehicles with AIR BODY CONTROL or level control system: when you unload luggage or leave the vehicle, the vehicle first rises slightly and then returns to the set level shortly afterwards.

You or anyone else in the vicinity of the wheel arches or the underbody could thus become trapped.

The vehicle can also be lowered after being locked.

- ▶ When leaving the vehicle, make sure that nobody is in the vicinity of the wheel arches or the underbody.

Requirements:

- The vehicle has been started.
- The vehicle must not be moving faster than 40 mph (65 km/h).

Multimedia system:

➔  ➔ [Settings](#) ➔ [Quick Access](#)

Raising the vehicle

- ▶ Select .
- The vehicle is raised to the high level.

Your selection is saved.

The vehicle lowers itself back down to the height of the most recently active drive program:

- **Mercedes-AMG E 63 4MATIC+ and E 63 S 4MATIC+:**
 - When driving faster than 75 mph (120 km/h).
 - When driving between 50 mph (80 km/h) and 75 mph (120 km/h) for approximately three minutes.
- **Mercedes-AMG E 53 4MATIC+:**
 - When driving faster than 62 mph (100 km/h).
 - When driving between 50 mph (80 km/h) and 62 mph (100 km/h) for approximately three minutes.
- After selecting a drive program using the DYNAMIC SELECT switch.

Lowering the vehicle

- ▶ Select . The vehicle is adjusted to the height of the last active drive program.

Function of the AMG steering-wheel buttons

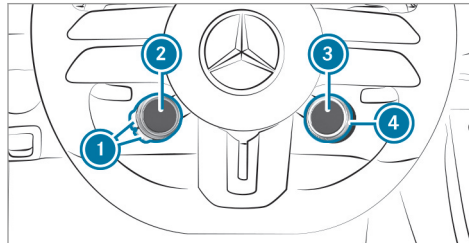

The AMG steering-wheel buttons are two additional control elements on the steering wheel.

You can assign two vehicle functions of your choice to the left control element. You can change between the available functions for corresponding button ① by pressing display button ② on the upper or lower area repeatedly. Display switch ② shows each function selected.

The following functions are available:

- ESP® (→ page 16)

- AMG adaptive sport suspension system + (→ page 22)
- AMG Performance exhaust system (→ page 13)
- ECO start/stop function (→ page 12)
- Manual gearshifting (→ page 15)
- AMG Dynamics (→ page 13)







If you have assigned specific functions to display button ②, you can operate these functions with corresponding button ①.

The assignment of display button ② remains stored even after a new engine start, but the operating status of the respective function is reset to the basic setting.

You can change between the drive programs with stabilizer bar actuator ③. The selected drive program appears in display button ④. By pressing display button ④, you can directly access the drive program  (**Individual**) (→ page 13).

Notes on the Instrument Display and on-board computer

Additional notes regarding your Mercedes-AMG vehicle:

- **Vehicles with an Instrument Display (standard):** if you activate manual gearshifting, (→ page 15) the upshift bar will appear on the multifunction or Head-up Display. In addition, transmission set-up  (manual) and the current gear will appear on the transmission position display of the multifunction display.
- If you switch on the ECO start/stop function and select drive program , the engine electronics will switch from eight-cylinder mode to four-cylinder mode, if necessary. The multifunction display will show the  symbol in the status area.
- Additional note regarding the indicator and warning lamps: the vehicle is also equipped with the ESP[®] , ESP[®] OFF  and ESP[®] SPORT  indicator and warning lamps (→ page 47).

You can select the following display content, for example:

- Tachometer with gear display
- Date and time
- Warm-up
- AMG TRACK PACE
- G-meter
- Engine data
- SETUP
- Trip computer
- Navigation
- Media
- Telephone

AMG TRACK PACE is displayed on the left-hand section of the display. The warm-up, engine data, SETUP and G-meter menus are displayed on the right-hand section of the display.

Operating the on-board computer

 **WARNING** Risk of distraction from information systems and communications equipment

If you operate information and communication equipment integrated in the vehicle when driving, you will be distracted from the traffic situation. This could also cause you to lose control of the vehicle.

- ▶ Only operate this equipment when the traffic situation permits.
- ▶ If you cannot be sure of this, stop the vehicle whilst paying attention to road and traffic conditions and operate the equipment with the vehicle stationary.

Observe the legal requirements for the country in which you are currently driving when operating the on-board computer.

-  The on-board computer displays will appear on the multifunction display.

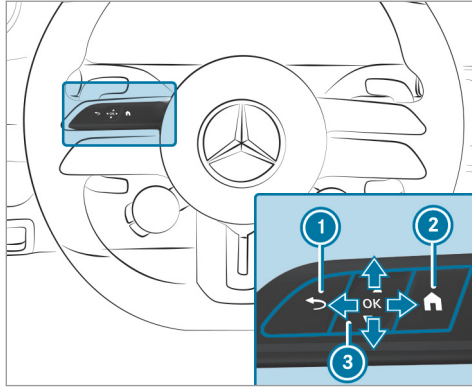

- ① Back button
- ② Main menu
- ③ Touch Control

The on-board computer is operated using left-hand Touch Control ③, back button ① and left-hand home button ②.

When the on-board computer is being operated, different acoustic signals will sound as operating

feedback, e.g. when the end of a list is reached or when you are scrolling through a list.

The following menus are available:

- Assistance
- Phone
- Navigation
- Performance
- Trip
- Radio
- Media
- Designs & Disp.
- Service

The menus can be called up from the menu bar on the multifunction display.

- ▶ **To call up the menu bar:** press the back button on the left ① until the menu bar is displayed.



- ▶ **To scroll in the menu bar:** swipe left or right on left-hand Touch Control ③.
- ▶ **To call up a menu or confirm a selection:** press the left-hand Touch Control ③.
- ▶ **To scroll through displays or lists on the menu:** swipe upwards or downwards on the left-hand Touch Control ③.
- ▶ **To call up a submenu or confirm a selection:** press the left-hand Touch Control ③.
- ▶ **To exit a submenu:** press left-hand back button ①.

Selecting the Head-up Display

▶ **If the Head-up Display is switched off:** switch on the Head-up Display via the multimedia system or activate it in the menu bar by swiping upwards on the left-hand Touch Control ③.

The Head-up Display menu has been selected on the Head-up Display.

▶ **To switch to the Head-up Display:** press left-hand Touch Control ③ or swipe upwards on left-hand Touch Control ③.

▶ **To select what the Head-up Display shows:** swipe upwards or downwards on left-hand Touch Control ③.

Full-screen menus

You can display the following menus in full on the Instrument Display:

- Assistance
- Trip
- Navigation

▶ On the corresponding menu, use left-hand Touch Control ③ to scroll to the end of the list.

▶ Press left-hand Touch Control ③. The selected menu will be displayed in full.

Calling up displays on the Performance menu

On-board computer:

↳ Performance

▶ **To select a display:** swipe upwards or downwards on the left-hand Touch Control.

Displays on the Performance menu:

- Warm-up
- Engine data
- SETUP
- G-meter

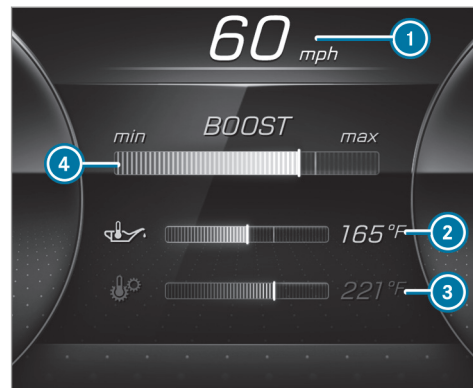

Warm-up (example)

- ① Digital speedometer
- ② Engine oil temperature
- ③ Transmission oil temperature
- ④ Boost pressure

If the engine or transmission is not at normal operating temperature, the multifunction display will show temperature ② or ③ in blue. Avoid

using the full engine power output during this time.

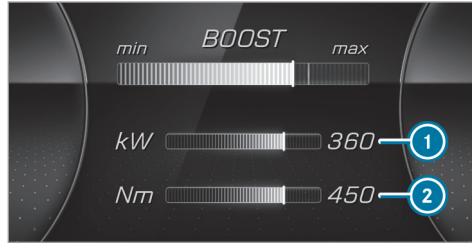

Engine data (example)

- ① Current power output
- ② Current torque

When current power output ① or current torque ② reaches the maximum value, the digital value will briefly be stationary and turn red. The bar display will continue.



SETUP in Mercedes-AMG vehicles (example)

- ① Drive system setting:
Reduced/Moderate/Sport/Dynamic/Race
- ② Transmission position:
D/M
- ③ AMG DYNAMICS:
Basic/Advanced/Pro/Master
- ④ Suspension tuning:
Comfort/Sport/Sport+
- ⑤ Exhaust system:
Balanced/Powerful

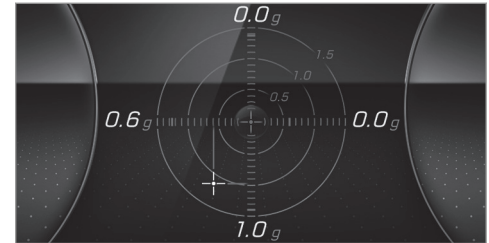

G-meter (example)

While the vehicle is in motion, the G-meter shows the forces that are exerted on the vehicle occupants both laterally and in the direction of travel. The maximum values are represented by red markings.

- ▶ **To reset the G-meter:** press the left-hand Touch Control.
- ▶ Select **Yes**.
- ▶ Press the left-hand Touch Control.

Function of the Head-up Display

The Head-up Display projects the following information above the cockpit into the driver's field of vision:

- Driving speed
- Information from the navigation system
- Information from the driving systems and driving safety systems
- Some warning messages

Depending on the vehicle's equipment, different content can be shown in the three areas of the Head-up Display.

Mercedes-AMG display content

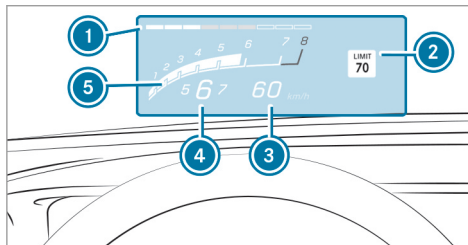

- ① Protection from reaching the overrevving range
- ② Detected instructions and traffic signs
- ③ Current speed
- ④ Currently selected gear, gearshift options with manual shifting
- ⑤ Current engine speed

Depending on the vehicle's equipment, you can select further AMG displays in addition to the standard displays on the [Display Content](#) menu.

In vehicles with AMG TRACK PACE, you can display additional content:

- Speed and gear display
- Lap and sector times
- Acceleration and braking
- Track layout graphics

i The content that can be displayed will vary depending on the settings.

When you receive a call, the  **Incoming Call** message will appear on the Head-up Display.

In audio mode, the station name or track will be shown temporarily when the audio source is being actively operated.

System limits

The visibility of the displays will be affected by the following conditions:

- Seat position
- Image position setting
- Ambient light
- Wet road
- Objects on the display cover

- Polarization in sunglasses
- ① In extreme sunlight, sections of the display may appear washed out. You can correct this by switching the Head-up Display off and on again.

AMG TRACK PACE

General information

With AMG TRACK PACE, the driving characteristics on race tracks can be analyzed and optimized. You can drive previously stored race tracks (e.g. Hockenheimring), or new tracks can be recorded and stored. The driven lap times are stored for every track. These can be analyzed and compared to other lap times to achieve the best possible race results. Additionally, acceleration and braking procedures can be measured and stored.



Please note: Use AMG TRACK PACE only on closed-off routes outside the public traffic area. Adapt your driving style to your personal abilities and the environmental conditions. As the driver, you are solely responsible for driving your vehicle. Park your vehicle safely before operating the application.

Setting Track Race



Multimedia system:

↳ TRACK PACE ▶▶ Track Race

Recording a new track

- ▶ Select  **New Track** .
- ▶ Select  **Start Record**. at the desired starting point.
The track recording starts at this point.

During track recording, sectors can be set to divide up the track.

- ▶ Select  **Set Sector**.
- ▶ Select  **Stop Recording** to end track recording or cross the starting line again.
- ▶ Confirm the prompt with .
- ▶ Select the weather.

 The temperature is determined automatically.



- ▶ After ending, select  to save the track.
- ▶ Enter a name.

- ▶ Press  to confirm.
The track is saved under the name entered.

Searching by track name

- ▶ Select  **All Tracks** .
- ▶ Enter the track name.
Tracks with the searched name are displayed.



Measuring time on a saved track



- ▶ Select  **All Tracks** .
- ▶ Select the desired track.
- ▶ Select .
- ▶ Select **Start Race** if you are already stood at the starting line.

or

- ▶ Select **Navigate to** for navigation to the starting line.

Timekeeping begins automatically when the starting line has been crossed.

-  When  is selected, the track display can be switched to AR.
- ▶ Select  **Stop Race** to end timekeeping.

- ▶ Confirm the prompt with .
- ▶ Select the weather.
- ▶ Select  **Save Track** to save the times driven for this track.

Showing displays during Track Race

The following displays can be shown:

- Tire temperature
- Mini map
- Sector overview
- Engine data
- G-force display
- Lap overview
- ▶ Select  **Start Race**.





- ▶ Select  **Setup**.
- ▶ Pull the desired display from the grid on the left or right edge of the media display. The displays are shown during the Track Race.

By selecting  on the active display, you can deactivate this.

- ▶ Select  to return to the navigation map view.

Displaying the analysis

- ▶ Select  **All Tracks** .
An overview of all the driven tracks appears.
- ▶ Select a track.
- ▶ Select a session.
The following data is displayed:
 - Lap and sector times
 - Average and maximum permissible speed
 - Driver

- Vehicle
 - Date
 - Weather
 - ▶ Select **Compare to Rec.** to use a different session as a reference value.
 - ▶ Select  to return to the overview.
 - ▶ Select  **Diagram**.
 - ▶ Set parameters  and .
- The analysis is displayed.





- ① Lap overview
- ② Parameter 1
- ③ Parameter 2
- ④ Trajectory of parameter 1 (e.g. time)
- ⑤ Trajectory of parameter 2 (e.g. speed)
- ⑥ The following values can be set for parameters 1 and 2, for example:
 - Speed



- Longitudinal/lateral acceleration
- Steering angle
- Engine speed
- Engine oil/tire temperature

Based on the analysis you can check and optimize driving characteristics for any position on the track.

Exporting tracks (USB)

- ▶ Select  **Tracks**.
An overview of all stored tracks appears.
- ▶ Select the desired track.
- ▶ Select options  for the desired track.
- ▶ Select **Export**.
The selected track can be exported to a USB storage device connected to the vehicle.

Editing tracks and recordings

- ▶ Select  **Tracks**.
- ▶ Select the desired track.
- ▶ Select options  for the desired track.
- ▶ Select **Rename** or **Delete**.

or

- ▶ Select a track.
- ▶ Highlight the desired recording.
- ▶ Select  options.
- ▶ Select **Export to...** or **Delete**.

Setting Drag Race

Multimedia system:

↳ TRACK PACE ▶ Drag Race

Measuring acceleration

- ▶ Select  **Drag Options**.
- ▶ Select **Acceleration**.
- ▶ Set a starting speed or select **Automatic**. Measurement begins as soon as the specified starting speed has been reached.

- ▶ Set a target speed. Measurement stops as soon as the specified target speed has been reached.
- ▶ Pull away and start the measurement. Measurement begins when the vehicle accelerates.

Measurement can be stopped early by stopping the vehicle.

Quarter-mile race

- ▶ Select  **Drag Options**.
- ▶ Select **Quarter Mile**.
- ▶ Set a target distance. Measurement stops as soon as the specified target distance has been reached.
- ▶ Pull away and start the measurement. Measurement begins when the vehicle accelerates. Timing runs until the target distance or a maximum of one mile has been traveled.

Measurement can be stopped early by stopping the vehicle.

Measuring braking

- ▶  **Drag Options**
- ▶ Select **Braking**.
- ▶ Set a starting speed or select **Automatic**.
- ▶ Pull away and start the measurement.
- ▶ Brake to a standstill. Measurement is incremental, in steps of 5 mph (10 km/h) to a standstill. If the braking procedure is started e.g. at a speed of 58 mph (157 km/h), measurement starts as soon as 55 mph (150 km/h) has been reached.

Storing and calling up measurement values

If measurement is completed or canceled, a prompt appears asking whether the measurement should be saved.

- ▶ Confirm the prompt with  to save.

Calling up saved measurements

- ▶ Select  **History**.
- ▶ Select **Acceleration**, **Quarter Mile** or **Braking**.

- ▶ Select a measurement.
The desired measurement is displayed in detail.

or

- ▶ Delete a measurement.

Calling up the telemetry display

Multimedia system:

↳ TRACK PACE ▶ Telemetry

The telemetry display shows current vehicle data as a digital value and as a diagram. Up to three parameters can be selected that are to be shown in the display.

For example:

- Engine speed
 - Wheel angle
 - Speed
 - Steering angle
- ▶ Set the desired parameters.

- ▶ Set the time.
The set parameters are evaluated in the diagram for the time set.

Configuring AMG TRACK PACE

Requirements:

To connect a mobile device to the TRACK PACE app:

- The TRACK PACE app is installed on the mobile end device.
- The mobile end device is connected to the multimedia system via Wi-Fi.

Multimedia system:

↳ TRACK PACE ▶ Options

Connecting a mobile device via the TRACK PACE app

The TRACK PACE app makes it possible to record videos and to synchronize them with stored tracks.

- ▶ Select TRACK PACE App.

- ▶ Select **AUTHORIZE NEW DEVICE**.
Available devices are displayed.
- ▶ Start the TRACK PACE app on the device to be connected and follow the instructions.
- ▶ Confirm the authorization prompt.
- ▶ Scan the QR code on the media display.
The device is authorized.

De-authorizing the mobile device

- ▶ Select TRACK PACE App.
- ▶ Select **De-authorize device**.
- ▶ Select a device.
- ▶ Confirm the message prompt with Yes.
The device is de-authorized.

Setting the TRACK PACE display in the Head-up Display

- ▶ Select **HUD Content**.
- ▶ Activate or deactivate the desired contents.
The contents in the Head-up Display are adapted.

ⓘ For further information on the Head-up Display, see (→ page 30).

Setting acoustic feedback

- ▶ Select [Acoustic feedback](#).
A scale with values from 0 to 85 is shown.
- ▶ Select a setting.

- ▶ Activate or deactivate the function.

Displaying statistics

- ▶ Select [Statistics](#).
Statistics on the current user profile are displayed.
The following data is displayed:
 - Driving time
 - Track driven
 - Tracks recorded
 - Track Races recorded
 - Laps recorded
 - Drag Races recorded
 - Maximum design speed

Activating the ambient light

If this function is active, the vehicle interior is lit red or green depending on Delta Time.

- ▶ Select [Ambient light](#).

Flat tire

TIREFIT kit storage location

The TIREFIT kit is located under the cargo compartment floor.

Mercedes-AMG E 63 4MATIC+ and Mercedes-AMG E 63 S 4MATIC+: the TIREFIT kit is in the trunk beneath the partition.

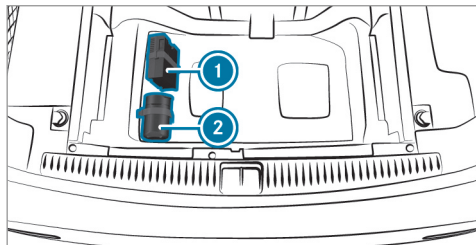

- ① Tire inflation compressor
- ② Tire sealant bottle

Overview of the tire-change tool kit

Apart from some country-specific variants, vehicles are not equipped with a tire-change tool kit. For more information on which tire-changing tools are required and approved for performing a wheel change on your vehicle, consult a qualified specialist workshop.

You require the following tools, for example, to change a wheel:

- Jack
- Chock
- Lug wrench
- Alignment bolt

The tire-change tool kit is located in tool bag ① under the cargo compartment floor.

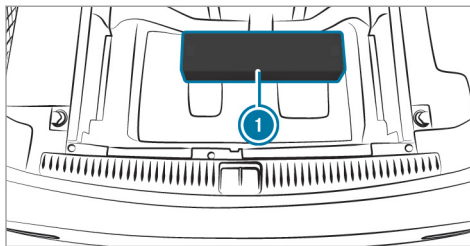

The tool bag contains:

- Jack
- Lug wrench
- Alignment bolt
- Folding chock
- Ratchet for jack

Changing a wheel

- ▶ Be sure to also observe the notes on changing a wheel in the Operator's Manual of your vehicle.

Vehicles with AMG Driver's Package:

⚠ WARNING Risk of accident caused by non-approved tire types

If you use tire types that have not been adapted to changes made to the factory speed limit, this can have the following consequences:

- The tires do not exhibit the required quality characteristics and are not suitable for high speeds or the relevant driving dynamics.
- The tires wear unevenly and could, therefore, affect the roadworthiness of the vehicle.
- ABS, ESP® and cruise control operation are restricted.

This can jeopardize road safety.

- ▶ Only use tire types that have been approved for the maximum road speed set and the vehicle.

Vehicles with AMG ceramic high-performance composite braking system:

! **NOTE** Damage to the ceramic brake disk when changing a wheel

Mercedes-AMG vehicles with ceramic brake disks: during removal and repositioning of the wheel, the wheel rim may strike the ceramic brake disk and damage it.

- ▶ Take particular care.
 - ▶ Ask another person for assistance or use a second centering pin.
- ▶ When changing the wheel, avoid exerting any force on the brake discs.
This can lead to impaired comfort during braking.

Operating fluids

Fuel

Notes on fuel grades for Mercedes-AMG vehicles

Observe the information on operating fluids in the vehicle Operator's Manual.

! NOTE Damage caused by the wrong fuel

Even small amounts of the wrong fuel could result in damage to the fuel system, the engine and the emission control system.

- ▶ Only refuel with low-sulfur gasoline.

This fuel may contain up to 10% ethanol by volume. Your vehicle is suitable for use with E10 fuel.

Never refuel with one of the following fuels:

- Diesel
- Gasoline with more than 10% ethanol by volume, e.g. E15, E85, E100

- Gasoline with more than 3% methanol by volume, e.g. M15, M30, M85, M100
- Gasoline with additives containing metal

If you have accidentally refueled with the wrong fuel:

- ▶ do not switch the ignition on.
- ▶ Consult a qualified specialist workshop.

If the available fuel is not sufficiently low in sulfur, this can produce unpleasant odors.

Only refuel using unleaded premium grade gasoline with at least 91 AKI/95 RON.

As a temporary measure, if the recommended fuel is not available, you may also use unleaded regular gasoline: Note the octane number on the information label in the fuel filler flap (see the vehicle Operator's Manual).

Never refuel using gasoline with an even lower RON.

! NOTE Premature engine wear through unleaded regular gasoline

Impairment of the longevity and performance of the engine.

If unleaded premium grade gasoline is unavailable and you have to refuel using unleaded regular gasoline:

- ▶ Only fill the fuel tank to half full with unleaded regular gasoline and refill as soon as possible with unleaded premium grade gasoline.
- ▶ Do not drive at the maximum design speed.
- ▶ Avoid sudden acceleration and engine speeds over 3000 rpm.

Further information on fuel is available at the following locations:

- at a gas station
- at a qualified specialist workshop
- on the <https://www.mbusa.com> (USA only)

Tank content and reserve fuel

Model	Total capacity
All models	21.1 US gal (80.0 liters)
Model	of which reserve fuel
All models	3.2 US gal (12.0 liters)

Quality and capacity of engine oil

Gasoline engines	MB-Freigabe or MB-Approval
Mercedes-AMG E 53 4MATIC+	229.51, 229.52, 229.61 229.71*
Mercedes-AMG E 63 S 4MATIC+	229.5* 229.51

* Recommended for lowest possible fuel consumption (lowest SAE viscosity class in each case; observe possible restrictions of the approved SAE viscosity classes).

To achieve the lowest possible fuel consumption, it is recommended to use the engine oil specifications marked in the table for the lowest SAE viscosity class. Possible restrictions of the approved SAE viscosity classes must be observed.

Mercedes-AMG E 63 S 4MATIC+: only use engine oils of viscosity class SAE 0W-40 or SAE 5W-40.

The following values refer to an oil change, including the oil filter.

Model	Capacity
Mercedes-AMG E 53 4MATIC+	9.0 US qt (8.5 liters)
All other models	9.5 US qt (9.0 liters)

Coolant capacity

Missing values were not yet available at the time of going to press.

Model	Capacity
Mercedes-AMG E 53 4MATIC+	
Mercedes-AMG E 63 S 4MATIC+	16.2 US qt (15.3 liters)

Filling capacity for refrigerant and PAG oil

Missing values were not yet available at the time of going to press.

Model	Refrigerant
Mercedes-AMG E 53 4MATIC+	
Mercedes-AMG E 63 S 4MATIC+	22.2 ± 0.4 oz (630 ± 10 g)

Model	PAG oil
Mercedes-AMG E 53 4MATIC+	
Mercedes-AMG E 63 S 4MATIC+	2.8 ± 0.4 oz (80 ± 10 g)

Vehicle data

Vehicle dimensions

The heights specified may vary as a result of the following factors:

- Tires
- Load
- Condition of the suspension
- Optional equipment

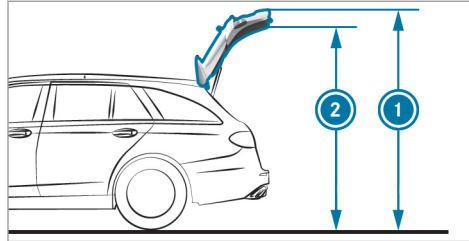

Missing values were not yet available at the time of going to press.

Model	① Height when opened	② Headroom
Mercedes-AMG E 53 4MATIC+		75.0 in (1897 mm)
All other models	81.8 in (2077 mm)	75.2 in (1910 mm)

Mercedes-AMG E 53 4MATIC+	
Vehicle length	195.5 in (4965 mm)
Vehicle width including outside mirrors	81.3 in (2065 mm)
Vehicle height	57.5 in (1461 mm)
Wheelbase	115.7 in (2939 mm)
Turning radius	41.0 ft (12.50 m)
All other models	
Vehicle length	196.7 in (4996 mm)
Vehicle width including outside mirrors	81.3 in (2065 mm)
Vehicle height	58.0 in (1474 mm)

44 Technical data

All other models	
Wheelbase	115.7 in (2939 mm)
Turning radius	41.0 ft (12.50 m)

Weights and loads

Please observe the following notes for the specified vehicle data:

- Items of optional equipment increase the curb weight and reduce the payload.

Roof load

Model	Maximum roof load
All models	220 lb (100 kg)

Maximum design speeds

The following values only apply to vehicles with the AMG Driver's Package.

Missing data was not available at the time of going to press.

Maximum design speeds

Mercedes-AMG E 53 4MATIC+	Maximum speed
1st gear	
2nd gear	
3rd gear	
4th gear	
5th gear	
6th gear	
7th gear	
8th gear	
9th gear	

Mercedes-AMG E 63 S 4MATIC+	Maximum speed
1st gear	33 mph (53 km/h)
2nd gear	55 mph (88 km/h)
3rd gear	79 mph (127 km/h)
4th gear	109 mph (175 km/h)
5th gear	147 mph (236 km/h)
6th gear	177 mph (284 km/h)
7th gear	180 mph (290 km/h)
8th gear	180 mph (290 km/h)
9th gear	180 mph (290 km/h)

Display messages

Vehicle

Display messages	Possible causes/consequences and ► Solutions
Electronic Rear Axle Differential Lock Inoperative	<ul style="list-style-type: none"> * The electronic rear axle locking differential is inoperative. <ul style="list-style-type: none"> ► Consult a qualified specialist workshop.
Electronic Rear Axle Differential Lock Currently Unavailable	<ul style="list-style-type: none"> * The motor of the electronic rear axle locking differential is overheating. <ul style="list-style-type: none"> ► Let the electronic rear axle locking differential cool down by driving defensively.

Driving systems

Display messages	Possible causes/consequences and ► Solutions
RACE START Not Possible See Operator's Manual	<ul style="list-style-type: none"> * Possible causes: <ul style="list-style-type: none"> • The activation conditions have not been fulfilled (→ page 19).
RACE START Canceled	<ul style="list-style-type: none"> * Possible causes: <ul style="list-style-type: none"> • You released the accelerator pedal during RACE START. • You depressed the brake pedal during RACE START. <p>You can try RACE START again at the next start.</p>

46 Display messages and warning/indicator lamps

Display messages	Possible causes/consequences and ► Solutions
DRIFT MODE Currently Unavailable See Operator's Manual	* Possible causes: <ul style="list-style-type: none">• The activation conditions have not been fulfilled (→ page 21).
 <p>Malfunction Drive at Max. 50 mph</p>	* The AMG adaptive sport suspension system + is malfunctioning. The vehicle's handling characteristics may be affected. <ul style="list-style-type: none">► Do not drive at speeds greater than 50 mph (80 km/h).► Consult a qualified specialist workshop.



Warning and indicator lamps

Driving systems

Warning/indicator lamp	Possible causes/consequences and ► Solutions
 <p>Suspension warning lamp (yellow)</p>	The yellow AMG adaptive sport suspension system + warning lamp is lit. <ul style="list-style-type: none">* There is a malfunction in the AMG adaptive sport suspension system +.<ul style="list-style-type: none">► Note the messages on the multifunction display.

Driving safety systems

Warning/indicator lamp	Possible causes/consequences and ► Solutions
	<p>The yellow ESP[®] OFF warning lamps are lit while the engine is running.</p> <p>*ESP[®] is deactivated.</p> <p>Other driving systems and driving safety systems may also be inoperative.</p> <div style="background-color: #f0f0f0; padding: 5px; margin: 10px 0;"> <p>▲ WARNING Risk of skidding when driving with ESP[®] deactivated</p> <p>ESP[®] does not act to stabilize the vehicle. The availability of further driving safety systems is also limited.</p> <ul style="list-style-type: none"> ▶ Drive on carefully. ▶ Deactivate ESP[®] only for as long as the situation requires. <p>If ESP[®] cannot be activated, ESP[®] is malfunctioning.</p> <ul style="list-style-type: none"> ▶ Have ESP[®] checked immediately at a qualified specialist workshop. </div> <p>► Observe the notes on deactivating ESP[®] (→ page 16).</p>

Warning/indicator lamp	Possible causes/consequences and ► Solutions
 <p>ESP SPORT</p>	<p>ESP® SPORT is activated while the engine is running.</p> <p>*When ESP® SPORT is activated, ESP® will stabilize the vehicle only to a limited extent.</p> <div style="background-color: #f0f0f0; padding: 5px;"> <p>▲ WARNING Risk of skidding if ESP® SPORT is used incorrectly</p> <p>When you activate ESP® SPORT, there is an increased risk of skidding and having an accident.</p> <ul style="list-style-type: none"> ▶ Activate ESP® SPORT only in the circumstances described below. </div> <p>► Observe the notes on activating ESP® SPORT(→ page 16).</p>
 <p>DRIFT MODE warning lamp</p>	<p>DRIFT MODE is activated while the engine is running.</p> <p>* ▲ WARNING Risk of skidding and having an accident from wheels spinning</p> <p>When you use DRIFT MODE, ESP® is not available.</p> <p>There is an increased risk of skidding and having an accident.</p> <ul style="list-style-type: none"> ▶ Do not use DRIFT MODE on normal roads. ▶ DRIFT MODE may only be activated and used on closed race circuits, not on public roads. ▶ Make sure that no persons or obstacles are in the close vicinity of your vehicle. <p>► Observe the notes on activating DRIFT MODE (→ page 20).</p>

A

Acceleration	
see Kickdown	
Airbag	
see Side airbag	
AMG	
Menu (on-board computer)	26
Steering wheel control element	25
Steering-wheel buttons	25
AMG adaptive sport suspension system	
.....	23
Selecting the suspension setting	23
Setting	24
AMG adaptive sport suspension system +	
Suspension	22
AMG ceramic high-performance composite brake system	13
AMG Performance adjustable exhaust system	13
Function	12
Operating	13
AMG Performance steering wheel	25

AMG TRACK PACE

Configuring	36
Drag Race	35
General information	32
Telemetry display	36
Track Race	32

Authorized Mercedes-Benz Center

 see Qualified specialist workshop

Authorized workshop

 see Qualified specialist workshop

Automatic engine start (ECO start/stop function)	12
---	----

Automatic engine stop (ECO start/stop function)	12
--	----

Automatic transmission

Drive programs	13
DYNAMIC SELECT switch	13
Kickdown	16
Manual gearshifting	15
Oil temperature (on-board computer, Performance menu)	28
Steering wheel paddle shifters	15

B

Boost pressure (on-board computer, Performance menu)	28
---	----

Brakes

AMG ceramic high-performance composite brake system	13
New/replaced brakepads/brake discs	11
Notes on breaking-in a new vehicle	11

C

Changing a wheel	
Removing a wheel	39

Changing gears	15
Manually	15

Chock	39
Storage location	39

Chock

 see Chock

Climate control	
Filling capacity for PAG oil	42
Refrigerant filling capacity	42

Cockpit	4
Overview	4

Comfort mode

see AMG adaptive sport suspension system

Computer

see On-board computer

Coolant (engine)

Capacity 42

D**Dashboard**

see Cockpit

Dealership

see Qualified specialist workshop

Display messages

 **Malfunction Drive at Max. 50 mph** 46

DRIFT MODE Currently Unavailable
See Operator's Manual 46

Electronic Rear Axle Differential Lock
Currently Unavailable 45

Electronic Rear Axle Differential Lock
Inoperative 45

RACE START Canceled 45

RACE START Not Possible See Operator's Manual 45

Drag Race

Setting 35

DRIFT MODE

Activating 21

Activation conditions 21

Deactivating 21

Function 20

Drive programs

see DYNAMIC SELECT

Driving safety system

ESP® (Electronic Stability Program) 16

Driving system

AMG adaptive sport suspension system + 22

Driving tips

AMG ceramic high-performance
composite brake system 13

Notes on breaking-in a new vehicle 11

DYNAMIC SELECT 13

Drive programs 13

Function 13

E**E10** 41**ECO start/stop function** 12

Automatic engine start 12

Automatic engine stop 12

Method of operation 12

Emotion Start

Starting the vehicle 11

Engine

ECO start/stop function 12

Engine oil

Capacity 42

MB-Freigabe or MB-Approval 42

Quality 42

Temperature (on-board computer,
Performance menu) 28**ESP® (Electronic Stability Program)**

Activating/deactivating 19

ESP® SPORT 16

Function/notes 16

Status display (on-board computer,
Performance menu) 28

ESP® SPORT

Function/notes 16

F**Fuel**

E10 41
 Flexible fuel vehicles 41
 Fuel reserve 42
 Gasoline 41
 Quality (gasoline) 41
 Sulfur content 41
 Tank content 42

G

G-meter (on-board computer, Performance menu) 28
Gasoline 41
Gear display (on-board computer, Performance menu) 28
Gearshift recommendation 15
Glide mode 16

H**Head-up Display**

Function 30

I**Instrument display**

AMG displays 26

J**Jack**

Storage location 39

K

Kickdown 16
 Using 16

L**Limited Warranty**

Vehicle 9

Locking differential

see Rear axle locking differential

M**Maximum speeds** 44**Menu (on-board computer)**

AMG displays 26
 Overview 26
 Performance 26, 28

N**Notes on breaking-in a new vehicle** 11**O**

On-board computer 26
 AMG menu 26
 Operating 26
 Overview of menus 26
 Performance menu 26, 28

Operating fluids

Fuel (gasoline) 41

Operating safety

Information 7

Operating system

see On-board computer

Operator's Manual

Vehicle equipment 7

P**Performance (on-board computer, Performance menu)** 28**Power output (on-board computer, Performance menu)** 28**Q****Qualified specialist workshop** 8**R****RACE START**

Activating 19

Activation conditions 19

Function 19

Rear axle locking differential 12**Reserve**

Fuel 42

Rocking free 14**Roof load** 44**S****Seat belts**

Reduced protection 10

Selecting a gear

see Changing gears

Service center

see Qualified specialist workshop

SETUP (on-board computer, Performance menu) 28**Shift paddles**

see Steering wheel paddle shifters

Shifting gears

Gearshift recommendation 15

Side airbag 10

Protection 10

Specialist workshop 8**Sport Plus suspension setting**

see AMG adaptive sport suspension system

Sport suspension setting

see AMG adaptive sport suspension system

Sports exhaust

see AMG Performance adjustable exhaust system

Start/Stop button

Emotion Start 11

Start/stop function

see ECO start/stop function

Steering wheel paddle shifters 15**Sulfur content** 41**Suspension**

AMG adaptive sport suspension system + 22

Selecting the suspension setting 23

Setting the suspension level 24

Suspension level

Setting 24

T**Tailgate**

Opening dimensions 43

Tank content

Fuel 42

Reserve (fuel) 42



Telemetry display	
Calling up	36
Temperature	
Engine oil (on-board computer, Performance menu)	28
Transmission oil (on-board computer, Performance menu)	28
Tire inflation compressor	
see TIREFIT kit	
Tire-change tool kit	
Overview	39
TIREFIT kit	38
Storage location	38
Tires	
Installing	39
Removing	39
Tool	
see Vehicle tool kit	
Torque (on-board computer, Performance menu)	28
Touch Control	
On-board computer	26

Track Race	
Setting	32

V

Vehicle	
Correct use	8
Equipment	7
Limited Warranty	9
Qualified specialist workshop	8
Rocking free	14
Starting (Emotion Start)	11
Vehicle data	
Maximum speeds	44
Roof load	44
Turning circle	43
Vehicle height	43
Vehicle length	43
Vehicle width	43
Wheelbase	43
Vehicle dimensions	43
Vehicle tool kit	38
TIREFIT kit	38

W

Warm-up (on-board computer, Performance menu)	28
Warning/indicator lamp	
 DRIFT MODE warning lamp	48
 Suspension warning lamp (yellow)	46
Warranty	9
Wheel change	
Mounting a new wheel	39
Wheels	
Installing	39
Removing	39
Workshop	
see Qualified specialist workshop	





