



Digital - in the vehicle

Explore the Operator's Manual in the multimedia system under "Vehicle." Start with quick start, discover highlights and useful tips.



Vehicle document wallet

You can find comprehensive printed information about operating your vehicle, the Service Booklet and your vehicle warranty here.



1675841425

Order no. P167 0635 13 Part no. 167 584 14 25
Edition B-2023

GLE

Mercedes-Benz



GLE

Operator's Manual

Mercedes-Benz



Front passenger air bag warning

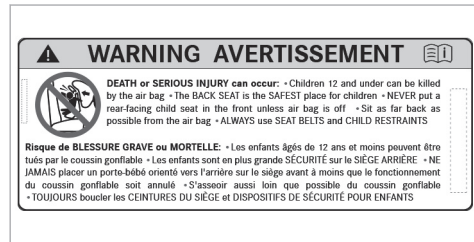
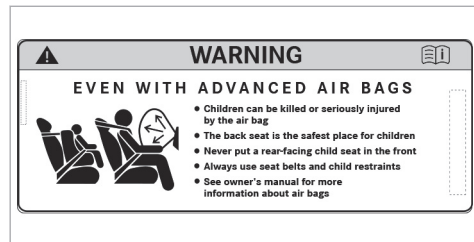

Air bag warning sticker for USA and Canada

WARNING Risk of injury or fatal injuries if the front passenger air bag is enabled

If the front passenger air bag is enabled, a child on the front passenger seat may be struck by the front passenger air bag in the event of an accident.

- ▶ NEVER use a rearward-facing child restraint system on a seat with an ENABLED FRONT AIR BAG. This can result in the DEATH of or SERIOUS INJURY to the CHILD.

Observe the chapter "Children in the vehicle".

Publication details

Internet

Further information about Mercedes-Benz vehicles and about Mercedes-Benz AG can be found on the following websites:

<https://www.mbusa.com> (USA only)

<https://www.mercedes-benz.ca> (Canada only)

Documentation team

©Mercedes-Benz AG: Not to be reprinted, translated or otherwise reproduced, in whole or in part, without written permission from Mercedes-Benz AG.

Vehicle manufacturer

Mercedes-Benz AG

Mercedesstraße 120

70372 Stuttgart

Germany

As at 11.07.22

Welcome to the world of Mercedes-Benz

Before your first drive, please read this Operator's Manual carefully and familiarize yourself with your vehicle. For your own safety and a longer service life of the vehicle, follow the instructions and warning notices in this Operator's Manual. Disregarding them may lead to damage to the vehicle or injury to people.

Damage to the vehicle resulting from the disregard of the instructions is not covered by the Mercedes-Benz Limited warranty.

The standard equipment and product description of your vehicle may vary and depends on the following factors:

- Model
- Order
- National version
- Availability

Your vehicle may therefore differ from that shown in the descriptions and illustrations in individual cases.

Mercedes-Benz reserves the right to introduce changes in the following areas:

- Design
- Equipment
- Technical features

The following documents are components of the vehicle:

- Digital operator's manual
- Printed Operator's Manual
- Maintenance Booklet
- Supplementary manuals relating to specific equipment
- Supplementary documents

Keep these documents in the vehicle at all times. Ensure that all documents are in the vehicle or passed on in the event of sale or rental.

Mercedes-Benz USA, LLC

Mercedes-Benz Canada, Inc.

A Mercedes-Benz Group AG Company

1675841425



Symbols	5	Notes on assembling the license plate on the front license plate holder	33	Airbags	60
At a glance	6	National information for components relevant to radio regulation	33	Safely transporting children in the vehicle	61
Cockpit	6	Diagnostics connection	34	Brief overview of most important points	61
Cockpit (plug-in hybrid)	10	Qualified specialist workshop	35	Important safety notes	62
Indicator and warning lamps	12	Correct use of the vehicle	35	Suitable child restraint systems for the transport of children	67
Overhead control panel	16	Sport Utility Vehicle	35	Securing the child restraint system	68
Door operating unit and seat adjustment	18	Notes for persons with electronic medical aids	36	Child safety locks	74
Control settings in the rear passenger compartment	20	Problems with your vehicle	37	Opening and closing	76
Emergencies and breakdowns	22	Reporting safety defects	37	SmartKey	76
Digital Operator's Manual	24	Limited Warranty	38	Doors	80
Calling up the Digital Operator's Manual	24	QR code for rescue card	38	Cargo compartment	84
General notes	25	Data storage	38	Side windows	89
Protecting the environment	25	Copyright	43	Sliding sunroof	93
Mercedes-Benz GenuineParts	26	Occupant safety	44	Roller sun blinds	97
Operator's Manual	27	Brief overview of the most important points	44	Anti-theft protection	98
Touch-sensitive controls	27	Information on the automatic functions of the restraint system	52	Seats and stowing	101
Mercedes me app	28	Purpose and function of the restraint system	55	Notes on the correct driver's seat position ..	101
Service and vehicle operation	28	Seat belts	60	Notes on grab handles	101
Operating safety	29			Seats	102

Steering wheel	114		
Easy entry and exit feature	116		
Memory function	118		
Stowage areas	119		
Cup holder	134		
Ashtray and cigarette lighter	135		
Sockets	135		
Wireless charging of the mobile phone and connection with the exterior antenna	137		
Installing/removing the floor mats	139		
<hr/>			
Light and visibility	141		
Exterior lighting	141		
Interior lighting	146		
Windshield wiper and windshield washer system	147		
Mirrors	152		
Area permeable to radio waves on the windshield	155		
Infrared-reflective windshield function	156		
<hr/>			
Climate control	157		
Overview of climate control systems	157		
Operating the climate control system	158		
<hr/>			
Driving and parking	168		
Driving	168		
DYNAMIC SELECT	190		
Automatic transmission	196		
Function of 4MATIC	201		
Refueling	201		
Charging the high-voltage battery (plug-in hybrid)	204		
Parking	219		
Driving and driving safety systems	228		
Trailer hitch	301		
Vehicle towing instructions	305		
<hr/>			
Driver's display	306		
Notes on the driver's display	306		
Operating the driver's display	306		
Driver display menus	307		
Head-up Display	309		
Vehicles with a 48 V on-board electrical system	310		
Function of the power meter	310		
Overview of status displays on the driver's display	311		
<hr/>			
MBUX voice assistant	313		
Notes on operating safety	313		
Notes on operating safety	313		
Operation	313		
Using the Voice Control System effectively ..	315		
Essential voice commands	316		
<hr/>			
MBUX multimedia system	321		
Overview and operation	321		
System settings	332		
Plug-in hybrid settings	337		
Off-road menu	338		
Navigation and traffic	339		
Telephone	350		
Mercedes me Apps	353		
Mercedes-Benz emergency call system	360		
Radio & media	363		
Sound settings	369		
<hr/>			
Maintenance and care	370		
ASSYST PLUS service interval display	370		
Maintenance Management	371		
Telediagnosis	371		
Engine compartment	372		

4 Contents

Cleaning and care 378

Breakdown assistance 388

Emergency 388

Flat tire 390

Battery (vehicle) 397

Tow starting or towing away 403

Electrical fuses 410

Wheels and tires 414

Notes on noise or unusual handling characteristics 414

Notes on regularly inspecting wheels and tires 414

Notes on snow chains 415

Tire pressure 415

Loading the vehicle 422

Tire labeling 426

Definition of terms for tires and loading 431

Changing a wheel 433

Emergency spare wheel 443

Collapsible spare wheel 445

Technical data 448

Notes on technical data 448

Vehicle electronics 448

Radio regulations 450

Vehicle identification plate, VIN and engine number overview 450

Operating fluids 452

Vehicle data 460

Trailer hitch 465

Display messages and warning/indicator lamps 468

Display messages 468

Warning and indicator lamps 536

Index 554

In this Operator's Manual, you will find the following symbols:

⚠ WARNING Danger due to failure to observe the warning notices

Warning notices draw your attention to hazards that may endanger your health or life, or the health or life of others.

▶ Observe the warning notices.

🌿 ENVIRONMENTAL NOTE Environmental damage due to failure to observe environmental notes

Environmental notes include information on environmentally responsible behavior or environmentally responsible disposal.

▶ Observe environmental notes.

! NOTE Damage to property due to failure to observe notes on material damage

Notes on material damage inform you of risks which may lead to your vehicle being damaged.

▶ Observe notes on material damage.

ⓘ These symbols indicate useful instructions or further information that could be helpful to you.

▶ Instruction

(→ page) Further information on a topic

Display Display in the central display







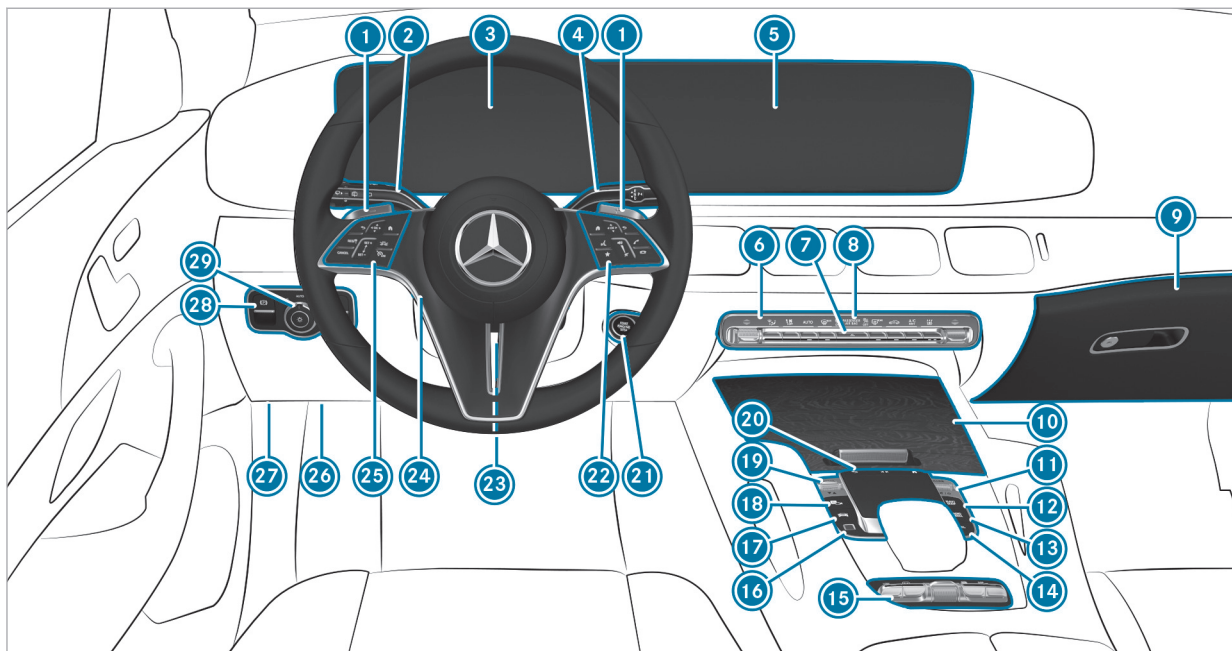







↪ Highest menu level, which is to be selected in the multimedia system

▶▶ Relevant submenus, which are to be selected in the multimedia system









* Indicates a cause



Left-hand-drive vehicles

①	Steering wheel paddle shifters	→	198	⑮	Switch panel for:			
②	Combination switch	→	142		Off-road menu	→	338	
③	Driver's display	→	306	M	Manual gearshifting	→	198	
④	DIRECT SELECT lever	→	196		AIRMATIC or	→	266	
⑤	Central display	→	321		E-ACTIVE BODY CONTROL	→	272	
⑥	Climate control systems	→	158		Activates/deactivates ESP®	→	231	
⑦	 Hazard warning lamps	→	143		Downhill Speed Regulation	→	246	
⑧	PASSENGER AIR BAG indicator lamp	→	49	⑯		Fingerprint sensor	→	321
⑨	Glove box	→	122	⑰		Calls up vehicle functions	→	323
⑩	Stowage compartment	→	122	⑱		Active Parking Assist	→	293
⑪	 Controller for volume and switching sound on/off	→	321	⑲	DYNAMIC SELECT switch	→	194	
	 Switches the MBUX multimedia system on/off	→	321	⑳	Touchpad	→	323	
⑫	 Calls up navigation	→	323	㉑	Start/stop button	→	172	
⑬	 Calls up radio or media	→	323		ECO start/stop function	→	183	
⑭	 Calls up the telephone	→	323	㉒	Control panel for the MBUX multimedia system	→	323	
				㉓	Adjusts the steering wheel manually	→	114	

8 At a glance – Cockpit

 24	Adjusts the steering wheel electrically	→	115	 Active Distance Assist DISTRONIC	→	241	
 24	Switches the steering wheel heater on/off	→	115	 26	Diagnostics connection	→	34
 25	Control panel:			 27	Opens the hood	→	372
	Driver's display	→	306	 28	Electric parking brake	→	224
	Cruise control	→	238	 29	Light switch	→	141



10 At a glance - Cockpit (plug-in hybrid)

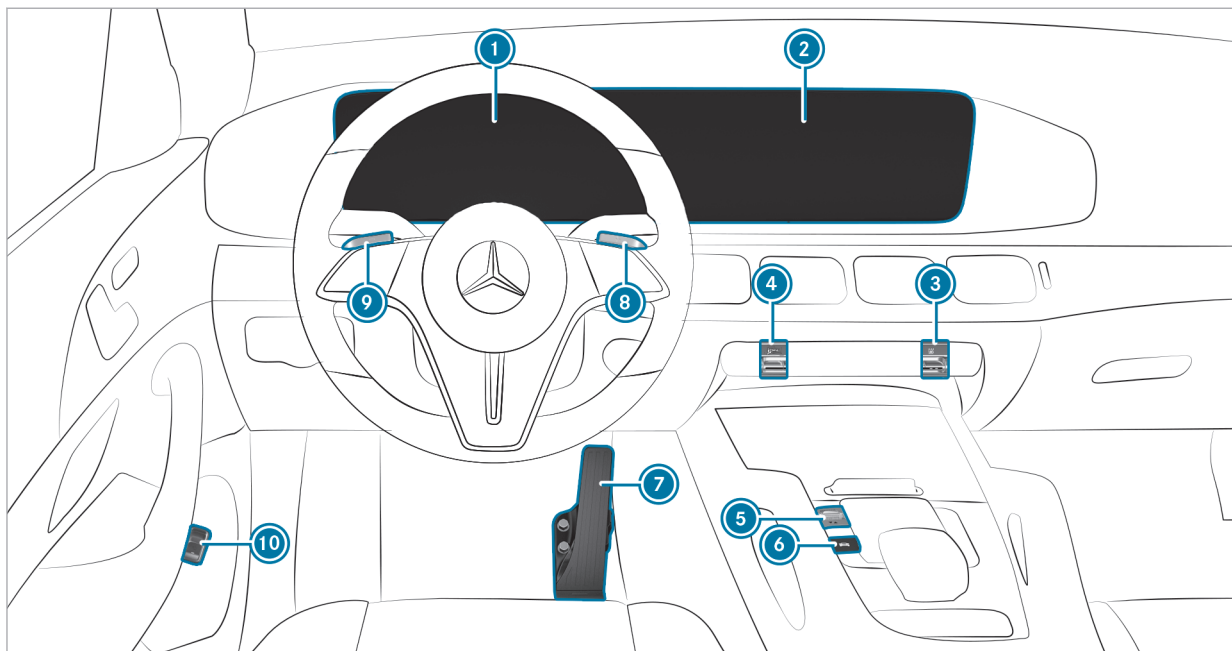







Left-hand drive vehicles

① Driver's display:

 Operational readiness	→	306
Power availability display		
Power meter	→	310
Trip computer		
ECO Assist	→	188

② Central display:







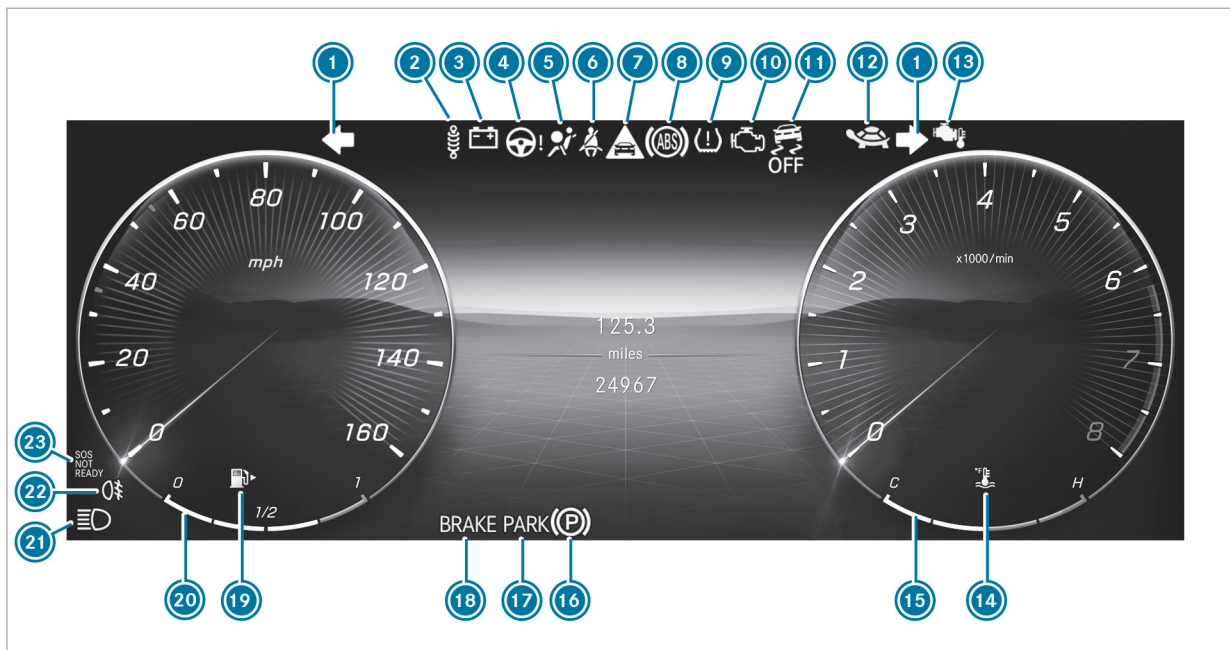





















Plug-in hybrid settings	→	337
Energy flow display	→	338
③  Switches immediate pre-entry climate control on/off	→	165

④  Sets pre-entry climate control for departure time	→	165
⑤ DYNAMIC SELECT switch	→	190
⑥  Calls up the EQ menu	→	337
⑦  Haptic accelerator pedal	→	190
⑧  Reduces recuperation	→	187
⑨  Increases recuperation	→	187
⑩  Depressurizes the fuel tank	→	201

12 At a glance – Indicator and warning lamps



Driver's display

1		Turn signal lights	→	142	14		Coolant temperature	→	541
2		Suspension (red)	→	548	15		Coolant temperature display		
		Suspension (yellow)	→	548	16		Electric parking brake (yellow)	→	545
3		Electrical malfunction	→	541	17		Electric parking brake (red)	→	545
4		Power steering (red)	→	540			USA only		
		Power steering (yellow)	→	540			Canada only		
5		Restraint system	→	538	18		Brakes (red)	→	545
6		Seat belt	→	538			USA only		
7		Distance warning	→	548			Canada only		
8		ABS	→	548			Recuperative Brake System, USA only	→	545
9		Tire pressure monitor	→	552			Brakes (yellow), Canada only	→	545
10		Engine diagnostics	→	541	19		Reserve fuel with fuel filler flap location indicator	→	541
11		ESP® OFF	→	548	20		Fuel level		
		ESP®	→	548	21		High beam	→	142
12		Plug-in hybrid: reduced performance	→	539			Low beam	→	141
13		Gasoline engine: reduced power					Standing lights	→	141

14 At a glance - Indicator and warning lamps

22  Rear fog light



142

23 





Mercedes-Benz emergency call system



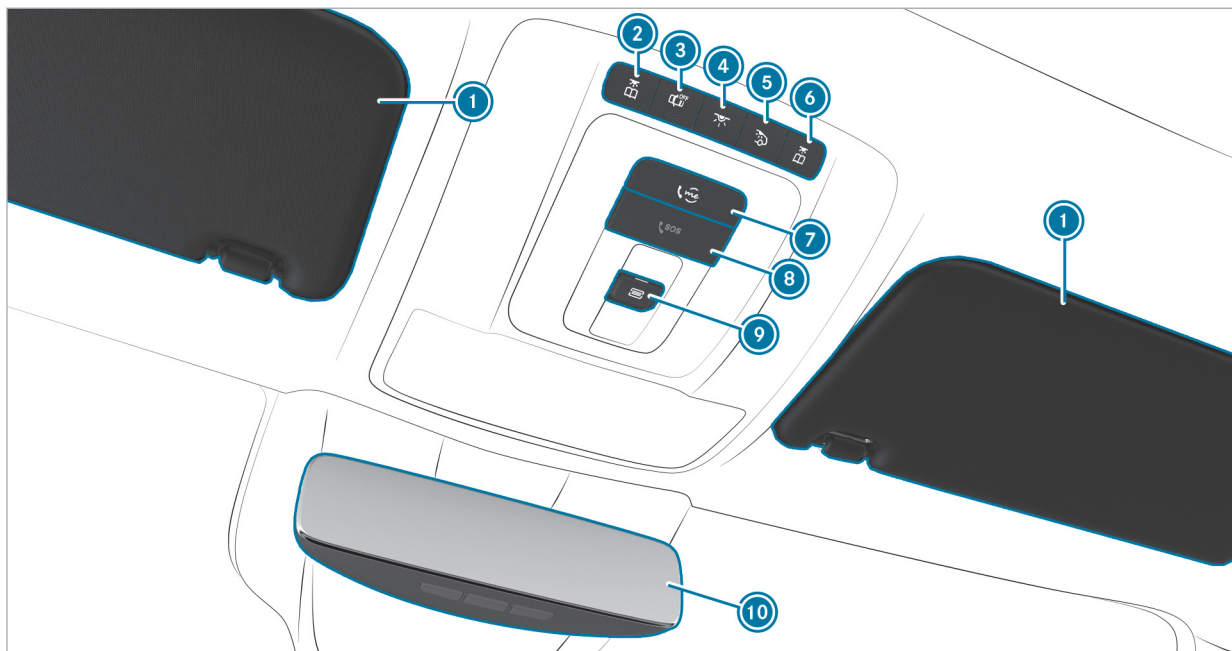



552











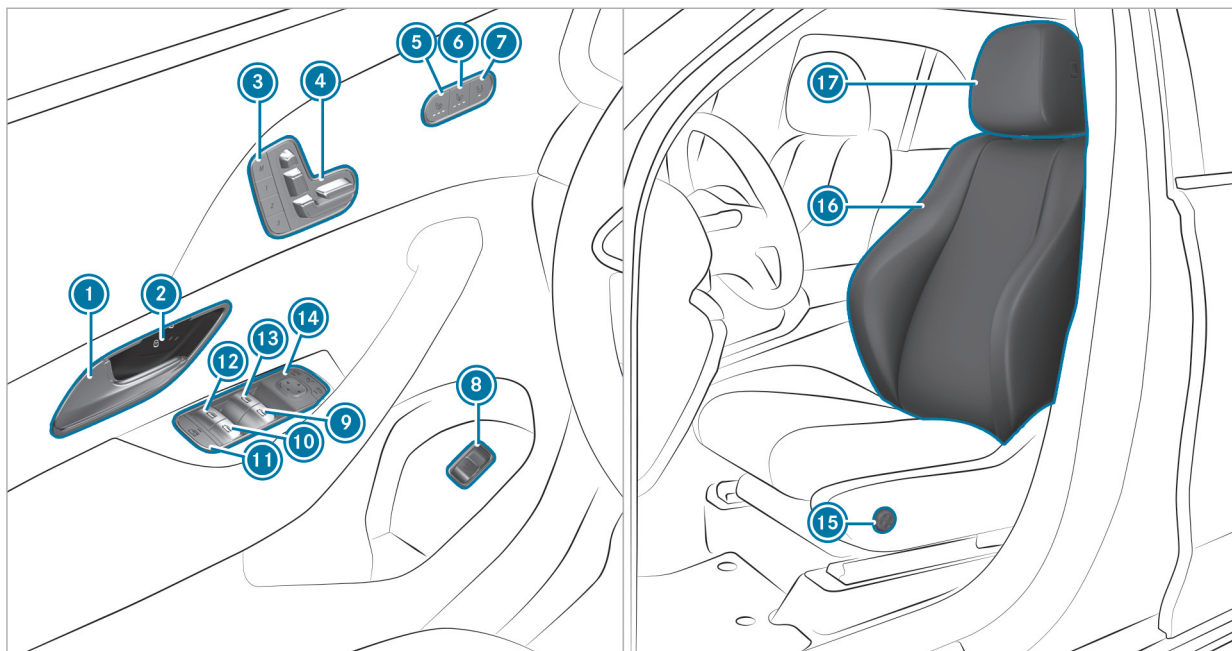







1	Sun visors		
2	 Switches the left-hand reading lamp on/off	→	146
3	 Switches automatic interior lighting control on/off	→	146
4	 Switches the front interior lighting on/off	→	146
5	 Switches the rear interior lighting on/off	→	146
6	 Switches the right-hand reading lamp on/off	→	146

7	 me button	→	353
8	 SOS button	→	353
9	 Opens/closes the panorama roof with power tilt/sliding panel	→	93
	 Opens/closes the roller sunblind	→	93
10	Inside rearview mirror	→	153

18 At a glance – Door operating unit and seat adjustment



①	Opens the door	→	80	⑩	 Opens/closes the rear right side window	→	89
②	  Locks/unlocks the vehicle	→	80	⑪	 Child safety lock for the rear side windows	→	75
③	 Sets the memory function	→	118	⑫	 Opens/closes the rear left side window	→	89
④	Adjusts the seats electrically	→	102	⑬	 Opens/closes the left side window	→	89
⑤	 Switches the seat heating on/off	→	112	⑭	 Operates the outside mirrors	→	152
⑥	 Switches the seat ventilation on/off	→	113	⑮	Adjusts the 4-way lumbar support	→	105
⑦	 Adjusts the front passenger seat from the driver's seat	→	104	⑯	Seat adjustment using the multimedia system	→	111
⑧	 Opens/closes the tailgate	→	84	⑰	Adjusts the head restraints	→	108
⑨	 Opens/closes the right side window	→	89				

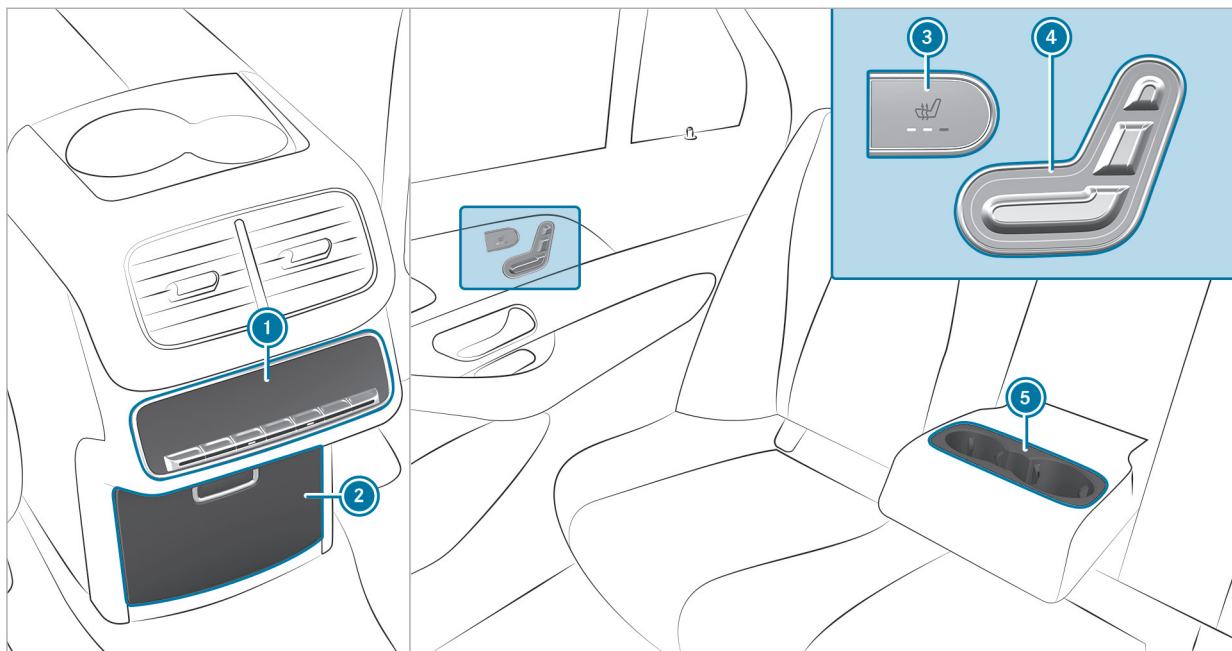

20 At a glance - Control settings in the rear passenger compartment

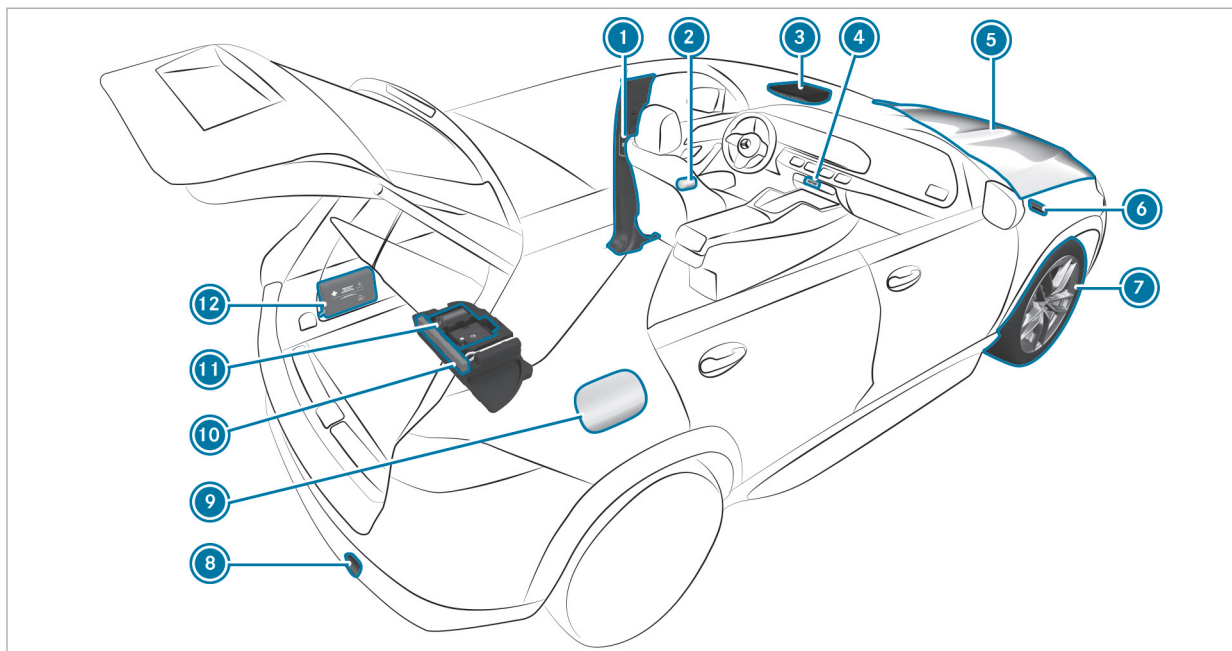

① Rear climate control operating unit	→	158
② Stowage compartment in the center console		
USB charge port	→	137

③  Switches the rear seat heating on/off	→	112
④ Adjusts the rear seat electrically	→	105
⑤ Cup holder		



① B-pillar with: QR code for accessing the rescue card	→	38	⑦ Flat tire	→	390
② Safety vests	→	388	⑧ Tow-starting or towing away	→	406
③  me button	→	353	⑨ Fuel filler flap with: information label on fuel type	→	201
 SOS button	→	353	Information label on tire pressure	→	417
④  Hazard warning light system	→	143	QR code for accessing the rescue card	→	38
⑤ To check and refill operating fluids	→	452	⑩ Warning triangle	→	389
Jump-starting	→	402	⑪ TIREFIT kit	→	393
⑥ Tow-starting or towing away	→	406	⑫ First-aid kit (soft sided)	→	390

Calling up the Digital Operator's Manual

Multimedia system:

→ [Home] ▶ Settings ▶ Info

▶▶ Operator's Manual

▶▶ Open Digital Operator's Manual

The Digital Operator's Manual describes the functions and operation of the vehicle and the multimedia system.

▶ Select one of the following menu items in the Digital Operator's Manual:

- **Quick start:** find the first steps towards adjusting your seat (driver's side).
- **Tips:** find information that prepares you for certain everyday situations with your vehicle.
- **Animations:** watch animations of the vehicle functions.
- **Messages:** receive additional information about the messages in the driver's display.
- **Language:** select the language for the Digital Operator's Manual.

You can search for keywords using the search field **Search**, in order to find quick answers to questions about the operation of the vehicle.

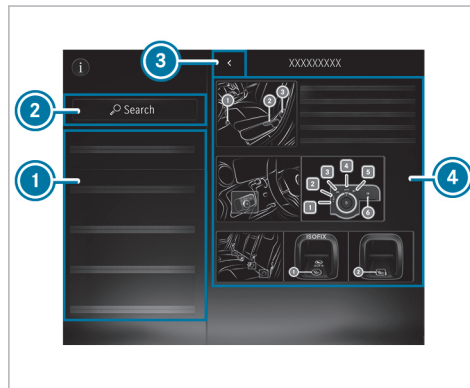

- 1 Menu
- 2 Search
- 3 Back
- 4 Contents section

Some sections in the Digital Operator's Manual, such as warning notes, can be expanded and collapsed.

Additional methods of calling up the Digital Operator's Manual:

Driver's display: call up brief information as display messages in the driver's display

MBUX Voice Assistant: call up via the voice control system

Global search: call up search results for contents of the Digital Operator's Manual in the home screen

For safety reasons, the Digital Operator's Manual is deactivated while driving.

Protecting the environment

 **ENVIRONMENTAL NOTE** Environmental damage due to operating conditions and personal driving style

The pollutant emission of the vehicle is directly related to the way you operate the vehicle.

Operate your vehicle in an environmentally responsible manner to help protect the environment. Please observe the following recommendations on operating conditions and personal driving style.

Operating conditions:

- ▶ Make sure that the tire pressure is correct.
- ▶ Do not carry any unnecessary weight (e.g. roof luggage racks once you no longer need them).
- ▶ Adhere to the service intervals. A regularly serviced vehicle will contribute to environmental protection.

- ▶ Always have maintenance work carried out at a qualified specialist workshop.

Personal driving style:

- ▶ Do not depress the accelerator pedal when starting the engine.
- ▶ Do not warm up the vehicle while stationary.
- ▶ Drive carefully and maintain a suitable distance from the vehicle in front.
- ▶ Avoid frequent, sudden acceleration and braking.
- ▶ Change gear in good time and use each gear only up to $\frac{2}{3}$ of its maximum engine speed.
- ▶ Switch off the vehicle in stationary traffic, e.g. by using the ECO start/stop function.
- ▶ Drive in a fuel-efficient manner. Observe the ECO display for an economical driving style.

Plug-in hybrid

 **ENVIRONMENTAL NOTE** Environmental pollution caused by irresponsible disposal of the high-voltage battery

A high-voltage battery contains materials which are harmful to the environment.

- ▶ Dispose of defective high-voltage batteries at a qualified specialist workshop.

Environmental issues and recommendations:

It is recommended that you re-use or recycle materials instead of just disposing of them.

The relevant environmental guidelines and regulations serve to protect the environment and must be strictly observed.

Mercedes-Benz GenuineParts



ENVIRONMENTAL NOTE Environmental damage due to not using recycled reconditioned components

Mercedes-Benz AG offers recycled reconditioned components and parts with the same quality as new parts. The same entitlement from the Limited Warranty is valid as for new parts.

- ▶ Use recycled reconditioned components and parts from Mercedes-Benz AG.



NOTE Impairment of the operating efficiency of the restraint systems from installing accessory parts or from repairs or welding

Air bags and Emergency Tensioning Devices, as well as control units and sensors for the restraint systems, may be installed in the following areas of your vehicle:

- doors

- door pillars
- sill
- seats
- cockpit
- instrument display
- center console
- lateral roof frame

- ▶ Do not install accessory parts such as audio systems in these areas.
- ▶ Do not carry out repairs or welding.
- ▶ Have accessories retrofitted at a qualified specialist workshop.

You could jeopardize the operating safety of your vehicle if you use parts, tires and wheels as well as accessories relevant to safety that have not been approved by Mercedes-Benz. Safety-critical systems (e.g. the brake system) may malfunction. Use only Mercedes-Benz GenuineParts or parts of equal quality. Use only tires, wheels and accessory parts that have been specifically approved for your vehicle model.

Mercedes-Benz GenuineParts are subject to strict quality inspections. Each part has been specially developed, manufactured or selected for Mercedes-Benz vehicles and adapted to them. Therefore, only Mercedes-Benz GenuineParts should be used.

More than 300,000 different Mercedes-Benz GenuineParts are available for Mercedes-Benz models.

All authorized Mercedes-Benz Service Centers maintain a supply of Mercedes-Benz GenuineParts for necessary service and repair work. In addition, strategically located parts delivery centers provide for quick and reliable parts service.

Always specify the vehicle identification number (VIN) (→ page 450) when ordering Mercedes-Benz GenuineParts.

Operator's Manual

This Operator's Manual and the Digital Operator's Manual in the vehicle describe the following models and the standard and special equipment for your vehicle:

- The models and the standard and special equipment available at the time of this Operator's Manual going to press.
- The models and the standard and special equipment only available in certain countries.
- The models and the standard and special equipment, which will only be available at a later date.

Note that your vehicle may not have all features described. This is also the case for systems relevant to safety. Therefore, the equipment on your vehicle may differ from that in the descriptions and illustrations.

The original purchase agreement for your vehicle contains a list of the equipment in your vehicle at the time of delivery.

Should you have any questions concerning equipment and operation, please consult an authorized Mercedes-Benz Center.

- ⓘ Please bear in mind that all the speed values stated in this Operator's Manual are approximate and are subject to a certain tolerance.

The Operator's Manual, Supplement, further supplementary documents and Maintenance Booklet are important documents and should be kept in the vehicle.

Touch-sensitive controls

In addition to conventional switches and buttons, your vehicle is equipped with touch-sensitive controls.

These are located in the following areas of your vehicle:

- Roof and door control panel
- Climate control
- Steering wheel
- MBUX multimedia system

The controls have touch-sensitive user interface surfaces. The surfaces are controlled by pressing or swiping to adjust settings or to trigger functions, for example.

In the area of the touchscreen, you also receive haptic feedback in the form of a pulse or a vibration, or the surface structure changes on the touch-sensitive user interface surface, for example.

You receive haptic feedback in the following situations, for example:

- When pressing a button on the user interface surface
- When scrolling in a list or table
- When reaching a new area on the user interface surface, e.g. a pop-up window

When handling touch-sensitive user interface surfaces, observe the following points to avoid problems operating:

- Do not affix stickers or similar objects on the surfaces
- Keep the surfaces free of moisture.

- Keep the surfaces free of dust and dirt (→ page 385).

Some touch-sensitive control elements have a symbol and integrated indicator lamps. When operating, make sure to press on the symbol of the control element.

Mercedes me app

Notes about the on-demand feature

You can also activate various functions (on-demand feature) subsequently via Mercedes me after purchasing your vehicle.

Information is available at any authorized Mercedes-Benz Service Center.

Activating on-demand feature using Mercedes me

Requirements

- The vehicle has a wireless connection.
- The vehicle is linked to the Mercedes me user account.

Ordering and activating on-demand feature

- ▶ Add the desired on-demand feature for the vehicle to the shopping basket in the Mercedes me Store.
- ▶ Complete the order.
The on-demand feature is activated when operating the vehicle.

Speeding up activation

- ▶ Switch the vehicle off and lock it.
- ▶ Unlock the vehicle after about two minutes and switch on the vehicle.
The on-demand feature has been activated. For some features, a notification also appears in the vehicle's multimedia system.

If the activation was not successful, repeat the process.

Service and vehicle operation

Vehicle operation outside the USA or Canada

When you are abroad with your vehicle, observe the following points:

- service points or replacement parts may not be available immediately.
- unleaded fuel may not be available for vehicles with a catalytic converter. Leaded fuel may cause damage to the catalytic converter.
- the fuel may have an extremely low octane number. Unsuitable fuel can cause engine damage.

Some Mercedes-Benz models are available in Europe through our European Delivery Program. For more information, please consult an authorized Mercedes-Benz Service Center, or write to one of the following addresses:

in the USA:

Mercedes-Benz USA, LLC
European Delivery Department
One Mercedes-Benz Drive
Sandy Springs, GA 30328

in Canada:

Mercedes-Benz Canada, Inc.
 European Delivery Department
 98 Vanderhoof Avenue
 Toronto, Ontario M4G 4C9

Maintenance

Your customer advisor confirms the service in the service report.

Roadside Assistance

The Mercedes-Benz Roadside Assistance Program offers technical help in the case of a breakdown. Your calls to the toll-free Roadside Assistance Hotline are answered by our agents 24 hours a day, 365 days a year.

1-800-FOR-MERCEdes (1-800-367-6372) (USA)
 1-800-387-0100 (Canada)

You can find further information in the Mercedes-Benz Roadside Assistance Program brochure (USA) or the "Roadside Assistance" section in the

Service and Warranty booklet (Canada). You will find both in the vehicle document wallet.

Change of address or change of ownership

In the event of a change of address, please send us the "Notification of address change" in the Service and Guarantee booklet or simply call the Mercedes-Benz Customer Assistance Center (USA) on the hotline number 1-800-FOR-MERCEdes (1-800-367-6372) or Customer Service (Canada) on 1-800-387-0100. We can then reach you in a timely fashion, if necessary.

If you sell your Mercedes, please leave all literature in the vehicle so that it is available to the next owner. If you have purchased a used vehicle, please send us the "Notice of Purchase of Used Car" in the Service and Guarantee booklet or simply call the Mercedes-Benz Customer Assistance Center (USA) at the hotline number 1-800-FOR-MERCEdes (1-800-367-6372) or Customer Service (Canada) at 1-800-387-0100.

Possible danger due to substances hazardous to health

In compliance with Proposition 65 ("Prop65"), the following detachable label has been added to each vehicle sold in California:

**Operating safety**

⚠ WARNING Risk of accident due to malfunctions or system failures

If you do not have the prescribed service/maintenance work or any required repairs car-

ried out, this could result in malfunctions or system failures.

- ▶ Always have the prescribed service and maintenance work or any required repairs carried out in a qualified specialist workshop.

⚠ WARNING Risk of accident or injury due to incorrect modifications on electronic component parts

Modification of electronic components, their software or wiring could impair their function and/or the function of other networked component parts or safety-relevant systems.

This can endanger the operating safety of the vehicle.

- ▶ Never tamper with the wiring and electronic component parts or their software.
- ▶ You should have all work on electrical and electronic components carried out at a qualified specialist workshop.

Observe the "On-board electronics" section in "Technical data".

⚠ WARNING Risk of fire caused by flammable material on hot exhaust system components

Flammable material such as leaves, grass or twigs may ignite if they come into contact with hot parts of the exhaust system.

- ▶ When driving on an unpaved road or off-road, check the vehicle underside regularly.
- ▶ In particular, remove trapped plant parts or other flammable material.
- ▶ If there is damage, consult a qualified specialist workshop immediately.

! NOTE Damage to the vehicle due to driving too fast and due to impacts to the vehicle underbody or suspension components

In the following situations, in particular, there is a risk of damage to the vehicle:

- The vehicle becomes grounded, e.g. on a high curb or an unpaved road
- The vehicle is driven too fast over an obstacle, e.g. a curb, speed bump or pothole
- A heavy object strikes the underbody or suspension components

In situations such as these, damage to the body, underbody, suspension components, wheels or tires may not be visible. Components damaged in this way can unexpectedly fail or, in the case of an accident, may no longer absorb the resulting force as intended.

If the underbody paneling is damaged, flammable materials such as leaves, grass or twigs can collect between the underbody and the

underbody paneling. These materials may ignite if they come into contact with hot parts of the exhaust system.

- ▶ Have the vehicle checked and repaired immediately at a qualified specialist workshop.

or

- ▶ If driving safety is impaired while continuing your journey, pull over and stop the vehicle immediately, while paying attention to road and traffic conditions, and contact a qualified specialist workshop.

Plug-in hybrid

Hybrid vehicles have an internal-combustion engine and at least one electric motor. The energy supply for operating the vehicle electrically is provided by the high-voltage on-board electrical system.

⚠ DANGER Risk of death and fire due to modified and/or damaged components of the high-voltage on-board electrical system

The vehicle's high-voltage on-board electrical system is under high voltage. If you modify component parts in the vehicle's high-voltage on-board electrical system or touch damaged component parts, you may be electrocuted. In addition, modified and/or damaged components may cause a fire.

In the event of an accident or impact to the vehicle underbody, components of the high-voltage electrical system may be damaged although the damage is not visible.

- ▶ Never make any modifications to the high-voltage on-board electrical system.
- ▶ Do not switch on or use the vehicle if its high-voltage on-board electrical system components have been modified or damaged.

- ▶ Never touch damaged components of the high-voltage on-board electrical system.
- ▶ After an accident, do not touch any components of the high-voltage on-board electrical system.
- ▶ After an accident, have the vehicle transported away.
- ▶ Have the components of the high-voltage on-board electrical system checked at a qualified specialist workshop and replaced if necessary.

The components of the vehicle's high-voltage on-board electrical system are marked with yellow warning stickers. The cables of the high-voltage on-board electrical system are orange.

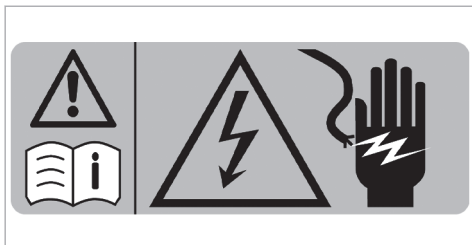

High-voltage components that can become very hot are marked with an additional warning sticker:



Example

Vehicles with hybrid systems generate significantly less noise when stationary and when being driven than vehicles with internal-combustion engines.

When you are driving in electric mode, the vehicle may not be heard by other road users due to the significantly lower noise generated when driving and when stationary.-

For this reason, the vehicle is equipped with a sound generator, which serves as an acoustic vehicle alerting system (AVAS). This protective equipment is prescribed by law.

The outside sound produced by the sound generator (AVAS) can be heard in the passenger compartment at low speeds and does not represent a malfunction.

Vehicles with a 48 V on-board electrical system

⚠ DANGER Risk of fatal injury by touching damaged high-voltage components

Vehicles with a 48 V on-board electrical system contain individual high-voltage components. These high-voltage components are under high voltage.

If you modify component parts of these high-voltage components or touch damaged component parts, you may be electrocuted.

High voltage components may be damaged in an accident, although the damage may not be visible.

- ▶ Never perform modifications to component parts of high-voltage components.
- ▶ Never touch damaged component parts of high-voltage components.
- ▶ Never touch component parts of high-voltage components after an accident.

Vehicles with a 48 V on-board electrical system contain high-voltage components. These components are marked with a high-voltage label:

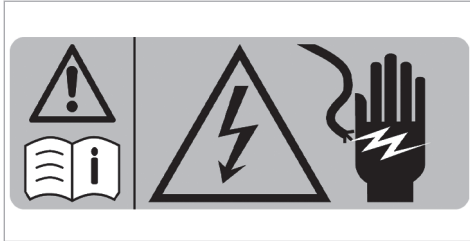

All work on high-voltage components must be carried out at a qualified specialist workshop.

Notes on assembling the license plate on the front license plate holder

! **NOTE** Malfunctions and system failures due to incorrect mounting of the license plate on the front license plate holder

If the license plate is incorrectly mounted on the front license plate holder, sensors, cameras or driving and safety systems may malfunction or fail.

Observe the following points when mounting the license plate on the front license plate holder:

- ▶ Mount the license plate directly on the license plate holder without advertising media or other holders.
- ▶ Mount the license plate so that it does not protrude above or to the side of the license plate adapter.

National information for components relevant to radio regulation

Information on crossing national borders

You must observe the radio regulations for the country in which you are currently operating your vehicle.



USA: "Radio based devices of this vehicle comply with Part 15 of the FCC Rules. Operation is subject to the following two conditions: 1) These devi-

ces may not cause harmful interference, and 2) These devices must accept any interference received, including interference that may cause undesired operation. Changes or modifications not expressly approved by the party responsible for compliance could void the user's authority to operate the equipment."

Canada: "This vehicle contains licence-exempt transmitter(s)/receiver(s) that comply with Innovation, Science and Economic Development Canada's licence-exempt RSS(s). Operation is subject to the following two conditions: (1) These devices may not cause interference. (2) These devices must accept any interference, including interference that may cause undesired operation of the devices." "Les émetteurs/récepteurs dans cette véhicule sont conforme aux CNR d'Innovation, Sciences et Développement économique Canada applicables aux appareils radio exempts de licence. L'exploitation est autorisée aux deux conditions suivantes : 1) Ces appareils ne doivent pas produire de brouillage; 2) Ces appareils doivent accepter tout brouillage radioélectrique subi, même si le brouillage est susceptible d'en compromettre le fonctionnement."

Diagnostics connection

The diagnostics connection is a technical interface in the vehicle. It is used, for example, during repair and maintenance work or for reading out vehicle data in a specialist workshop. Diagnostic devices should therefore only be connected in a qualified specialist workshop.

⚠ WARNING Risk of accident due to connecting devices to the diagnostics connection

If you connect devices to the diagnostics connection of the vehicle, the function of vehicle systems and operating safety may be impaired.

- ▶ For safety reasons, we recommend that you use and connect only products approved by an authorized Mercedes-Benz Service Center.

⚠ WARNING Risk of accident due to objects in the driver's footwell

Objects in the driver's footwell may impede pedal travel or block a depressed pedal.

This jeopardizes the operating and road safety of the vehicle.

- ▶ Stow all objects in the vehicle securely so that they cannot get into the driver's footwell.
- ▶ Always install the floor mats securely and as prescribed in order to ensure that there is always sufficient room for the pedals.
- ▶ Do not use loose floor mats and do not place floor mats on top of one another.

! NOTE Battery discharging from using devices connected to the diagnostics connection

Using devices at the diagnostics connection drains the battery.

- ▶ Check the charge level of the battery.

- ▶ If the charge level is low, charge the battery, e.g. by driving a considerable distance.

Please also note the information about the 12 V battery and short-distance trips in the "Driving and Parking" chapter (→ page 176).

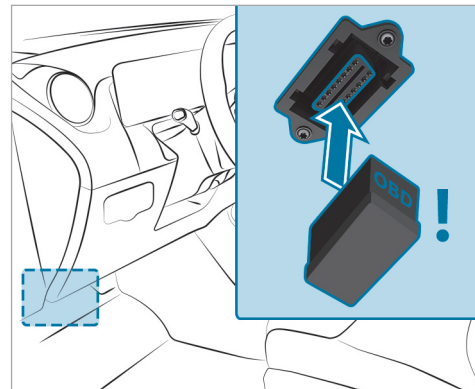

Connecting and using another device with the diagnostics connection can have the following effects:

- Malfunctions in the vehicle system
- Permanent damage to vehicle components

Please refer to the warranty terms and conditions for this matter.

Moreover, connecting equipment to the diagnostics connection can lead to emissions monitoring information being reset, for example. This may lead to the vehicle failing to meet the requirements of the next emissions inspection during the main inspection.

Qualified specialist workshop

An authorized Mercedes-Benz Service Center is a qualified specialist workshop. It has the necessary special skills, tools and qualifications to correctly carry out the work required on your vehicle. This particularly applies to safety-relevant work.

For the following, always have your vehicle checked at an authorized Mercedes-Benz Service Center:

- Safety-relevant work
- Service and maintenance work
- Repair work
- Modifications as well as installations and conversions
- Work on electronic components
- **Plug-in hybrid:** work on the hybrid system
- **Vehicles with 48 V on-board electrical system:** work on the high-voltage component of the 48 V on-board electrical system

Mercedes-Benz recommends a Mercedes-Benz Service Center.

Correct use of the vehicle

If you remove any warning stickers, you or others could fail to recognize certain dangers. Leave warning stickers in position.

Observe the following information in particular when driving your vehicle:

- the safety notes in this Operator's Manual, vehicle-specific supplements and further supplementary documents
- technical data for the vehicle
- traffic laws and regulations of the country you are currently driving in
- laws pertaining to motor vehicles and safety standards of the country you are currently driving in
- radio regulatory requirements of the country you are currently driving in

Sport Utility Vehicle

⚠ WARNING Risk of accident when the center of gravity is too high

The vehicle may start to skid and rollover in the event of sudden steering maneuvers and/or when the vehicle's speed is not adapted to the road conditions.

- ▶ Always adapt your speed and driving style to the vehicle's driving characteristics and to the prevailing road and weather conditions.

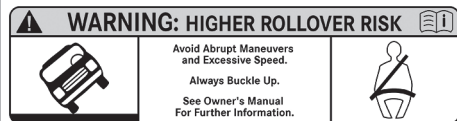

USA

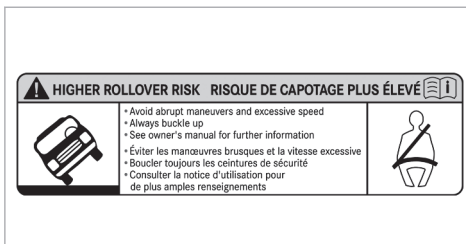

Canada

Utility vehicles have a significantly higher rollover rate than other types of vehicles.

If this type of vehicle is not driven safely, an accident can occur, the vehicle can roll over and occupants can suffer serious or even fatal injuries.

In a rollover crash, an unbelted person is significantly more likely to die than a person wearing a seat belt.

You and all vehicle occupants should always wear your seat belts.

Notes for persons with electronic medical aids

Mercedes-Benz AG cannot, despite carefully developing vehicle systems, completely rule out the interaction of vehicle systems with electronic medical aids such as cardiac pacemakers.

In addition, there are components installed in the vehicle that, regardless of the operating status of the vehicle, can generate magnetic fields on a par with permanent magnets. These fields can be found, for example, in the area around the multimedia and sound system or also in the area of the seats, depending on the vehicle equipment.

For this reason, the following can occur in isolated cases, depending on the aids used:

- Medical aids malfunctioning
- Adverse health effects

Observe the notes and warnings of the manufacturer of the medical aids; if in doubt, contact the device manufacturer and/or your doctor. If there is continuing uncertainty concerning the possibility of medical aids malfunctioning, Mercedes-Benz AG recommends using only few electrical

vehicle systems and/or maintaining a distance from the components.

Plug-in hybrid

When charging the high-voltage battery, keep a distance of at least an arm's length between the medical aid and the following components:

- The power supply equipment
This includes charging stations in the form of a wallbox or a public charging point, for example.
- Vehicle components carrying live voltage
This includes the charging cable and the charging control box, for example.

Only have repairs and maintenance work in the area of the following components carried out at a qualified specialist workshop:

- Vehicle components carrying live voltage
- Transmission antenna
- Multimedia system and sound system

If you have any queries or suggestions, consult a qualified specialist workshop.

Problems with your vehicle

If you should experience a problem with your vehicle, particularly one that you believe may affect its safe operation, we urge you to contact an authorized Mercedes-Benz Center immediately to have the problem diagnosed and rectified. If the problem is not resolved to your satisfaction, please discuss the problem again with an authorized Mercedes-Benz Center or, if necessary, contact us at one of the following addresses:

In the USA:

Mercedes-Benz USA, LLC
Customer Assistance Center
One Mercedes-Benz Drive
Sandy Springs, GA 30328

In Canada:

Mercedes-Benz Canada, Inc.
Customer Relations Department
98 Vanderhoof Avenue
Toronto, Ontario M4G 4C9

Reporting safety defects

USA only:

The following text is published as required of manufacturers under Title 49, Code of U.S. Federal Regulations, Part 575 pursuant to the "National Traffic and Motor Vehicle Safety Act of 1966".

If you believe that your vehicle has a defect which could cause a crash or could cause injury or death, you should immediately inform the National Highway Traffic Safety Administration (NHTSA) in addition to notifying Mercedes-Benz USA, LLC.

If NHTSA receives similar complaints, it may open an investigation, and if it finds that a safety defect exists in a group of vehicles, it may order a recall and remedy campaign. However, NHTSA cannot become involved in individual problems between you, your dealer, or Mercedes-Benz USA, LLC.

To contact NHTSA, you may call the Vehicle Safety Hotline toll-free at 1-888-327-4236 (TTY: 1-800-424-9153) ; go to <https://www.safercar.gov>; or write to: Administrator, NHTSA, 400 Seventh Street, SW., Washington, DC 20590, USA.

You can also obtain other information about motor vehicle safety from <https://www.safercar.gov>.

Canada only:

The following text is published as required of manufacturers under subsection 18.4 (4) of the Motor Vehicle Safety Regulations.

If you believe that your vehicle has a defect which could cause a crash or could cause injury or death, you should immediately inform Transport Canada in addition to notifying Mercedes-Benz Canada Inc.

If Transport Canada received similar complaints, it may open an investigation, and if it finds that a safety defect exists in a group of vehicles, it may order a recall and remedy campaign. However, Transport Canada cannot become involved in individual problems between you, your dealer, or Mercedes-Benz Canada Inc.

To contact Transport Canada, you may call the Defect Investigations and Recalls Division toll-free in Canada at 1-800-333-0510 or 819-994-3328 in the Gatineau-Ottawa area or internationally; may also go to the following websites for more information:

- English: <https://www.tc.gc.ca/recalls>
- French: <https://www.tc.gc.ca/rappels>

Limited Warranty

! **NOTE** Damage to the vehicle arising from violation of these operating instructions.

Damage to the vehicle can arise from violation of these operating instructions.

This damage is not covered either by the Mercedes-Benz implied warranty or by the New- or Used-Vehicle Warranty.

▶ Follow the instructions in these operating instructions on proper operation of your vehicle as well as on possible vehicle damage.

QR code for rescue card

QR codes are attached in the fuel filler flap and on the opposite side on the B-pillar. In the event of an accident, rescue services can use the QR code to quickly find the appropriate rescue card for

your vehicle. The current rescue card contains the most important information about your vehicle (e.g. the routing of the electric lines) in compact form.

Further information can be obtained at <https://www.mercedes-benz.de/qrcode>

Data storage

Data processing in the vehicle

Electronic control units

Your vehicle is installed with electronic control units. Control units process data that they e.g. receive from vehicle sensors, generate themselves or exchange among themselves. Some control units are required for the safe operation of your vehicle, some assist you when driving (e.g. driver assistance systems), while others enable convenience or infotainment functions.

In the following, you will find general information about data processing in the vehicle. Additional information on what specific data is collected, stored and transmitted to third parties for what purpose in your vehicle can be found in the notes

on the functional features in question in the respective operating instructions. These are also available online and, depending on the equipment, digitally in the vehicle.

Personal data

Each vehicle is marked with a unique vehicle identification number. Depending on the country, this vehicle identification number can be used by, for example, government authorities to determine the identity of the owner. There are other possibilities for using data collected from the vehicle to identify the owner or driver (e.g. the license plate number).

The data generated or processed by control units may therefore be personal or, under certain conditions, become personal. Depending on what vehicle data is available, it may be possible to make inferences about e.g. your driving behavior, location, route or use patterns.

Legal requirements for the disclosure of data

If legal regulations exist, manufacturers are generally obligated to release data stored by the manufacturer to the necessary extent in individual cases at the request of state authorities. This may

be the case during the investigation of a criminal offense, for example.

Within the framework of applicable law, state authorities are also authorized to read out data from vehicles themselves in specific cases. In the event of an accident, for example, information can be read from the air bag control unit that can help to establish what happened.

Operating data in the vehicle

Control units process data to operate the vehicle.

This includes the following data:

- Vehicle status information such as the speed, longitudinal acceleration, lateral acceleration, number of wheel revolutions or the fastened seat belts display
- Ambient conditions such as temperature, rain sensor or distance sensor

As a rule, this data is volatile, is not stored beyond the operating time and is processed only in the vehicle itself. Control units (e.g. the vehicle key) often contain data memories. These are used to temporarily or permanently document information on the vehicle condition, component stress, main-

tenance requirements or technical events and malfunctions.

Depending on the technical equipment, the following data is stored:

- Operating status of system components (e.g. fill levels, tire pressure, battery status)
- Malfunctions or faults in important system components (e.g. lights, brakes)
- System reactions in special driving situations (e.g. air bag deployment, the intervention of stability control systems)
- information on events leading to vehicle damage

In special cases, it may be necessary to store data that would otherwise only be volatile. This may be the case if the vehicle has detected a malfunction, for example.

If you use services such as repair services or maintenance work, stored operational data can be read out and used together with the vehicle identification number, where necessary. It can be read out by service network employees (e.g. workshops and manufacturers) or third parties (e.g.

breakdown services). The same applies to warranty cases and quality assurance measures.

The data is usually read out via the diagnostics connection in the vehicle, which is required by law. The operating data that is read out documents technical conditions of the vehicle or individual components and helps to diagnose malfunctions, meet warranty obligations and improve quality. This data, in particular information on component stress, technical events, operating errors and other malfunctions, is transmitted to the manufacturer for this purpose together with the vehicle identification number if necessary. In addition, the manufacturer is subject to product liability. For this reason, the manufacturer also uses operational data from the vehicle for e.g. recalls. This data can also be used to check customer claims for warranty and guarantee.

Malfunction memories in the vehicle can be reset during repair or service work or, at your request, by a service company.

Comfort and infotainment functions

You can save comfort settings and customizations in the vehicle and change or reset them at any time.

Depending on the vehicle equipment, this includes the following settings:

- Seat positions and steering wheel positions
- Suspension tuning and climate control settings
- Personalized settings (e.g. interior lighting)

You can incorporate data into the vehicle's infotainment functions yourself as part of the selected equipment.

Depending on the vehicle equipment, this includes the following data:

- Multimedia data (e.g. music, films or photos for playback in an integrated multimedia system)
- Address book data for use in conjunction with an integrated hands-free system or integrated navigation system
- Navigation destinations that have been entered

- Data about using Internet services

This data for comfort and infotainment functions can be saved locally in the vehicle or is stored on a device that you have connected to the vehicle (e.g. smartphone, USB flash drive or MP3 player). If you have entered data yourself, you can delete it at any time.

The transfer of this data out of the vehicle takes place exclusively at your request. This applies in particular when you are using online services according to the settings you have selected.

Smartphone integration (e.g. Android Auto or Apple CarPlay®)

If your vehicle is equipped appropriately, you can connect your smartphone or another mobile end device to the vehicle. You can then control them using the controls integrated in the vehicle. The smartphone's picture and sound can be output via the multimedia system. Specific items of information are also sent to your smartphone.

Depending on the type of integration, this includes position data, day/night mode and other general vehicle statuses. Please refer to the vehi-

cle Operator's Manual / infotainment system operating instructions for further information.

This integration allows the use of selected smartphone apps (e.g. navigation apps, music player apps). No additional interaction – in particular active access to vehicle data – takes place between the smartphone and vehicle. The type of additional data processing is determined by the provider of the app being used. Whether you can configure settings for it and, if so, which ones, depend on the app and your smartphone's operating system.

Online services

Wireless network connection

If your vehicle has a wireless network connection, it enables data to be exchanged between your vehicle and additional systems. The wireless network connection is made possible by the vehicle's own transmitter and receiver or by a mobile end device that you have brought into the vehicle, for example, a smartphone. Online functions can be used via the wireless network connection. This includes online services and applications/apps

provided to you by the manufacturer or by other providers.

Manufacturer's services

Regarding the manufacturer's online services, the individual functions are described by the manufacturer in a suitable place, for example, in the Operator's Manual or on the manufacturer's website, where the relevant data protection information is also given. Personal data may be used for the provision of online services. Data is exchanged via a secure connection, such as the manufacturer's designated IT systems. Any personal data which is collected, processed and used, other than for the provision of services, is done so exclusively on the basis of legal permission. This is the case, for example, for a legally prescribed emergency call system, a contractual agreement or when consent has been given.

You can have services and functions, some of which are subject to a fee, activated or deactivated. This excludes legally prescribed functions and services, such as an emergency call system.

Third-party services

If you use online services from other providers (third parties), these services are the responsibility of the provider in question and subject to that provider's data protection conditions and terms of use. As a general rule, the manufacturer has no influence on the content exchanged.

For this reason, when services are provided by third parties, please ask the service provider in question for information about the type, extent and purpose of the collection and use of personal data.

Data protection rights

Depending on your country or the equipment and range of functions of your vehicle as well as the services you use and the services on offer, you are entitled to different data protection rights. Further information on data protection and your data protection rights can either be found on the manufacturer's website or you will receive this information as part of the various services and service offers. There you will also find the contact

information for the manufacturer and its data protection officers.

At a workshop, for example, with the support of a specialist and possibly for a fee, you can have data read out which is stored only locally in the vehicle.

MBUX multimedia system/Mercedes me connect

If the vehicle is equipped with the MBUX multimedia system or Mercedes me connect, additional data about the vehicle's operation, the use of the vehicle in certain situations, and the location of the vehicle may be compiled by the MBUX multimedia system or Mercedes me connect.

For additional information, please refer to the "MBUX multimedia system" section and/or the Mercedes me connect Terms and Conditions.

Event data recorder

USA only:

This vehicle is equipped with an event data recorder (EDR). The main purpose of an EDR is to record, in certain crash or near crash-like situa-

tions, such as an air bag deployment or hitting a road obstacle, data that will assist in understanding how a vehicle's systems performed. The EDR is designed to record data related to vehicle dynamics and safety systems for a short period of time, typically 30 seconds or less.

The EDR in this vehicle is designed to record such data as:

- How various systems in your vehicle were operating;
- Whether or not the driver and passenger safety belts were buckled/fastened;
- How far (if at all) the driver was depressing the accelerator and/or brake pedal; and,
- How fast the vehicle was traveling.

These data can help provide a better understanding of the circumstances in which crashes and injuries occur. NOTE: EDR data are recorded by your vehicle only if a non-trivial crash situation occurs; no data are recorded by the EDR under normal driving conditions and no personal data (e.g., name, gender, age, and crash location) are recorded. However, other parties, such as law enforcement could combine the EDR data with

the type of personally identifying data routinely acquired during a crash investigation.

To read data recorded by an EDR, special equipment is required, and access to the vehicle or the EDR is needed. In addition to the vehicle manufacturer, other parties, such as law enforcement, that have the special equipment, can read the information if they have access to the vehicle or the EDR.

EDR data may be used in civil and criminal matters as a tool in accident reconstruction, accident claims, and vehicle safety. Since the Crash Data Retrieval CDR tool that is used to extract data from the EDR is commercially available, Mercedes-Benz USA, LLC („MBUSA“) expressly disclaims any and all liability arising from the extraction of this information by unauthorized Mercedes-Benz personnel.

MBUSA will not share EDR data with others without the consent of the vehicle owners or, if the vehicle is leased, without the consent of the lessee. Exceptions to this representation include responses to subpoenas by law enforcement; by federal, state or local government; in connection with or arising out of litigation involving MBUSA or

its subsidiaries and affiliates; or, as required by law.

Warning: The EDR is a component of the Restraint System Module. Tampering with, altering, modifying or removing the EDR component may result in a malfunction of the Restraint System Module and other systems.

State laws or regulations regarding EDRs that conflict with federal regulation are pre-empted. This means that in the event of such conflict, the federal regulation governs. As of Dec 2016, 17 states have enacted laws relating to EDRs.

Copyright

Free and open source software

Information on licenses for free and open-source software used in your vehicle can be found on the data carrier in your vehicle document wallet and with updates on the following website:

<https://www.mercedes-benz.com/opensource>



Registered trademarks

- Bluetooth® is a registered trademark of Bluetooth SIG, Inc.
- DTS™ is a registered trademark of DTS, Inc.
- Dolby® and MLP™ are registered trademarks of DOLBY Laboratories.
- ESP® and PRE-SAFE® are registered trademarks of Mercedes-Benz Group AG.
- HomeLink® is a registered trademark of Genex Corporation.
- iPod® and iTunes® are registered trademarks of Apple Inc.
- Burmester® is a registered trademark of Burmester Audiosysteme GmbH.
- Microsoft® and Windows Media® are registered trademarks of Microsoft Corporation.
- SIRIUS® is a registered trademark of Sirius XM Radio Inc.
- HD Radio™ is a registered trademark of iBiquity Digital Corporation.
- Gracenote® is a registered trademark of Gracenote, Inc.
- ZAGAT Survey® and related brands are registered trademarks of Zagat Survey, LLC.

Brief overview of the most important points

Basic information

Make sure that the following prerequisites in particular have been met so that the components of the restraint system are able to provide the intended level of protection:

- Sit correctly (→ page 45).
- Fasten the seat belt correctly (→ page 46).
 - Function of the seat belt warning lamp  (→ page 48).
 - Function of the rear seat belt status display (→ page 49).
- The restraint system warning lamp  is not lit up after the self-test (→ page 47).
- The PASSENGER AIR BAG indicator lamps display the correct status of the front passenger air bag (→ page 49).

For clear understanding

The chapter "Occupant safety" includes information on equipment, functions and behaviors that contribute directly to safety of vehicle occupants.

The information is structured as follows:

- **The most important information in brief:** in this chapter, you are provided with an overview of the relationship between the restraint system and the correct behavior of all vehicle occupants.
- **Specific information:** in further sections of the chapter "Occupant safety", you can find specific information on the equipment and functions of the restraint system.
- **Keyword directory:** you can also find certain subjects in this Operator's Manual using the keyword directory.

Information on the following subjects, among others, are not provided in the chapter "Occupant safety":

- Children in the vehicle (→ page 61)
- Driving and driving safety systems (→ page 228)
- Stowage areas (→ page 119)

Defining generic terms clearly

In this Operator's Manual, the following generic terms are used:

- **Occupant safety:** comprises the components and system functions which help to minimize, as much as possible, the stresses on and consequences for vehicle occupants during an accident.
- **Restraint system:** comprises those components which, along with the vehicle structure, help prevent vehicle occupants from potentially coming into contact with parts of the vehicle interior. The seat belts and air bags, for example, are components of the restraint system.
- **Child restraint system:** you can find all information on this subject in the chapter "Children in the vehicle" (→ page 61).

Be diligent

For the components of the restraint system to provide the intended level of protection, it is essential that the sitting posture is correct and that the seat belt is correctly fastened.

Note that negligence when adjusting your sitting posture and fastening the seat belt may have serious consequences. Be diligent and make sure that all vehicle occupants are sitting correctly and have fastened their seat belts properly before starting every journey.

Information on the correct seat position

The seat position must be correct in order for the components of the restraint system to provide the intended level of protection.

The seat position influences both the protection provided by the seat belt and the additional protection provided by the air bag.

The correct seat position with an almost upright posture and a correctly fastened seat belt also reduce the risk posed by the air bag when it is deployed.

When choosing the seat, take note of the available space. When you are sitting with the right posture in a nearly upright position, your head should not touch the roof.

⚠ WARNING Risk of injury or death due to an incorrect seat position

If you deviate from the correct seat position, the air bag cannot provide its intended protective function.

Each vehicle occupant must make sure of the following.

- ▶ Put the seat in the correct position.
- ▶ Fasten seat belts correctly. Pregnant women must take particular care to ensure that the lap belt never lies across the abdomen.
- ▶ Observe the following information.

In order for the restraint system to provide the intended level of protection, observe the following information:

- Before starting your journey, adjust your seat correctly (→ page 101).

When doing so, make sure you are able to fasten your seat belt correctly. The shoulder belt strap must be routed forward from the seat belt outlet over the center of your shoulder.

- Keep your distance from the air bags, especially the front air bags. Set the driver's seat and front passenger seat as far back as possible while making sure the seat belt is fastened correctly.
- If persons are sitting on the rear seats, vehicle occupants should maintain a sufficient distance to the parts of the vehicle interior in front of them.
- Make sure there are no people, animals or objects between the vehicle occupants and an air bag.
- If you are the driver, observe the following information on the correct position of the driver's seat (→ page 101).

Hold the steering wheel only by the steering wheel rim. This allows the driver's air bag to fully deploy.

- Assume a nearly upright position, with your buttocks as far back as possible in the gap between the seat cushion and seat backrest.

This ensures that your back lies as flat and firmly as possible against the seat backrest.

- While driving, do not lean forward and do not lean against the door or side window. You may otherwise be in the deployment area of the air bags.
- Sit with your feet resting on the floor, if possible. Your thighs are slightly supported by the seat cushion

Do not put your feet up on the cockpit, for example. Your feet may otherwise be in the deployment area of the air bag.

- Fasten the seat belt correctly.

Notes on wearing the seat belt correctly

Always fasten your seat belt correctly before starting a journey. A seat belt can provide the best level of protection only if it is worn correctly.

⚠ WARNING Risk of injury or death due to incorrectly fastened seat belt

If the seat belt is not worn correctly, it cannot perform its intended protective function.

In addition, an incorrectly fastened seat belt can also cause injuries, for example, in the event of an accident or when braking or changing direction suddenly.

- ▶ Always ensure that all vehicle occupants have their seat belts fastened correctly and are sitting properly.

⚠ WARNING Risk of injury or death when additional restraint systems are not used for persons with a smaller stature

Persons under 5 ft (1.50 m) tall cannot wear the seat belt correctly without a suitable additional restraint system.

- ▶ Always secure persons under 5 ft (1.50 m) tall in a suitable restraint system.

Each vehicle occupant must observe the following notes in particular:

- The seat belt must not be twisted:

- The shoulder belt strap must be routed forward from the seat belt outlet over the center of your shoulder.
- The shoulder belt strap should neither touch your neck nor be routed under your arm or behind your back.
- The lap belt must be routed as low down across the hips as possible.

In addition, push the lap belt down as far as possible across your hips and pull tight with the shoulder belt strap. Never route the lap belt across your abdomen.

Pregnant women must also take particular care with this.

- The shoulder belt strap and lap belt must fit snugly against the body after being tightened.
- Avoid wearing bulky clothing, e.g. a winter coat.
- Never route the seat belt across sharp, pointed, abrasive or fragile objects.
- Only one person should use each seat belt at any one time.

- Never secure objects with a seat belt if the seat belt is also being used by one of the vehicle's occupants.

Also ensure that no objects, e.g. a cushion, are ever placed between a person and the seat.

Fastening and adjusting seat belts

If the seat belt is pulled quickly or sharply, the seat belt retractor locks. The seat belt strap cannot be pulled out any further.

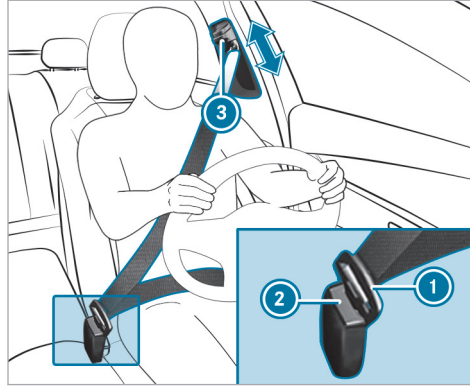

- ▶ Always engage seat belt tongue ① of the seat belt into seat belt buckle ② of the corresponding seat.
- ▶ **To adjust the seat belt height:** press button ③ on the seat belt outlet and slide the seat belt outlet to the desired position.
- ▶ **To engage the seat belt outlet:** release button ③ and ensure that the seat belt outlet engages.

! **NOTE** Deployment of components of the restraint system when the front passenger seat is unoccupied and a seat belt is buckled

When the front passenger seat is unoccupied and the seat belt tongue of the seat belt is engaged in the seat belt buckle, components of the restraint system may deploy unnecessarily on the front passenger side, e.g. the Emergency Tensioning Device.



▶ Only buckle the seat belts as intended.

i Observe the information on child seat safety feature of the seat belt (→ page 69).

Function of the restraint system warning lamp

When the vehicle is switched on, a self-test is performed, during which the restraint system warning lamp  lights up. It goes out no later than a few seconds after the vehicle is started. The components of the restraint system are then functional.

A malfunction has occurred in the restraint system if:

- the restraint system warning lamp  does not light up when the vehicle is switched on
- the restraint system warning lamp  lights up continuously or repeatedly during a journey

If components of the restraint system have been deployed, the restraint system warning lamp  lights up continuously.

⚠ WARNING Risk of injury due to malfunctions in the restraint system

Components in the restraint system may be activated unintentionally or not deploy as planned in an accident.

- ▶ Have the restraint system checked and repaired immediately at a qualified specialist workshop.

Plug-in hybrid vehicles: if the restraint system is malfunctioning, the automatic high voltage emergency shutoff may not function.

⚠ DANGER Risk of fatal injuries due to malfunctions of the automatic high-voltage emergency shutoff

In the event of an accident, the high-voltage on-board electrical system may not be deactivated as intended.

You may be electrocuted if you touch the damaged component parts of the high-voltage on-board electrical system.

- ▶ Have the automatic high-voltage emergency shutoff checked and repaired immediately at a qualified specialist workshop.
- ▶ After an accident, switch off the vehicle immediately.

Mercedes-Benz recommends that you have the vehicle towed to a qualified specialist workshop.

Function of the seat belt warning lamp

The  seat belt warning lamp on the driver's display is a reminder that all vehicle occupants must wear their seat belts correctly.

The  seat belt warning lamp will light up for six seconds every time the vehicle is started.

In addition, a warning tone may sound.

When the driver's and front passengers doors are closed and the driver and front passenger have fastened their seat belts, the seat belt warning will go out.

In the following cases, the seat belt warning will light up during a journey if:

- The driver or front passenger is not wearing a seat belt and the following criteria apply:
 - The vehicle travels at a speed greater than 5 mph (9 km/h) for more than 20 seconds.
 - The vehicle travels at a speed greater than 15 mph (25 km/h) once.
- The driver or front passenger unfastens his/her seat belt while the vehicle is in motion.

Function of the rear seat belt status display

The rear seat belt status display on the driver's display is a reminder that all vehicle occupants must wear their seat belts correctly.

In addition, a warning tone may sound.

If a person unfastens a seat belt in the rear passenger compartment while the vehicle is motion, the rear seat belt status display will appear again.

Indicator on the driver's display

Every time the vehicle is switched on, the rear seat belt status display will provide information for a certain amount of time indicating which rear seat belt is not fastened.

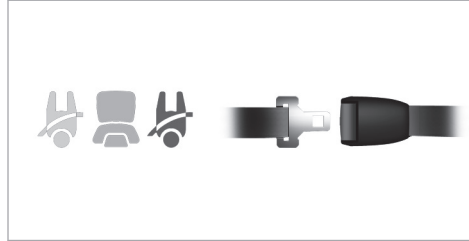

Example: vehicle with three rear seats

You can determine the status of the rear seat belt by the color of the seat symbol on the driver's display as follows:

- Grey: the rear seat belt is not fastened.
- Green: the seat belt tongue of a rear seat belt is engaged in the seat belt buckle of the displayed seat.
- Red: the person in the rear seat has unfastened his/her seatbelt.

Function of the PASSENGER AIR BAG indicator lamps (front passenger air bag)



The PASSENGER AIR BAG indicator lamps display the status of the front passenger air bag.

If the front passenger seat is occupied or a child restraint system is installed on the front passenger seat, you must make sure, both before and during a journey, that the status of the front

passenger air bag is correct for the current situation.

⚠ WARNING Risk of potentially fatal injuries due to objects trapped under the front passenger seat

Objects trapped under the front passenger seat may interfere with the function of the automatic front passenger air bag shutoff or damage the system.

- ▶ Do not stow any objects under the front passenger seat.
- ▶ When the front passenger seat is occupied, ensure that no objects have become trapped beneath the front passenger seat.

Self-test: when the vehicle is switched on, both the PASSENGER AIR BAG ON and OFF indicator lamps light up simultaneously for several seconds. After the self-test, you can determine the status of the front passenger air bag as follows:

- **Front passenger air bag disabled:** PASSENGER AIR BAG OFF lights up continuously.

The front passenger air bag will not be deployed in the event of an accident. If PASSENGER AIR BAG OFF is lit, no one may use the front passenger seat.

If a rearward-facing child restraint system is installed on the front passenger seat, PASSENGER AIR BAG OFF must be lit continuously.

- **Front passenger air bag enabled:** PASSENGER AIR BAG ON lights up for up to 60 seconds or both the PASSENGER AIR BAG ON and OFF indicator lamps do not light up.

The front passenger air bag may be deployed during an accident. If the front passenger air bag has this status, no rearward-facing child restraint system may be installed on the front passenger seat.

- ① If you are driving with a child in the vehicle, observe the information in the chapter "Children in the vehicle" (→ page 61)

⚠ WARNING Risk of injury or death due to a disabled front passenger airbag

The front passenger airbag is disabled when the PASSENGER AIR BAG OFF indicator lamp is lit.

A person in the front passenger seat could then, for example, come into contact with the vehicle interior, especially if the person is sitting too close to the cockpit.

If the front passenger seat is occupied, always ensure that:

- The classification of the person in the front passenger seat is correct and the front passenger airbag is enabled or disabled in accordance with the person in the front passenger seat.
- The front passenger seat has been moved as far back as possible.
- The person is seated correctly.

- ▶ Both before and during the journey, ensure that the status of the front passenger airbag is correct.

Malfunction of the automatic front passenger air bag shutoff

The PASSENGER AIR BAG OFF indicator lamp and the restraint system indicator lamp  light up simultaneously.

In this case, no one may use the front passenger seat and no child restraint system may be installed on the front passenger seat.

Have the automatic front passenger air bag shutoff checked and repaired immediately at a qualified specialist workshop.

Be sure to also observe the following further related subjects:

- Child restraint system on the front passenger seat (→ page 65)

Deactivating or activating the front passenger air bag

The automatic front passenger air bag shutoff can activate or deactivate the front passenger air bag according to the situation.

This happens automatically as a result of the classification of the person or child restraint system on the front passenger seat.

You cannot manually activate or deactivate the front passenger air bag.

Also observe the following information:

- Status of the front passenger air bag: see "Function of the PASSENGER AIR BAG indicator lamps" (→ page 49)
- Notes on using the front passenger seat: see "Information on automatic front passenger air bag shutoff" (→ page 52)
- If you are driving with a child in the vehicle, observe the chapter "Children in the vehicle" (→ page 61)

Information on the child restraint system

When installing a child restraint system, observe the notes in "Children in the vehicle" (→ page 61).

Notes on the child restraint system on the front passenger seat

⚠ WARNING Risk of injury or fatal injuries if the front passenger air bag is enabled

If the front passenger air bag is enabled, a child on the front passenger seat may be struck by the front passenger air bag in the event of an accident.

▶ NEVER use a rearward-facing child restraint system on a seat with an ENABLED FRONT AIR BAG. This can result in the DEATH of or SERIOUS INJURY to the CHILD.

Also pay particular attention to the notes on rearward-facing or forward-facing child restraint systems on the front passenger seat (→ page 65).

Information on the automatic functions of the restraint system

Function of the automatic front passenger air bag shutoff

A person on the front passenger seat must observe the following information:

- Sit correctly (→ page 45).
- Fasten the seat belt correctly (→ page 46).

The automatic front passenger air bag shutoff can activate or deactivate the front passenger air bag according to the situation.

Make sure you observe the following information:

- Status of the front passenger air bag: see "Function of the PASSENGER AIR BAG indicator lamps" (→ page 49).
- When installing a child restraint system on the front passenger seat, observe the vehicle-specific information (→ page 65).

Status of the front passenger air bag in relation to the stature of the person:

- **Front passenger air bag deactivated:** PASSENGER AIR BAG OFF lights up continuously.

The front passenger air bag will not be deployed in the event of an accident. If PASSENGER AIR BAG OFF is lit, no one may use the front passenger seat.

- **Front passenger air bag activated:** PASSENGER AIR BAG ON lights up for up to 60 seconds or neither the PASSENGER AIR BAG ON nor OFF indicator lamps light up.

The front passenger air bag may be deployed in the event of an accident. Observe the information on the correct seat position (→ page 45).

Vehicles with rear seats: a person of smaller stature should use a rear seat.

System limits

The front passenger air bag may be deactivated by mistake, for example, in the following situation:

- The front passenger transfers their weight by supporting themselves on a vehicle armrest.
- The front passenger sits in such a way that their weight is raised from the seat surface.

! **NOTE** Deployment of components of the restraint system when the front passenger seat is unoccupied

In an accident, the components of the restraint system may deploy unnecessarily on the front passenger side if:

- There are heavy objects on the front passenger seat.
- The seat belt tongue is engaged in the seat belt buckle of the front passenger seat and the front passenger seat is unoccupied.

- ▶ Store objects in a suitable place.
- ▶ Only one person should use each seat belt at any one time.

Depending on the detected accident situation, the window curtain air bag on the front passenger side may deploy. The air bag is deployed regardless of whether the front passenger seat is occupied.

Function of PRE-SAFE® (anticipatory occupant protection)

PRE-SAFE® is able to detect certain critical driving situations and implement pre-emptive measures to protect the vehicle occupants.

PRE-SAFE® can implement the following measures independently of each other:

- Tightening the seat belts on the driver's seat and front passenger seat.
- Closing the side windows.
- **Vehicles with sliding sunroof:** closing the sliding sunroof.
- **Vehicles with memory function:** moving the front passenger seat to a more favorable seat position.

- **Vehicles with multicontour seat:** increasing the lateral support by inflating the seat side bolsters of the seat backrest.
- **PRE-SAFE® Sound:** provided that the multimedia system is switched on, generating a brief noise signal to stimulate the innate protective mechanism of a person's hearing.

! **NOTE** Damage caused by objects in the footwell or behind the seat

The automatic adjustment of the seat position may result in damage to the seat and/or the object.

- ▶ Stow objects in a suitable place.

Reversing the PRE-SAFE® system measures

If an accident did not occur, the pre-emptive measures that were taken will be reversed.

You will need to perform certain settings yourself.

- ▶ If the seat belt pre-tensioning is not reduced, move the seat backrest back slightly. The locking mechanism will release.

Function of PRE-SAFE® PLUS (anticipatory occupant protection plus)

PRE-SAFE® PLUS can detect certain impacts, particularly an imminent rear impact, and take pre-emptive measures to protect the vehicle occupants. These measures cannot necessarily prevent an imminent impact.

PRE-SAFE® PLUS can implement the following measures independently of each other:

- Tightening the seat belts on the driver's seat and front passenger seat.
- Increasing brake pressure when the vehicle is stationary. This brake application will be canceled automatically when the vehicle pulls away.

If an accident did not occur, the pre-emptive measures that were taken will be reversed.

System limits

The system will not initiate any action in the following situations:

- when the vehicle is backing up
or

- when the vehicle is towing a trailer and there is a risk of a rear impact

The system will not initiate any brake application in the following situations:

- while you are driving
or
- when you are entering or exiting a parking space while using Active Parking Assist

Function of PRE-SAFE® Impulse Side

If an imminent side impact is detected, PRE-SAFE® Impulse Side can pre-emptively move the front seat vehicle occupant's upper body towards the center of the vehicle. It does this by rapidly inflating an air cushion in the outer seat side bolster of the seat backrest on the side on which the impact is anticipated. This increases the distance between the door and the vehicle occupant.

If PRE-SAFE® Impulse Side has been deployed or is faulty, a display message reading **PRE-SAFE Pulse Side Inoperative See Operator's Manual**(→ page 469)will appear.

Seat belt adjustment function

Vehicles with PRE-SAFE®: after you have fastened the seat belt of the front seat, it may adjust itself against your body by pulling at the shoulder until somewhat tight. Do not hold the seat belt tightly while it is adjusting.

This function is a reminder that all vehicle occupants must wear their seat belts correctly.

You can activate and deactivate the seat belt adjustment function using the multimedia system (→ page 54).

Activating/deactivating seat belt adjustment via the multimedia system

Multimedia system:

- ➔  ➔ **Settings** ➔ **Vehicle**
- ➔ **Occupant Protection**
- ➔ Activate or deactivate **Belt adjustment**.

Overview of the automatic measures after an accident

Depending on the type and severity of the accident, and depending on the vehicle's equipment, the following measures may be implemented, for example:

- automatic braking (post-collision brake)
- activating the hazard warning lamps
- triggering an automatic emergency call (→ page 360)
- switching off the engine

To start the vehicle again, switch the vehicle off and on once more (→ page 172). Depending on the type and severity of the accident, you may no longer be able to start the vehicle.

- switching off the fuel supply
- **Plug-in hybrid:** switching off the hybrid system and high-voltage on-board electrical system
- unlocking the vehicle doors
- lowering the side windows
- displaying the emergency guide on the central display

- switching on the interior lighting

Function of the post-collision brake after an accident

Depending on the accident situation, the post-collision brake can minimise the severity of a further collision or even avoid it.

If an accident is detected, the post-collision brake can initiate automatic braking. When the vehicle has come to a standstill, the electric parking brake is automatically applied.

The driver can cancel automatic braking by taking the following actions:

- Braking more strongly than automatic braking
- Fully depressing the accelerator pedal with force

Purpose and function of the restraint system

Overview of deployment situations (restraint system)

Make sure that the following prerequisites in particular have been met so that the components of the restraint system are able to provide the intended level of protection:

- Sit correctly (→ page 45).
- Fasten the seat belt correctly (→ page 46).
 - Function of the seat belt warning lamp (→ page 48).
 - Function of the rear seat belt status display (→ page 49).
- The  restraint system warning lamp is not lit up after the self-test (→ page 47).
- The PASSENGER AIR BAG indicator lamps display the correct status of the front passenger air bag (→ page 49).

Depending on the detected deployment situation, the components of the restraint system can be activated or deployed independently of each other:

- Emergency Tensioning Device: frontal impact, rear impact, side impact, rollover
- Driver's air bag, front passenger air bag: frontal impact
- Knee bag: frontal impact
- Side impact air bag: side impact
- Window curtain air bag: side impact, rollover, frontal impact
- PRE-SAFE® Impulse Side: side impact

The installation location of an air bag is identified by the AIRBAG symbol (→ page 60).

Observe the information on the function of the restraint system (→ page 55).

Information on how the restraint system works

How the restraint system functions depends on the severity of the impact detected and the apparent type of accident.

For more information about types of accidents, see "Overview of deployment situations" (→ page 55).

The activation thresholds for the components of the restraint system are determined based on the evaluation of the sensor values measured at various points in the vehicle. This process is pre-emptive in nature. The triggering/deployment of the components of the restraint system must take place in good time at the start of the collision.

Factors that can be seen and measured only after a collision has occurred cannot play a decisive role in air bag deployment. Nor do they provide an indication of air bag deployment.

The vehicle may be deformed significantly without an air bag being deployed. This is the case if only parts which are relatively easily deformed are affected and the rate of vehicle deceleration is not high. Conversely, an air bag may be deployed even though the vehicle suffers only minor deformation. If very rigid vehicle parts such as longitudinal members are hit, this may result in sufficiently high levels of vehicle deceleration.

Depending on the apparent type of accident and the detected deployment situation, Emergency Tensioning Devices and/or air bags can supplement the protection offered by a correctly worn seat belt.

When enabled, an air bag can provide additional protection for the respective vehicle occupant.

Potential protection provided by each air bag:

- Knee air bag: thigh, knee and lower leg
- Driver's air bag, front passenger air bag: head and ribcage
- Window air bag: head
- Side air bag: ribcage and pelvis

However, no system available today can completely eliminate injuries and fatalities in every accident situation. In particular, the seat belt and air bag generally do not protect against objects penetrating the vehicle from the outside. It is also not possible to completely rule out the risk of injury caused by the air bag deploying.

Mercedes-Benz recommends that you have the vehicle towed to a qualified specialist workshop after an accident. Take this into account, particu-

larly if an Emergency Tensioning Device is triggered or an air bag deployed.

If the Emergency Tensioning Devices are triggered or an air bag is deployed, you will hear a bang, and a small amount of powder may also be released:

- The bang will not generally affect your hearing.
- In general, the powder released is not hazardous to health but may cause short-term breathing difficulties to persons suffering from asthma or other pulmonary conditions.
Provided it is safe to do so, leave the vehicle immediately or open the window in order to prevent breathing difficulties.

Air bags and pyrotechnic Emergency Tensioning Devices contain perchlorate material, which may require special handling or environmental protection measures. National guidelines regarding waste disposal must be observed. In California, see the <https://dtsc.ca.gov/>. Using the search function, you will find information on perchlorate, for example.

Information on the limited protection provided by the restraint system

Risk due to the incorrect behavior of vehicle occupants

All vehicle occupants must make sure of the following in particular:

- They observe the information on the correct seat position (→ page 45).
- There are no heavy, sharp-edged or fragile objects in the pockets of their clothing. Store such objects in a suitable place.

⚠ WARNING Risk of injury or death due to an incorrect seat position

The seat belt does not offer the intended level of protection if you have not moved the seat backrest to an almost vertical position.

In particular, you could slip beneath the seat-belt and become injured.

- ▶ Adjust the seat properly before beginning your journey.
- ▶ Always ensure that the seat backrest is in an almost vertical position and that

the shoulder belt is routed across the center of your shoulder.

Risk due to objects in the vehicle interior

All vehicle occupants must make sure of the following in particular:

- They observe the information on the correct seat position (→ page 45).
- There are no objects between the seat, door and door pillar (B-pillar).
- There are no hard objects, e.g. coat hangers, hanging on the grab handles or coat hooks.
- There are no heavy, sharp-edged or fragile objects in the pockets of their clothing. Store such objects in a suitable place.

⚠ WARNING Risk of injury or death due to blocked seat belt buckle or seat belt anchorage

Objects next to the front seat that block the seat belt buckle or the moving seat belt anchorage on the front seat impair the function of the Emergency Tensioning Devices.

- ▶ Before starting the journey, make sure that there are no objects around the seat belt buckle or between the front seat and door.

⚠ WARNING Risk of injury from objects in the deployment area of an airbag

Objects in the deployment area of an airbag can hinder or prevent the correct deployment of the airbag.

The airbag may then deploy in an uncontrolled manner and may even cause additional injuries to the vehicle occupants by deploying. This may be the case in particular if the airbag is integrated into the seat.

- ▶ Always stow and secure objects correctly.
- ▶ Before commencing your journey, make sure that no objects are stowed in the deployment area of an airbag.

The installation location of an air bag is identified by the AIRBAG (→ page 60) symbol.

Risk due to installing accessories

Do not attach accessories such as mobile navigation devices, mobile phones or cup holders within the deployment area of an air bag, e.g. on the cockpit, on the door, on the side window or on the side trim.

In addition, no connecting cables, tensioning straps or retaining straps may be routed or attached to the vehicle within the deployment area of an air bag. Always comply with the accessory manufacturer's installation instructions and, in particular, the notes on suitable places for installation.

▲ WARNING Risk of injury or death due to unsuitable protective covers

Unsuitable protective covers mean that air bags can no longer protect vehicle occupants as they are designed to do.

- ▶ Use only protective covers approved by Mercedes-Benz for the seat in question.

In addition, the function of the automatic passenger air bag deactivation may be restricted by an unsuitable protective cover. If the front

passenger seat is occupied, ensure that the PASSENGER AIR BAG indicator lamps display the correct status of the front passenger air bag (→ page 49).

Risk due to pets in the vehicle interior

▲ WARNING Risk of accident and injury due to animals left unsecured or unattended in the vehicle

If you leave animals in the vehicle unattended or unsecured, they could possibly press buttons or switches.

An animal may:

- Activate vehicle equipment and become trapped, for example
- Switch systems on or off and endanger other road users

Unsecured animals may be thrown around in the vehicle in the event of an accident or sudden steering and braking maneuvers and injure vehicle occupants in the process.

- ▶ Never leave animals in the vehicle unattended.
- ▶ Always correctly secure animals while driving, e.g. using a suitable animal carrier.

Risk due to modification, damage or wear to the components of the restraint system

▲ WARNING Risk of injury or death due to modifications to the restraint system

Vehicle occupants may no longer be protected as intended if alterations are made to the restraint system.

- ▶ Never alter the parts of the restraint system.
- ▶ Never tamper with the wiring or any electronic component parts or their software.

If it is necessary to modify the vehicle to accommodate a person with disabilities, contact an authorized Mercedes-Benz Center for details.

USA only: for details, contact our Customer Assistance Center on 1-800-FOR-MERCEdes (1-800-367-6372).

⚠ WARNING Risk of injury or death due to damaged or modified seat belts

Seat belts cannot provide protection in the following situations:

- The seat belt is damaged, has been modified, is extremely dirty, bleached or dyed
- The seat belt buckle is damaged or extremely dirty
- Modifications have been made to the Emergency Tensioning Device, seat belt anchorage or seat belt retractor

Seat belts may sustain non-visible damage in an accident, e.g. due to glass splinters.

Modified or damaged seat belts could tear or fail in the event of an accident, for example.

Modified Emergency Tensioning Devices could accidentally trigger or fail to function as intended.

- ▶ Never modify the seat belt system, for example the seat belt, seat belt buckle, Emergency Tensioning Device, seat belt anchorage and seat belt retractor.
- ▶ Make sure that the seat belts are undamaged, not worn and clean.
- ▶ Always have the seat belts checked immediately after an accident at a qualified specialist workshop.

Use only seat belts that have been approved for your vehicle by Mercedes-Benz.

⚠ WARNING Risk of injury due to modifications to the cover of an airbag

If you change the cover of an airbag or attach objects, e.g. even stickers, to it, the airbag may no longer function as intended.

- ▶ Never modify the cover of an airbag.
- ▶ Do not attach any objects to the cover.

The installation location of an air bag is identified by the AIRBAG symbol (→ page 60).

⚠ WARNING Risk of injury due to malfunctioning sensors in the door

The function of the airbags can be impaired due to modifications or incorrect work performed on the doors or door trim, or if the doors are damaged.

- ▶ Never modify the doors or parts of the doors.
- ▶ Always have work on the doors or door trim carried out at a qualified specialist workshop.

Risk due to components of the restraint system that have already been deployed

Mercedes-Benz recommends that you have the vehicle towed to a qualified specialist workshop after an accident.

⚠ WARNING Risk of burns from hot air bag components

The air bag parts are hot after an air bag has been deployed.

- ▶ Do not touch the air bag parts.

- ▶ Have a deployed air bag replaced at a qualified specialist workshop as soon as possible.

⚠ WARNING Risk of injury due to deployed airbag

A deployed airbag no longer offers any protection.

- ▶ Have the vehicle towed to a qualified specialist workshop in order to have the deployed airbag replaced.

Have deployed air bags replaced immediately.

⚠ WARNING Risk of injury or death from deployed pyrotechnic Emergency Tensioning Devices

Pyrotechnic Emergency Tensioning Devices that have been deployed are no longer operational and are unable to perform their intended protective function.

- ▶ Therefore, have deployed pyrotechnic Emergency Tensioning Devices immedi-

ately replaced at a qualified specialist workshop.

Seat belts

Releasing seat belts

- ▶ Press the release button in the seat belt buckle and guide the seat belt back with the seat belt tongue.

⚠ NOTE Damage caused by trapping the seat belt

If an unused seat belt is not fully retracted, it may become trapped in the door or in the seat mechanism.

- ▶ Always ensure that an unused seat belt is fully retracted.

Airbags

Overview of air bags

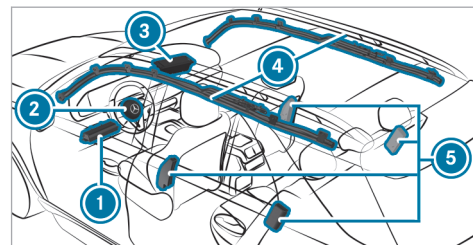

- ① Driver's knee air bag
- ② Driver's air bag
- ③ Front passenger air bag
- ④ Window curtain air bag
- ⑤ Side impact air bag

The installation location of an air bag is identified by the AIRBAG symbol.

Note the information under "Overview of deployment situations" (→ page 55).

Brief overview of most important points

Safely transporting children in the vehicle

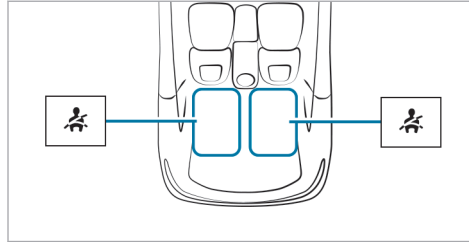
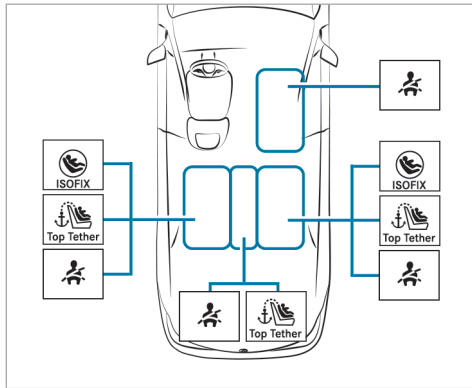

Always observe the following when transporting children:

- Never leave children unattended in the vehicle (→ page 63).
- Secure children up to a height of 5 ft (1.50 m) on the respective seat (see illustration above) properly with a suitable and approved child restraint system, and secure small children in a rearward-facing child restraint system.
- Observe the child restraint system manufacturer's installation instructions.

Left/right rear seat (preferred seats)

Second row of seats – preferred securing system:

 ISOFIX mounting brackets

and

 Also secure Top Tether if present (→ page 72).

Second row of seats – alternative securing system:

 Vehicle seat belt (→ page 73)

 Additionally attach Top Tether if recommended by the manufacturer of the child restraint system (→ page 72).

Third row of seats (if present), securing system:

 Vehicle seat belt (→ page 73)

Front passenger seat

Securing system:

 Vehicle seat belt (→ page 73)

Be sure to observe:

- If the front passenger seat is occupied, ensure that the status of the front passenger air bag is correct for the current situation (→ page 49).

(*) rearward-facing child restraint system only in combination with automatic air bag shutoff

Center rear seat (second row of seats only)

Securing system:



Vehicle seat belt (→ page 73)



Additionally attach Top Tether if recommended by the manufacturer of the child restraint system (→ page 72).

Important safety notes

Basic information

Be diligent

Bear in mind that negligence when securing a child in the child restraint system may have serious consequences. Always be diligent in securing a child carefully before every journey.

Never allow babies and children to travel sitting on the lap of another vehicle occupant.

To improve protection for children younger than 12 years old or under 5 ft (1.50 m) in height, Mercedes-Benz recommends you observe the following information:

- Always secure the child in a child restraint system suitable for this Mercedes-Benz vehicle.
- The child restraint system must be appropriate to the age, weight and size of the child.
- The vehicle seat must be suitable for the child restraint system to be installed:

Accident statistics show that children secured on the rear seats are generally safer than children secured on the front seats. For this reason, Mercedes-Benz strongly advises that you install a child restraint system on a rear seat.

The generic term "child restraint system"

The generic term "child restraint system" is used in this Operator's Manual. A child restraint system is, for example:

- a baby car seat

- a rearward-facing child seat
- a forward-facing child seat
- a child booster seat – Mercedes-Benz recommends using a child booster seat **with** a backrest and seat belt guide.

Observe laws and legal requirements

Always observe the legal requirements when using a child restraint system in the vehicle.

Securing systems for child restraint systems in the vehicle

Use only the following securing systems for child restraint systems:

- the LATCH-type (ISOFIX) securing rings
- the vehicle's seat belt system
- the Top Tether anchorages

Simply attaching to the LATCH-type (ISOFIX) securing rings on the vehicle can reduce the risk of installing the child restraint system incorrectly.

When securing a child with the integrated seat belt of the ISOFIX/LATCH child restraint system, always comply with the permissible gross weight

for the child and child restraint system (→ page 70).

A child booster seat may be necessary to achieve proper seat belt positioning for children over 40 lbs (18 kg) in weight or until they reach a height at which they can wear a three-point seat belt properly without a child booster seat.

Mercedes-Benz recommends a suitable child booster seat with a backrest and seat belt guide.

Observe standards for child restraint systems

All child restraint systems must meet the following standards:

- U.S. Federal Motor Vehicle Safety Standards 213
- Canadian Motor Vehicle Safety Standards 213

Confirmation that the child restraint system complies with the standards can be found on an instruction label on the child restraint system. This confirmation can also be found in the installation instructions that are included with the child restraint system.

Important warning notices

Always secure a child restraint system correctly

⚠ WARNING Risk of injury or death due to incorrect installation of the child restraint system

The child can then not be protected or restrained as intended.

- ▶ Be sure to comply with the manufacturer's installation instructions for the child restraint system and its correct use.
- ▶ Make sure that the entire base of the child restraint system always rests on the sitting surface of the seat.
- ▶ Never place objects (e.g. cushions) under or behind the child restraint system.
- ▶ Use child restraint systems only with the original cover designed for them.
- ▶ Always replace damaged covers with genuine covers.

- Always observe the vehicle-specific information.
 - Installing an ISOFIX/LATCH child restraint system on the right and left rear seats (→ page 70).
 - Securing the child restraint system with the seat belt (→ page 73).
- Observe the warning labels in the vehicle interior and on the child restraint system.

⚠ WARNING Risk of injury or death due to unsecured child restraint systems in the vehicle

If the child restraint system is incorrectly mounted or unsecured, it may come loose.

The child can then not be protected or restrained as intended.

Unused child restraint systems could be flung around and hit vehicle occupants.

- ▶ Always comply with the manufacturer's installation instructions for the child restraint system and its correct use.

- ▶ Always fit child restraint systems correctly, even if they are transported in the vehicle unused.

Do not modify the child restraint system

⚠ WARNING Risk of injury due to modifications to the child restraint system

The child restraint system can no longer function properly. This poses an increased risk of injury.

- ▶ Never modify a child restraint system.
- ▶ Only affix accessories which have been specially approved for this child restraint system by the child restraint system's manufacturer.

Only use child restraint systems which are in proper working condition

⚠ WARNING Risk of injury or death caused by the use of damaged child restraint systems

Child restraint systems or their retaining systems that have been subjected to stress in an accident may not be able to perform their intended protective function.

It may be the case that the child cannot be properly restrained.

- ▶ Always immediately replace child restraint systems that have been damaged or involved in an accident.
- ▶ Have the securing systems for the child restraint systems checked at a qualified specialist workshop before installing a child restraint system again.

Avoid direct sunlight

⚠ WARNING Risk of burns when the child seat is exposed to direct sunlight

If the child restraint system is exposed to direct sunlight or heat, parts could heat up excessively.

Children could suffer burns from these parts, particularly the metallic parts of the child restraint system.

- ▶ Always make sure that the child restraint system is not exposed to direct sunlight.
- ▶ Cover the child restraint system with a blanket, for example.
- ▶ If the child restraint system has been exposed to direct sunlight, allow it to cool before securing a child into it.
- ▶ Never leave children unattended in the vehicle.

Observe when stopping or parking

⚠ WARNING Risk of fatal injury due to exposure to extreme heat or cold in the vehicle

If persons, particularly children, are subjected to prolonged exposure to intense heat or cold, there is a risk of severe injury or even death.

- ▶ Never leave persons, particularly children, unattended in the vehicle.

⚠ WARNING Risk of accident and injury due to children left unattended in the vehicle

If you leave children unattended in the vehicle, they could, in particular:

- open doors, thereby endangering other persons or road users.
- get out and be struck by oncoming traffic.
- operate vehicle equipment and become trapped, for example.

In addition, the children could also set the vehicle in motion by, for example:

- releasing the parking brake.
 - changing the gearbox position.
 - starting the vehicle.
- ▶ Never leave children unattended in the vehicle.
 - ▶ When leaving the vehicle, always take the key with you and lock the vehicle.
 - ▶ Keep the key out of reach of children.

Notes on rearward-facing and forward-facing child restraint systems on the front passenger seat

⚠ WARNING Risk of injury or fatal injury when using a rearward-facing child restraint system while the co-driver airbag is enabled

If you secure a child in a rearward-facing child restraint system on the co-driver seat and the PASSENGER AIR BAG OFF indicator lamp is

off, the co-driver airbag can deploy in the event of an accident.

The child could be struck by the airbag.

- ▶ Always ensure that the co-driver airbag is disabled. The PASSENGER AIR BAG OFF indicator lamp must be lit.
- ▶ NEVER use a rearward-facing child restraint system on a seat with an ENABLED FRONT AIRBAG; DEATH or SERIOUS INJURY to the CHILD can occur.

Observe the specific instructions for the rearward-facing and forward-facing child restraint systems (→ page 68).

If it is absolutely necessary to install a child restraint system on the front passenger seat, always observe the following notes:

- When using a rearward-facing child restraint system on the front passenger seat, the front passenger air bag must always be disabled. This is only the case if the PASSENGER AIR BAG OFF indicator lamp is lit continuously (→ page 49).

- The front passenger air bag is enabled when the PASSENGER AIR BAG OFF indicator lamp is not lit. The front passenger air bag may be deployed during an accident. In that case, do not use rearward-facing child restraint systems.

Information on automatic front passenger air bag shutoff

If the front passenger seat is occupied, ensure, both before and during the journey, that the status of the front passenger air bag is correct for the current situation.

⚠ WARNING Risk of injury or death due to objects between the seat surface and the child restraint system

Objects between the seat surface and the child restraint system can interfere with the function of the automatic front passenger air bag shutoff.

- ▶ Do not place any objects between the seat surface and the child restraint system.
- ▶ Make sure that the entire base of the child restraint system rests on the seat cushion of the front passenger seat.
- ▶ The backrest of a forward-facing child restraint system must, as far as possible, be resting against the seat backrest of the front passenger seat.
- ▶ Always comply with the installation instructions from the child restraint system manufacturer.

When installing a child restraint system on the front passenger seat, observe the vehicle-specific information (→ page 65).

Rearward-facing child restraint system on the front passenger seat

If a rearward-facing child restraint system is installed on the front passenger seat, the front passenger air bag must be disabled. The PASSENGER AIR BAG OFF indicator lamp must be continuously lit (→ page 49).

⚠ WARNING Risk of injury or fatal injury when using a rearward-facing child restraint system while the co-driver airbag is enabled

If you secure a child in a rearward-facing child restraint system on the co-driver seat and the PASSENGER AIR BAG OFF indicator lamp is off, the co-driver airbag can deploy in the event of an accident.

The child could be struck by the airbag.

- ▶ Always ensure that the co-driver airbag is disabled. The PASSENGER AIR BAG OFF indicator lamp must be lit.
- ▶ NEVER use a rearward-facing child restraint system on a seat with an ENABLED FRONT AIRBAG; DEATH or SERIOUS INJURY to the CHILD can occur.

i Depending on the child restraint system and the stature of the child, the front passenger air bag will be enabled. The PASSENGER AIR BAG OFF indicator lamp will not light up.

The front passenger air bag may be deployed during an accident. If the front passenger air bag has this status, no rearward-facing child restraint system may be installed on the front passenger seat.

Instead, install the rearward-facing child restraint system on a suitable rear seat.

Forward-facing child restraint system on the front passenger seat

If a forward-facing child restraint system is installed on the front passenger seat, the front passenger air bag may be automatically enabled or disabled. The status of the front passenger air bag depends on the child restraint system and the stature of the child.

The PASSENGER AIR BAG OFF indicator lamp will either light up continuously or not light up (→ page 49). Always observe the following information.

⚠ WARNING Risk of injury or death due to incorrect positioning of the child restraint system

If you secure a child in a forward-facing child restraint system on the co-driver seat and you position the co-driver seat too close to the dashboard, in the event of an accident, the child could:

- come into contact with the vehicle's interior if the PASSENGER AIR BAG OFF indicator lamp is lit, for example
 - be struck by the airbag if the PASSENGER AIR BAG OFF indicator lamp is off
- ▶ Always move the co-driver seat as far back as possible. In doing so, always make sure that the shoulder belt strap is correctly routed from the seat belt outlet of the vehicle to the shoulder belt guide on the child restraint system. The shoulder belt strap must be routed forwards and downwards from the seat belt outlet. If necessary, adjust the seat belt outlet and the co-driver seat accordingly.

▶ Always comply with the child restraint system manufacturer's installation instructions.

Be sure to also observe the following further related subjects:

- Function of the automatic front passenger air bag shutoff (→ page 49)

Suitable child restraint systems for the transport of children

Information on the benefit of a rearward-facing child restraint system

Transport a baby in a suitable rearward-facing child restraint system only. It is also preferable to transport a small child in a suitable rearward-facing child restraint system. In this case, the child sits in the opposite direction to the direction of travel and faces backwards.

Babies and small children have comparatively weak neck muscles in relation to the size and weight of their head. The risk of injury to the cer-

vical spine during an accident can be reduced in a rearward-facing child restraint system.

Securing the child restraint system

Adjusting the seat correctly

When installing a child restraint system on the left or right rear seat, always observe the following:

- ▶ Make sure that the child's feet do not touch the front seat. If necessary, move the front seat slightly forwards.

If the head restraint of the child restraint system cannot be fully extended when it is installed in the vehicle, this will result in restrictions on the maximum size setting for certain child restraint systems. Observe the child restraint system manufacturer's installation instructions.

- ⓘ Contact with the roof when the head restraint is fully extended and locked in place will not result in any restrictions on use.

 When installing an ISOFIX/LATCH child restraint system, also observe the following:

- ▶ **When using a rearward-facing child restraint system on a rear seat:** adjust the front seat so that it does not touch the child restraint system.
- ▶ **When using a forward-facing child restraint system with integrated child seat belt:** adjust the head restraint of the respective seat so that it does not push the child restraint system forwards. If necessary, the respective head restraint can be removed. In addition, the backrest of the child restraint system must lie as flat as possible against the backrest of the vehicle seat. After the child restraint system has been removed, replace the vehicle head restraint immediately and adjust it correctly.
- ▶ The child restraint system must not be put under strain between the roof and the seat cushion and/or be installed facing the wrong direction. Where possible, adjust the seat cushion inclination accordingly.

- ▶ Adjust the vehicle head restraints so that the child restraint system is not put under strain by the head restraint.

 When installing a belt-secured child restraint system, also observe the following:

- ▶ **When using a rearward-facing child restraint system on a rear seat:** adjust the front seat so that it does not touch the child restraint system.
- ▶ Also secure Top Tether if available (→ page 72)
- ▶ **When using a forward-facing child restraint system with integrated child seat belt:** adjust the head restraint of the respective seat so that it does not push the child restraint system forwards. If necessary, the respective head restraint can be removed. In addition, the backrest of the child restraint system must lie as flat as possible against the backrest of the vehicle seat. After the child restraint system has been removed, replace the vehicle head restraint immediately and adjust it correctly.

- ▶ The backrest of a forward-facing child restraint system must, as far as possible, be resting on the seat backrest of the rear seat.
- ▶ The child restraint system must not be put under strain between the roof and the seat cushion and/or be installed facing the wrong direction. Where possible, adjust the seat cushion inclination accordingly.
- ▶ Adjust the vehicle head restraints so that the child restraint system is not put under strain by the head restraint.
- ▶ Make sure that the child's feet do not touch the front seat. If necessary, move the front seat slightly forwards.

 Depending on the vehicle equipment, always observe the following when installing a belt-secured child restraint system on the front passenger seat:

- ▶ Observe the notes on rearward-facing and forward-facing child restraint systems on the front passenger seat (→ page 65).
- ▶ **When using a forward-facing child restraint system with integrated child seat belt:** remove

the head restraint from the respective seat, if possible. After the child restraint system has been removed, immediately replace the head restraint and adjust it correctly.

- ▶ The backrest of the forward-facing child restraint system must, as far as possible, be resting on the seat backrest of the front passenger seat.
- ▶ The child restraint system must not be put under strain between the roof and the seat cushion and/or be installed facing the wrong direction.
- ▶ Adjust the vehicle head restraints so that the child restraint system is not put under strain by the head restraint.
- ▶ Never place objects (e.g. cushions) under or behind the child restraint system.
- ▶ Set the front passenger seat as far back as possible and move the seat into the highest position if possible. Always make sure that the shoulder belt strap is correctly routed from the seat belt outlet of the vehicle to the shoulder belt guide on the child restraint system. The shoulder belt strap must be routed for-

wards from the seat belt outlet and, where possible, downwards to the child restraint system.

- ▶ Fully retract the seat cushion length adjustment.
- ▶ Adjust the seat cushion inclination so that the front edge of the seat cushion is in the highest position and the rear edge of the seat cushion is in the lowest position.
- ▶ Set the seat backrest to the most vertical position possible.

Activating or deactivating the special seat belt retractor of the seat belt

 **WARNING** Risk of injury or death if a seat belt is unfastened while the vehicle is in motion

If the seat belt is released while the vehicle is in motion, the special seat belt retractor is deactivated and the child restraint system is no longer correctly secured. The seat belt is drawn in slightly by the inertia reel and cannot be immediately closed again.

- ▶ Stop the vehicle immediately in accordance with the traffic conditions.
- ▶ Activate the special seat belt retractor again and correctly secure the child restraint system.

When enabled, the child seat safety feature ensures that the seat belts of the front passenger seat and rear seats do not slacken once the child restraint system is secured.

The seat belts on the following seats are equipped with a child seat safety feature:

- Front passenger seat
- Rear seats

Installing a child restraint system

- ▶ When installing a child restraint system, always observe the manufacturer's installation and operating instructions as well as the information in this Operator's Manual.
- ▶ Pull the seat belt smoothly from the seat belt outlet.
- ▶ Engage the seat belt tongue in the belt buckle.

Activating the special seat belt retractor:

- ▶ Pull the seat belt out fully and let the inertia reel retract it again. When the special seat belt retractor is activated, you should hear a ratcheting sound.
- ▶ Push the child restraint system down until the seat belt sits tightly.

Deactivating the special seat belt retractor:

- ▶ Press the release button of the seat belt buckle.
- ▶ Hold the seat belt tongue and guide back to the seat belt outlet.

Installing an ISOFIX/LATCH child restraint system

⚠ WARNING Risk of accident if the rear bench seat, rear seat and seat backrest are not engaged

The rear bench seat, rear seat and seat backrest may fold forwards, even when you are driving.

- As a result, the vehicle occupant will be pushed into the seat belt with increased force. The seat belt will not be able to protect as intended and could cause additional injury.
 - Objects or loads in the trunk or cargo compartment will not be restrained by the seat backrest.
- ▶ Make sure that the rear bench seat, the rear seat and the seat backrest are engaged before every trip.

If the seat backrest is not engaged and locked in place, this will be shown on the instrument display (folding the rear seat back electrically) or the red lock verification indicator will be visible (folding the rear seat back manually).

⚠ WARNING Risk of injury or death if the permissible gross mass of the child and child restraint system together is exceeded.

Too much load may be placed on the LATCH-type (ISOFIX) or iSize child restraint systems and the child may not be restrained correctly in the event of an accident, for example.

- ▶ If the child is secured in a LATCH-type (ISOFIX) child restraint system with integrated seat belt, the total mass of the child and child restraint system must not exceed 73 lb (33 kg).

Always comply with the information about the mass of the child:

- in the manufacturer's installation and operating instructions for the child restraint system used
- on a label on the child restraint system, if present

Regularly check that the permissible gross mass of the child and child restraint system is still complied with.

When installing a child restraint system, observe the following:

- ☑ Always observe the correct use of the seats and consider their suitability for attaching a child restraint system.

LATCH-type (ISOFIX) mounting brackets

- ▶ Before every journey, make sure that the ISO-FIX/LATCH child restraint system is engaged in both securing rings in the vehicle.

⚠ NOTE Damage to the seat belt for the center seat during installation of the child restraint system

- ▶ Make sure that the seat belt is not trapped.

Vehicles with rigid rear seats:

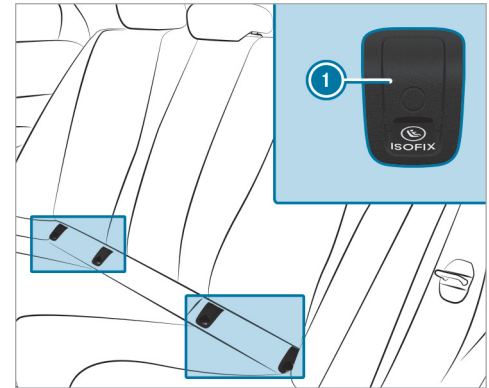

- ① LATCH-type (ISOFIX) mounting bracket
- ▶ Remove and stow away covers ① of the mounting brackets in the vehicle.
- ▶ Attach the ISOFIX/LATCH child restraint system to both mounting brackets in the vehicle.
- ▶ After removing the child restraint system, reattach covers ①.

Vehicles with adjustable rear seats:

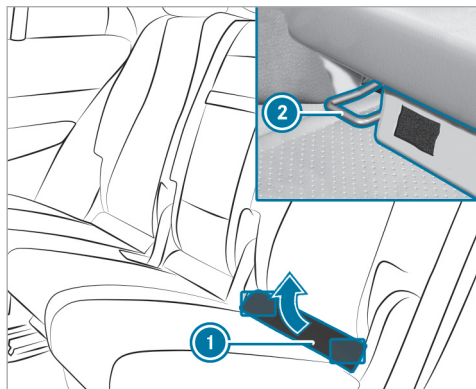

- ▶ Fold upholstered lining ① up.
- ▶ Turn the support on the rear side of upholstered lining ① by 90°. Upholstered lining ① remains folded up.
- ▶ Attach the ISOFIX/LATCH child restraint system to both mounting brackets ② in the vehicle.

Fastening a Top Tether

⚠ WARNING Risk of injury or death if the rear seat backrests are not locked after Top Tether belts are installed

The rear seat backrests may fold forwards when you are driving.

As a result, child restraint systems will no longer be able to perform their intended protective function. This may also cause additional injuries.

- ▶ Always lock rear seat backrests after installing Top Tether belts.
- ▶ Observe the lock verification indicator.

If the seat backrest is not engaged and locked in place, this will be shown on the instrument display (folding the rear seat back electrically) or the red lock verification indicator will be visible (folding the rear seat back manually).



If the child restraint system is equipped with a Top Tether belt:

The risk of injury may be reduced by Top Tether. The Top Tether belt enables an

additional connection between the child restraint system attached with ISOFIX (left and right rear seats) or the seat belt (all rear seats) and the vehicle.

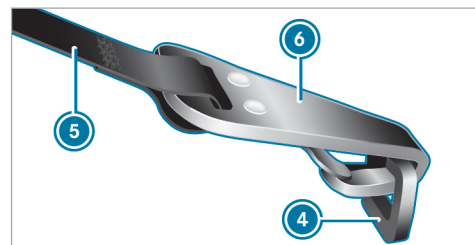
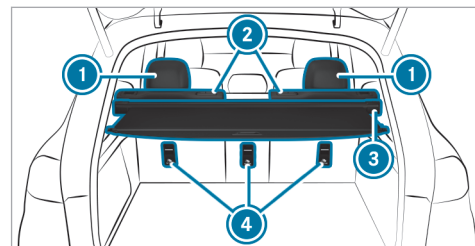

- ▶ If necessary, slide head restraint ① upwards (→ page 110).
- ▶ Install the ISOFIX/LATCH or belt-secured child restraint system with Top Tether. In doing so, comply with the child restraint system manufacturer's installation instructions.
- ▶ Guide Top Tether belt ⑤ under head restraint ① between the two head restraint bars.
- ▶ If cargo compartment cover ③ is installed, guide Top Tether belt ⑤ downwards between cargo compartment cover ③ and seat backrest ②.
- ▶ Hook Top Tether hook ⑥ of Top Tether belt ⑤ into Top Tether anchorage ④ without twisting.
- ▶ Tension Top Tether belt ⑤. In doing so, comply with the child restraint system manufacturer's installation instructions.
- ▶ If necessary, slide head restraint ① downwards (→ page 110). Make sure that you do not interfere with the correct routing of Top Tether belt ⑤.

Securing the child restraint system with the seat belt

⚠ WARNING Risk of accident if the rear bench seat, rear seat and seat backrest are not engaged

The rear bench seat, rear seat and seat backrest may fold forwards, even when you are driving.

- As a result, the vehicle occupant will be pushed into the seat belt with increased force. The seat belt will not be able to protect as intended and could cause additional injury.
 - Objects or loads in the trunk or cargo compartment will not be restrained by the seat backrest.
- ▶ Make sure that the rear bench seat, the rear seat and the seat backrest are engaged before every trip.

If the seat backrest is not engaged and locked in place, this will be shown on the instrument display (folding the rear seat back electrically) or the red

lock verification indicator will be visible (folding the rear seat back manually).

The seat belts on the following seats are equipped with a child seat safety feature:

- Front passenger seat
- Rear seats

When enabled, the child seat safety feature ensures that the seat belts of the front passenger seat and rear seats do not slacken once the child restraint system is secured.

- ▶ For a child restraint system in the "Universal" or "Semi-Universal" category, make sure that the system has been approved for the vehicle seat.
- ▶ Install the child restraint system. The entire base of the child restraint system must always rest on the surface of the seat.
- ▶ Always make sure that the shoulder belt strap is correctly routed from the seat belt outlet of the vehicle to the shoulder belt guide on the child restraint system. The shoulder belt strap must be routed forwards from the seat belt outlet and, where

possible, downwards to the child restraint system.

- ▶ **When installing on the rear seat:** also secure Top Tether if present.
- ▶ **When installing on the front passenger seat:** if necessary, adjust the seat belt outlet and the front passenger seat accordingly.

Child safety locks

Activating or deactivating the child safety lock for the rear doors

⚠ WARNING Risk of accident and injury due to children left unattended in the vehicle

If you leave children unattended in the vehicle, they could, in particular:

- open doors, thereby endangering other persons or road users.
- get out and be struck by oncoming traffic.
- operate vehicle equipment and become trapped, for example.

In addition, the children could also set the vehicle in motion by, for example:

- releasing the parking brake.
- changing the gearbox position.
- starting the vehicle.
- ▶ Never leave children unattended in the vehicle.
- ▶ When leaving the vehicle, always take the key with you and lock the vehicle.
- ▶ Keep the key out of reach of children.

⚠ WARNING Risk of fatal injury due to exposure to extreme heat or cold in the vehicle

If persons, particularly children, are subjected to prolonged exposure to intense heat or cold, there is a risk of severe injury or even death.

- ▶ Never leave persons, particularly children, unattended in the vehicle.

⚠ WARNING Risk of accident and injury due to children left unattended in the vehicle

If children are traveling in the vehicle, they could, in particular:

- Open doors, thereby endangering other persons or road users.
- Get out and be struck by oncoming traffic.
- Operate vehicle equipment and become trapped, for example.
- ▶ Always activate the installed child safety locks if children are traveling in the vehicle.
- ▶ Never leave children unattended in the vehicle.
- ▶ When leaving the vehicle, always take the SmartKey with you and lock the vehicle.

There are child safety locks for the rear doors and the rear side windows.

The child safety lock on the rear doors secures each door separately. The doors can no longer be opened from the inside.

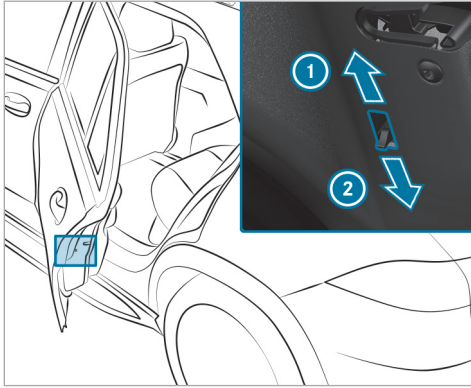

- ▶ Press the lever in direction ① (activate) or ② (deactivate).
- ▶ Make sure that the child-proof locks are working properly.

Activating and deactivating the child safety lock for the rear side windows

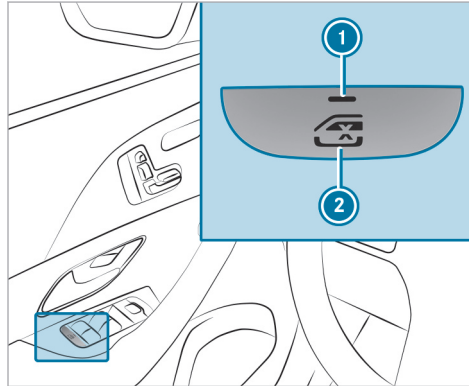

- ▶ **To activate/deactivate:** press button ②.

The rear side window can be opened or closed in the following cases:

- Indicator lamp ① is lit: via the switch on the driver's door

- Indicator lamp ① is off: via the switch on the corresponding rear door or driver's door

SmartKey

Overview of key functions

⚠ WARNING Risk of accident and injury due to children left unattended in the vehicle

If you leave children unattended in the vehicle, they could, in particular:

- open doors, thereby endangering other persons or road users.
- get out and be struck by oncoming traffic.
- operate vehicle equipment and become trapped, for example.

In addition, the children could also set the vehicle in motion by, for example:

- releasing the parking brake.
- changing the gearbox position.
- starting the vehicle.

▶ Never leave children unattended in the vehicle.

- ▶ When leaving the vehicle, always take the key with you and lock the vehicle.
- ▶ Keep the key out of reach of children.

! **NOTE** Damage to the SmartKey caused by magnetic fields

- ▶ Keep the SmartKey away from strong magnetic fields.

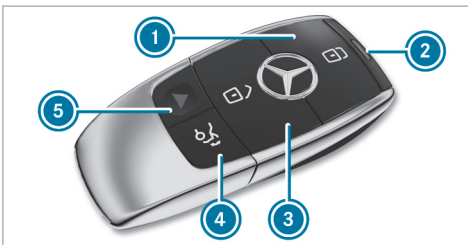



Vehicle key with panic alarm

- ① Locks the vehicle
- ② Indicator lamp
- ③ Unlocks the vehicle

④ Opens/closes the tailgate

⑤ Panic alarm

ⓘ If indicator lamp ② does not light up after pressing the  or  button, the battery is weak or possibly discharged. Replace the battery as soon as possible.

Replace the key battery (→ page 78).

The key locks and unlocks the following components:

- Doors
- Fuel filler flap
- Socket flap (plug-in hybrid)
- Tailgate

If the vehicle is not opened within approximately 40 seconds after unlocking, it locks again. Anti-theft protection is activated again.

Do not keep the key together with electronic devices or metal objects. This can affect the key's functionality.

Do not keep the key in the temperature-controlled cup holder. Otherwise, the key will not be reliably detected.

Activating/deactivating the acoustic locking verification signal

Multimedia system:

→  >> Settings >> Vehicle
 >> Open/Close



- ▶ Activate or deactivate the **Acoustic Lock**.

Activating/deactivating the panic alarm

Requirements



- The vehicle is switched off.



- ▶ **To activate:** press button  for approximately one second. A visual and audible alarm is triggered.
 - ▶ **To deactivate:** briefly press button  again.
- or
- ▶ Press the start/stop button. A key belonging to the vehicle must be detected in the vehicle.

Changing the unlocking settings

Possible unlocking functions of the SmartKey:

- Central unlocking
 - Unlocking the driver's door and fuel filler flap
 - **Plug-in hybrid:** unlocking the driver's door and fuel filler flap/socket flap
- ▶ **To switch between settings:** press the  and  buttons simultaneously for approximately six seconds until the indicator lamp flashes twice.

Options when the unlocking function for the driver's door and fuel filler flap has been selected:

- **To unlock the vehicle centrally:** press the  button twice.
- **Vehicles with KEYLESS-GO:** if you touch the inner surface of the door handle on the driver's door, only the driver's door and the fuel filler flap will be unlocked.

Options when the unlocking function for the driver's door and fuel filler flap/socket flap has been selected (plug-in-hybrid):



- **To unlock the vehicle centrally:** press the  button twice.
- **Vehicles with KEYLESS-GO:** if you touch the inner surface of the door handle on the driver's door, only the driver's door and the fuel filler flap/socket flap will be unlocked.

Deactivating the function of the key

Vehicles with KEYLESS-GO: if you deactivate the function of the key, the KEYLESS-GO functions are also deactivated. Access or drive authorization by KEYLESS-GO is then no longer possible with that

particular key. Activate the function of the key so that all its functions will again be available.

You can also deactivate the function of the key to reduce the energy consumption of the key if you do not use the vehicle or a key for an extended period of time.

- ▶ Press and hold the  button on the key.
- ▶ With the key button  pressed, immediately press key button  twice in quick succession.
The indicator light of the key lights up once briefly and once for a long time.

- ① You have the following options to reactivate the key:
 - Press any button on the key.
 - Start the vehicle with the key in the center console stowage space (→ page 173).

Removing/inserting the mechanical key

Removing the mechanical key

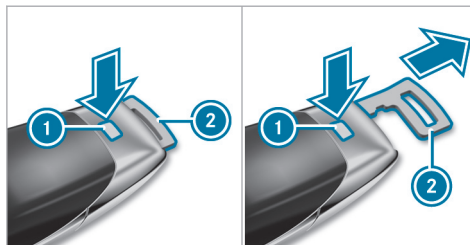

- ▶ Press release button ①. Emergency key ② is pushed out slightly.
- ▶ Pull out mechanical key ② until it engages in the intermediate position.
- ▶ Press release button ① again and fully remove mechanical key ②.

Inserting the mechanical key

- ▶ Press release button ①.
- ▶ Insert mechanical key ② to the intermediate position or fully until it engages.

- ① You can use the intermediate position of mechanical key ② to attach the key to a key ring.

Replacing the key battery

⚠ DANGER Risk of fatal injury due to swallowing batteries

Batteries contain toxic and corrosive substances. If batteries are swallowed or otherwise enter the body, severe internal burns can occur within two hours.

There is a risk of fatal injury!

- ▶ Keep the batteries out of the reach of children.
- ▶ If the lid and/or the battery compartment do not close securely, stop using the key and keep it away from children.
- ▶ If batteries are swallowed or otherwise enter the body, seek immediate medical attention.

 **ENVIRONMENTAL NOTE** Environmental damage due to improper disposal of batteries



Batteries contain pollutants. It is illegal to dispose of them with the household rubbish.



Dispose of batteries in an environmentally responsible manner. Take discharged batteries to a qualified specialist workshop or to a collection point for used batteries.

Requirements

- You require a CR 2032 3 V cell battery.

Mercedes-Benz recommends that you have the battery replaced at a qualified specialist workshop.

- Remove the mechanical key (→ page 78).

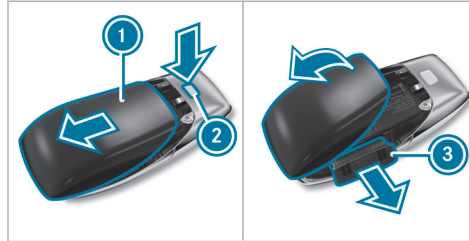

- Press release knob (2) down fully and slide cover (1) in the direction of the arrow.
- Fold out cover (1) in the direction of the arrow and remove.
- Remove battery compartment (3) and take out the discharged battery.
- Insert the new battery into battery compartment (3). Observe the positive pole marking in the battery compartment and on the battery when doing this.
- Push in battery compartment (3).
- Re-attach cover (1) and push it until it engages.

Problems with the key, troubleshooting

You can no longer lock or unlock the vehicle

Possible causes are:

- The key battery is weak or discharged.
- Check the battery using the indicator lamp (→ page 76).
- Replace the key battery, if necessary (→ page 78).
- Use the replacement key.
- Use the mechanical key to lock or unlock (→ page 83).
- Have key checked at a qualified specialist workshop.

There is interference from a powerful radio signal source

Possible causes if the function of the key is impaired:

- high voltage power lines
- mobile phones
- electronic devices (notebooks, tablets)

- shielding due to metal objects or induction loops for electrical gate systems or automatic barriers

▶ Make sure that there is sufficient distance between the key and the potential source of interference.

You have lost a key

- ▶ Have the key deactivated at a qualified specialist workshop.
- ▶ If necessary, have the mechanical lock replaced as well.

Doors

Unlocking/opening the doors from the inside

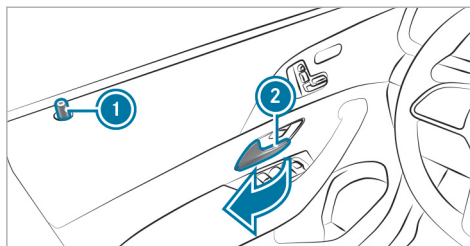

- ▶ **To unlock and open a front door:** pull door handle ②. Locking pin ① pops up when the door is unlocked.
- ▶ **To unlock a rear door:** pull the rear door handle. The locking pin pops up when the rear door is unlocked.
- ▶ **To open a rear door:** pull the rear door handle again.

Centrally locking and unlocking the vehicle from the inside

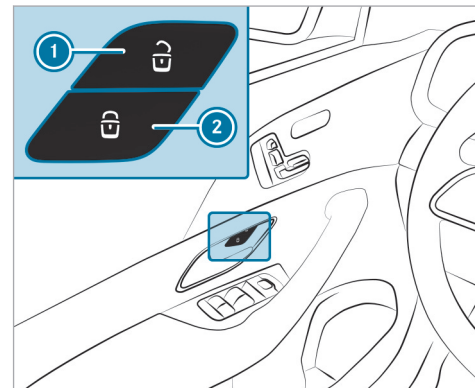

- ▶ **To unlock:** press ① button.
- ▶ **To lock:** press button ②.

This does not lock or unlock the fuel filler flap.

Plug-in hybrid: the socket flap is also locked and unlocked. The socket flap can be opened even if a key is detected in the car.

The vehicle is not unlocked:

- if you have locked the vehicle using the key
- if you have locked the vehicle using KEYLESS-GO

Locking/unlocking the vehicle with KEYLESS-GO

Requirements

- The key is outside the vehicle.
- The distance between the key and the vehicle does not exceed 3 ft (1 m).
- The driver's door and the door on which the door handle is used are closed.

! **NOTE** Vehicle damage due to unintentional opening of the tailgate

- When using an automatic car wash
- When using a high pressure cleaner

▶ Deactivate the function of the SmartKey in these situations.

or

▶ Make sure that the SmartKey is at a minimum distance of 10 ft (3 m) away from the vehicle.

Observe the notes:

- on washing the vehicle in a car wash (→ page 378)
- on using a high-pressure cleaner (→ page 381)

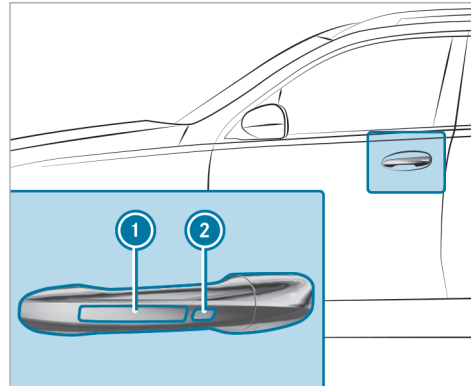

▶ **To unlock the vehicle:** touch the inner surface of the door handle.

▶ **To lock the vehicle:** touch sensor surface ① or ②.

▶ **Convenience closing:** touch recessed sensor surface ② until the closing process has been completed.

① Further information on convenience closing (→ page 91).

If you open the tailgate from outside, it is automatically unlocked.

Problems with KEYLESS-GO, troubleshooting

You can no longer lock or unlock the vehicle using KEYLESS-GO

Possible causes:

- The function of the SmartKey has been deactivated.
- The SmartKey battery is weak or discharged.

▶ Activate the function of the SmartKey (→ page 77).

- ▶ Check the battery using the indicator lamp (→ page 76).
- ▶ Replace the SmartKey battery, if necessary (→ page 78).
- ▶ Use the replacement SmartKey.
- ▶ Use the emergency key to lock or unlock (→ page 83).
- ▶ Have the vehicle and SmartKey checked at a qualified specialist workshop.

There is interference from a powerful radio signal source

Possible causes if the function of KEYLESS-GO is impaired:

- High voltage power lines
 - Mobile phones
 - Electronic devices (notebooks, tablets)
 - Shielding due to metal objects or induction loops for electrical gate systems or automatic barriers
- ▶ Make sure that there is sufficient distance between the SmartKey and the potential source of interference.

Activating/deactivating the automatic locking feature

The vehicle is locked automatically when the vehicle is switched on and the wheels are turning faster than walking pace.

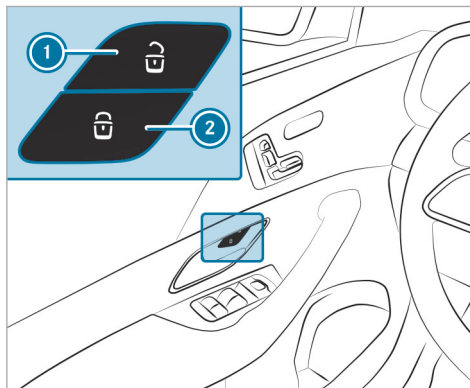

- ▶ **To activate:** press and hold button ② for approximately five seconds until an acoustic signal sounds.

- ▶ **To deactivate:** press and hold button ① for approximately five seconds until an acoustic signal sounds.

In the following situations, there is a danger of being locked out when the function is activated:

- while the vehicle is being tow-started or pushed
- if the vehicle is being tested on a roller dynamometer

Activating or deactivating the automatic locking feature

Multimedia system:

→ ▶ Settings ▶ Vehicle
▶ Open/Close

- ① The vehicle is locked automatically when the vehicle is switched on and the wheels are turning faster than walking pace.

- ▶ Activate or deactivate **Automatic Door Lock**.

In the following situations, there is a danger of being locked out when the function is activated:

- The vehicle is being towed or pushed.

- If the vehicle is being tested on a roller dynamometer.

Power closing function

⚠ WARNING Risk of becoming trapped when the doors close automatically

Body parts or objects can become trapped, causing injuries.

- ▶ Ensure that no body parts or objects are in the closing area.
- ▶ Automatic closing of the doors can be canceled by pulling the outer or inner door handle.

If you push the door into the lock to the first detent position, the power closing function will automatically pull the door into the lock.

Locking/unlocking the driver's door with the mechanical key

- ⓘ If you wish to lock the vehicle entirely using the mechanical key, first press the button for

locking from the inside while the driver's door is open. Then proceed to lock the driver's door using the mechanical key.

- ⓘ If you unlock and open the driver's door with the mechanical key, this triggers the burglar alarm system.
- ⓘ If you unlock the driver's door with the mechanical key, the tailgate will not be unlocked.

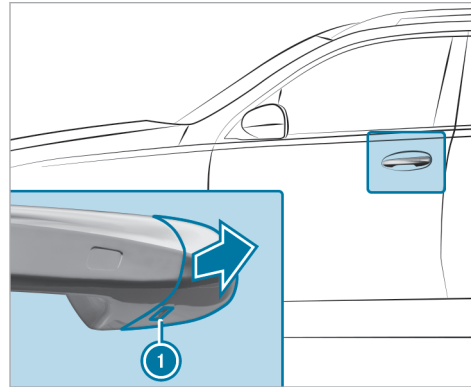

- ▶ Remove the mechanical key (→ page 78).
- ▶ Insert the mechanical key as far as it will go into opening ❶ in the cover.
- ▶ Pull and hold the door handle.
- ▶ Pull the cover on the mechanical key as straight as possible away from the vehicle until it releases.
- ▶ Release the door handle.

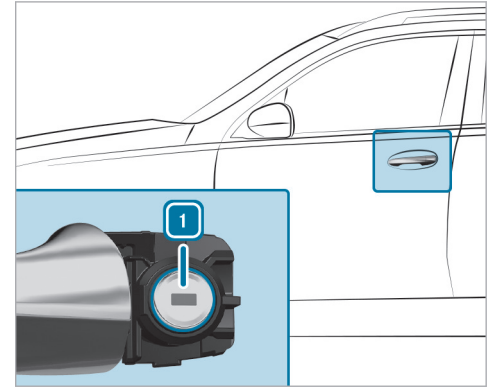

- ▶ **To unlock:** turn the mechanical key counter-clockwise to position 1.
- ▶ **To lock:** turn the mechanical key clockwise to position 1.
- ▶ Carefully press the cover onto the lock cylinder until it engages and is seated firmly.

Cargo compartment

Opening the tailgate

⚠ DANGER Risk of exhaust gas poisoning

Combustion engines emit poisonous exhaust gases such as carbon monoxide. Exhaust gases can enter the vehicle interior if the tailgate is open when the engine is running, especially if the vehicle is in motion.

- ▶ Always switch off the engine before opening the tailgate.
- ▶ Never drive with the tailgate open.

! **NOTE** Damage to the tailgate caused by obstacles above the vehicle

The tailgate swings rearwards and upwards when it is opened.

- ▶ Make sure that there is sufficient space behind and above the tailgate.

- ▶ If the tailgate is unlocked, pull the tailgate handle and release it again immediately.
- ▶ **Vehicles with HANDS-FREE ACCESS:** Make a kicking movement with your foot below the bumper (→ page 87).

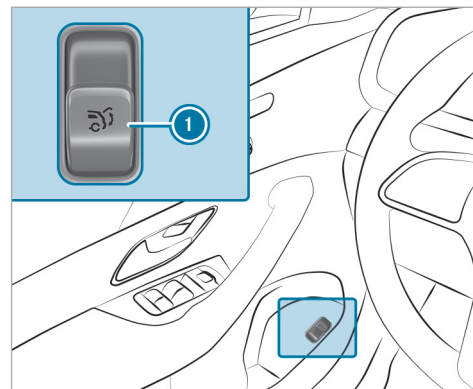

- ▶ Pull remote operating switch 1 until the tailgate opens.

or

- ▶ Press and hold the  button on the key.
- ▶ If the tailgate has stopped in an intermediate position, pull it upwards. Release it as soon as it begins to open.

If an obstacle obstructs the tailgate during the automatic opening process, blockage detection will stop the tailgate. The automatic blockage detection function is only an aid. It is not a substitute for your attentiveness.

Closing the tailgate

⚠ WARNING Risk of injury from unsecured items in the vehicle

If objects, luggage or loads are not secured or not secured sufficiently, they could slip, tip over or be thrown around and thereby hit vehicle occupants.

There is a risk of injury, particularly in the event of sudden braking or a sudden change in direction.

- ▶ Always stow objects in such a way that they cannot be thrown around.
- ▶ Before the journey, secure objects, luggage or loads against slipping or tipping over.

Observe the notes on loading the vehicle.

Notes on closing the tailgate: your vehicle is equipped with automatic key recognition. If a key belonging to the vehicle is detected in the vehicle, the tailgate will not be locked.

Note that the tailgate will not be locked in the following situation:

- You have locked the vehicle and close the tailgate while a key belonging to the vehicle is inside the vehicle.
- and
- A second key belonging to the vehicle is not detected outside the vehicle.

Automatic key recognition is only an aid and is not a substitute for your attentiveness.

- ▶ Before locking, ensure that at least one key belonging to the vehicle is outside the vehicle.
- ▶ **To close the tailgate:** pull the tailgate downwards slightly. Release it as soon as it begins to close.

⚠ WARNING Risk of becoming trapped during automatic closing of the tailgate

Body parts may become trapped. There may be people in the closing area.

- ▶ Make sure that nobody is in the vicinity of the closing area during the closing process.

Use one of the following options to stop the closing process:

- Press the  button on the SmartKey.
- Press or pull the remote operating switch on the driver's door.
- Press the closing or locking button on the tailgate.
- Pull the tailgate handle.

Vehicles with HANDS-FREE ACCESS: it is also possible to stop the closing process by making a kicking movement below the rear bumper.

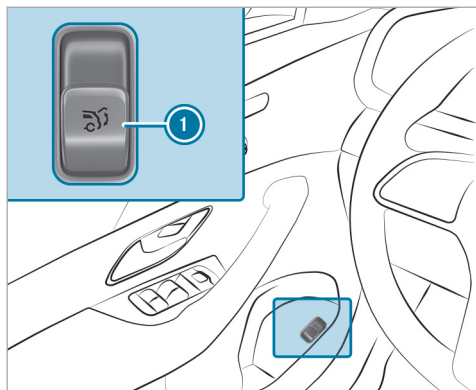

- ▶ Switch on the power supply or the vehicle.
- ▶ Push remote operating switch ❶ until the tailgate is fully closed.

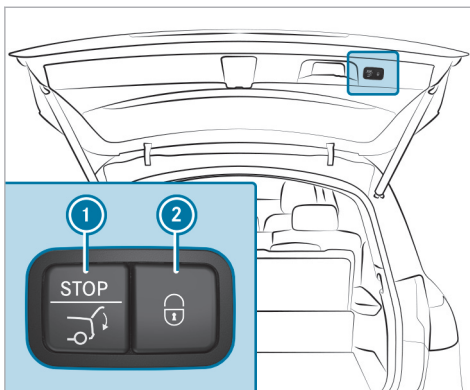

- ▶ Press closing button ❶ on the tailgate.

Vehicles with KEYLESS-GO

- ▶ Press locking button ❷ on the tailgate. If a key is detected outside the vehicle, the tailgate will close and the vehicle will be locked.
- ▶ Press and hold the  button on the key (with the key in the vicinity of the vehicle).

Vehicles with HANDS-FREE ACCESS

- ▶ Make a kicking movement with your foot below the bumper (→ page 87).

Automatic reversing function for the tailgate

The tailgate is equipped with automatic blockage detection with a reversing function. If a solid object hinders or restricts the tailgate when it is closing automatically, the tailgate will automatically open again slightly. Automatic blockage detection with a reversing function is only an aid. It is not a substitute for your attentiveness when you are closing the tailgate.

- ▶ During the closing process, make sure that no body parts are in the closing area.

⚠ WARNING Risk of becoming trapped despite reversing function

The reversing function will not react:

- To soft, light and thin objects, e.g. fingers
- Towards the end of the closing procedure

In these situations in particular, the reversing function cannot prevent someone being trapped.

- ▶ Ensure that no body parts are in the closing area.

If someone is trapped, either:

- Press the  button on the SmartKey.
- Press or pull the remote operating switch on the driver's door.
- Press the closing or locking button on the tailgate.
- Pull the tailgate handle.

HANDS-FREE ACCESS function

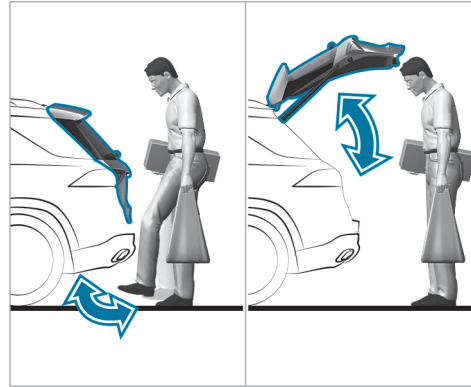

With HANDS-FREE ACCESS, you can open, close or stop the closing process of the tailgate by performing a kicking movement under the rear bumper.

The kicking movement triggers the opening or closing process alternately.

Observe the notes when opening (→ page 84) and closing (→ page 85) the tailgate.

- ⓘ Two warning tones sound when the tailgate is opening or closing.

⚠ WARNING Risk of burns caused by a hot exhaust system

The vehicle exhaust system can become very hot. If you use HANDS-FREE ACCESS, you could burn yourself by touching the exhaust system.

- ▶ Always ensure that you only make a kicking movement within the detection range of the sensors.

! **NOTE** Vehicle damage due to unintentional opening of the tailgate

- When using an automatic car wash
- When using a high pressure cleaner

- ▶ Deactivate the function of the SmartKey in these situations.

or

- ▶ Make sure that the SmartKey is at a minimum distance of 10 ft (3 m) away from the vehicle.

When making the kicking movement, make sure that you are standing firmly on the ground. You could otherwise lose your balance, e.g. on ice.

Observe the following notes:

- The key is behind the vehicle.
- Stand at least 12 in (30 cm) away from the vehicle while performing the kicking movement.
- Do not come into contact with the bumper while making the kicking movement.
- Do not carry out the kicking movement too slowly.
- The kicking movement must be towards the vehicle and back again.

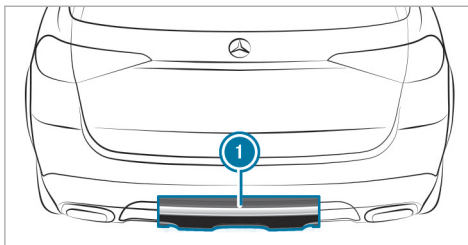

① Detection range of the sensors

If several consecutive kicking movements are not successful, wait ten seconds.

System limits

The system may be impaired or may not function in the following cases:

- The sensors are dirty, e.g. due to road salt or snow.
- The kicking movement is made using a prosthetic leg.

The tailgate can open or close unintentionally in the following situations:

- A person's arms or legs are moving in the sensor detection range, e.g. when polishing the vehicle or picking up objects.
- Objects are moved or placed behind the vehicle, e.g. the hose of a fuel dispenser, a charging cable or luggage
- Clamping straps, tarps or other coverings are pulled over the bumper.
- A protective mat with a length reaching over the trunk sill down into the detection range of the sensors is used.
- The protective mat is not secured correctly.
- Work is being done on the trailer hitch, trailers or rear bicycle racks.

Deactivate the function of the key (→ page 77) or do not carry the key about your person in such situations.

Limiting the opening angle of the tailgate

Activating the opening angle limiter

You can limit the opening angle of the tailgate in the top half of its opening range up to a point shortly before the end position.

- ▶ Stop the opening procedure of the tailgate at the desired position.
- ▶ Press and hold the closing button on the tailgate until you hear a short acoustic signal. The opening angle limiter will be activated. The tailgate will then stop in the stored position when opened.

To open the tailgate fully, pull the handle on the outside of the tailgate again after it has stopped automatically.

Deactivating the opening angle limiter

- ▶ Press and hold the closing button on the tailgate until two short acoustic signals sound.

Unlocking the tailgate with the emergency key

Requirements:

- The rear seat backrest has been folded forward.
- The cargo compartment cover has been removed.

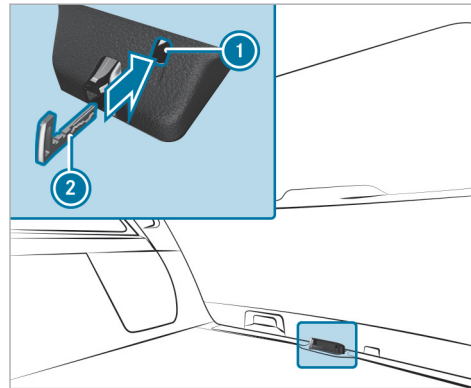

- ▶ Remove the emergency key (→ page 78).

- ▶ Insert emergency key ② into opening ① in the trim and push it in. The tailgate will be unlocked.

Side windows

Opening and closing the side windows

- ⚠ **WARNING** Risk of entrapment when opening a side window

When opening a side window, parts of the body could be drawn in or become trapped between the side window and window frame.

- ▶ When opening, make sure that nobody is touching the side window.
- ▶ If someone is trapped, release the button immediately or pull it in order to close the side window again.

- ⚠ **WARNING** Risk of becoming trapped when closing a side window

When closing a side window, body parts could be trapped in the closing area in the process.

- ▶ When closing, make sure that no body parts are in the closing area.
- ▶ If someone is trapped, release the button immediately or press the button in order to reopen the side window.

⚠ WARNING Risk of becoming trapped when children operate the side windows

Children could become trapped if they operate the side windows, particularly when unattended.

- ▶ Activate the child safety lock for the rear passenger compartment side windows.
- ▶ When leaving the vehicle, always take the SmartKey with you and lock the vehicle.
- ▶ Never leave children unattended in the vehicle.

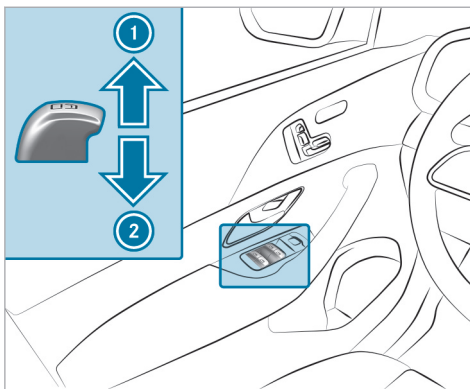

Requirements:

- The power supply or the vehicle has been switched on.



- ① Closing
- ② Opening

The buttons on the driver's door take precedence.

- ▶ **To start automatic operation:** press the  button beyond the point of resistance or pull and release it.
- ▶ **To interrupt automatic operation:** press or pull the  button again.

When the vehicle is switched off, you can continue to operate the side windows.

This function is available for around four minutes or until a front door is opened.

- i Vehicles with electric sunblinds on the left and right rear doors:** The buttons for the rear side windows also open and close the roller sunblinds (→ page 97).

Automatic reversing function of the side windows

If an obstacle impedes a side window during the closing process, the side window will open again automatically. The automatic reversing function is only an aid and is not a substitute for your attentiveness.

- ▶ During the closing process, make sure that no body parts are in the closing area.

⚠ WARNING Risk of becoming trapped despite there being reversing protection on the side window

The reversing function does not react:

- To soft, light and thin objects, e.g. fingers.

- During resetting.

The reversing function cannot prevent someone from becoming trapped in these situations.

- ▶ During the closing process, make sure that no body parts are in the closing area.
- ▶ If someone becomes trapped, press the  button to open the side window again.

Convenience opening (ventilating the vehicle before starting a journey)

⚠ WARNING Risk of entrapment when opening a side window

When opening a side window, parts of the body could be drawn in or become trapped between the side window and window frame.

- ▶ When opening, make sure that nobody is touching the side window.

- ▶ Release the button immediately if somebody becomes trapped.

Requirements

- The SmartKey is in the immediate vicinity of the vehicle.

- ▶ Press and hold the  button on the SmartKey.

The following functions are performed:

- The vehicle is unlocked.
- The side windows are opened.
- The sliding sunroof is opened.
- The panoramic sliding roof is opened.
- The seat ventilation of the driver's seat is switched on.

- ① If the roller sunblind of the panoramic sliding sunroof is closed, the roller sunblind is opened first.
- ① If the roller sunblinds of the rear doors are closed, the roller sunblinds are opened first.

- ▶ **To interrupt convenience opening:** release the  button.

- ▶ **To continue convenience opening:** press and hold the  button again.

Convenience closing (closing the vehicle from outside)



⚠ WARNING Risk of entrapment due to not paying attention during convenience closing

When the convenience closing feature is operating, parts of the body could become trapped in the closing area of the side window and the sliding sunroof.

- ▶ When the convenience closing feature is operating, monitor the entire closing process and make sure that no body parts are in the closing area.

Requirements

- The key is in the immediate vicinity of the vehicle.

- ▶ Press and hold the  button on the key. The following functions are performed:
 - The vehicle is locked.
 - The side windows are closed.
 - The sliding sunroof is closed.
 - The panorama roof with power tilt/sliding panel is closed.
 - ▶ **To interrupt convenience closing:** release the  button.
 - ▶ **To continue convenience closing:** press and hold the  button again.
- i** Convenience closing also functions with KEY-LESS-GO (→ page 81).

Resolving problems with the side windows

⚠ WARNING Risk of becoming trapped or fatally injured if reversing protection is not activated

If you close a side window again immediately after it has been blocked, the side window will

close with increased or maximum force. The reversing function is then not active and body parts may become trapped.

- ▶ Make sure that no parts of the body are in the closing area.
- ▶ To stop the closing process, release the button or press the button again to reopen the side window.

A side window cannot be closed and you cannot see the cause.

- ▶ Check to see whether any objects are in the window guide.
- ▶ Adjust the side windows.

Adjusting the side windows

If a side window is obstructed during closing and reopens again immediately:

- ▶ Immediately after this, pull and hold the corresponding button again until the side window

has closed and hold the button for at least one more second (re-adjustment). The side window will be closed without the automatic reversing function.

If the side window is obstructed again and reopens again immediately:

- ▶ Immediately after this, pull and hold the corresponding button again until the side window has closed and hold the button for at least one more second (follow-up adjustment). The side window will be closed without the automatic reversing function.

The side windows cannot be opened or closed using the convenience opening feature.

Possible causes are:

- The key battery is weak or discharged.
- ▶ Check the battery using the indicator lamp (→ page 76).
 - ▶ Replace the key battery, if necessary (→ page 78).

Sliding sunroof

Opening and closing the sliding sunroof

i The term "sliding sunroof" also refers to the panorama roof with power tilt/sliding panel.

⚠ WARNING Risk of becoming trapped when the sliding sunroof is being opened and closed

Body parts may become trapped in the range of movement.

- ▶ During opening and closing, make sure that no body parts are in the range of movement.
- ▶ Release the button immediately if somebody becomes trapped.

or

- ▶ Briefly press the button in any direction during automatic operation. The opening or closing process will be stopped.

⚠ WARNING Risk of becoming trapped if the sliding sunroof is operated by children

Children operating the sliding sunroof could get caught in the moving parts, particularly if unattended.

- ▶ Never leave children unattended in the vehicle.
- ▶ When leaving the vehicle, always take the key with you and lock the vehicle.

⚠ WARNING Risk of becoming trapped when the roller sunblind is being opened and closed

Body parts may become trapped between the roller sunblind and frame or sliding roof.

- ▶ When opening or closing, make sure that no body parts are in the roller sunblind's range of movement.
- ▶ Release the button immediately if somebody becomes trapped.

or

- ▶ Briefly press the button in any direction during automatic operation. The opening or closing process will be stopped.

! NOTE Malfunction due to snow and ice

Snow and ice may cause the sliding sunroof to malfunction.

- ▶ Open the sliding sunroof only if it is free of snow and ice.

! NOTE Damage caused by protruding objects

Objects that protrude from the sliding sunroof may damage the seals.

- ▶ Do not allow anything to protrude from the sliding sunroof.

NOTE Damage to the sliding sunroof when a roof luggage rack is installed

When a roof luggage rack is installed, raising or opening the sliding sunroof may be restricted.

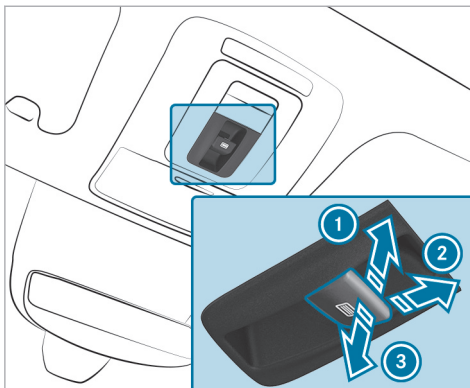

- ▶ Check whether the sliding sunroof can be raised or opened when a roof luggage rack is installed.
- ▶ If in doubt, do not raise or open the sliding sunroof.



- ① Raise
- ② Open
- ③ Close/lower

Use the  button to operate the panorama roof with power tilt/sliding panel and the roller sunblind.

The panorama roof with power tilt/sliding panel can be operated only when the roller sunblind is open. **Exception:** ventilating the vehicle interior

- ▶ Check whether the sliding sunroof can be raised or opened when a roof luggage rack is installed.
- ▶ **To start automatic operation:** press the  button beyond the point of resistance or pull and release it.
- ▶ **To interrupt automatic operation:** briefly press the  button in any direction. The opening/closing process will be stopped.

Vehicles with a panorama roof with power tilt/sliding panel: the automatic raising feature is available only when the sliding sunroof is closed or raised.

Vehicles without a panorama roof with power tilt/sliding panel: the automatic opening and raising features are available only when the sliding sunroof is closed.

- ▶ **To ventilate the vehicle interior:** raise the sliding sunroof. The roller sunblind will open slightly.

Operating the roller sunblind for the sliding sunroof from the rear passenger compartment

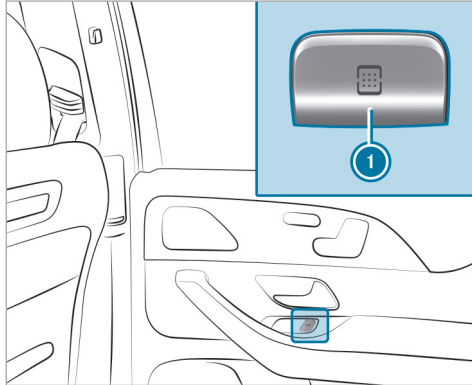

▶ **To open:** press button ①.

▶ **To close:** pull button ①.

① When the sliding sunroof is open, it will close first. To close the roller sunblind, you will need to pull button ① again.

If you press or pull button ① beyond the point of resistance, you will start automatic operation in the direction in question. You can stop automatic operation by pushing or pulling the button again.

Automatic reversing function of the sliding sunroof

If an obstacle obstructs the sliding sunroof during the closing process, the sliding sunroof will open again automatically. The automatic reversing function is only an aid and is not a substitute for your attentiveness.

▶ During the closing process, make sure that no body parts are in the closing area.

⚠ WARNING Risk of becoming trapped despite the reversing function being active

In particular, the reversing function does not react:

- To soft, light and thin objects, e.g. fingers.
- Towards the end of the closing procedure.
- During resetting.

- ▶ During the closing process, make sure that no body parts are in the closing area.
 - ▶ Release the button immediately if somebody becomes trapped.
- or
- ▶ Briefly press the button in any direction during automatic operation. The closing process will be stopped.

Automatic reversing function of the roller sunblind

If an obstacle obstructs the roller sunblind during the closing process, the roller sunblind will open again automatically. The automatic reversing function is only an aid and is not a substitute for your attentiveness.

- ▶ When closing the roller sunblind, make sure that no body parts are in the area of movement.

⚠ WARNING Risk of becoming trapped despite reversing function

In particular, the reversing function does not react to soft, light and thin objects, e.g. fingers.

- ▶ When closing the roller sunblind, make sure that no body parts are in the range of movement.
- ▶ Release the button immediately if somebody becomes trapped.

or

- ▶ Briefly press the button in any direction during the automatic closing process. The closing process will be stopped.

Automatic functions of the sliding sunroof

- ① The term "sliding sunroof" also refers to the panoramic sliding sunroof.

Rain closing function when driving

Vehicles with a panoramic sliding sunroof: if it starts to rain, the raised sliding sunroof will auto-

matically be lowered while the vehicle is in motion.

Automatic lowering function

Vehicles with a panoramic sliding sunroof: if the sliding sunroof is raised at the rear, it will automatically be lowered slightly at higher speeds. At low speeds, it will be raised again automatically.

⚠ WARNING Risk of becoming trapped by automatic lowering of the sliding sunroof

At higher speeds, the raised sliding sunroof will automatically be lowered slightly at the rear.

- ▶ Make sure that nobody reaches into the sliding sunroof's range of movement while the vehicle is in motion.
- ▶ If somebody becomes trapped, briefly push the sliding sunroof button forwards or backwards.

- ① By pushing or pulling the  button, you can interrupt the automatic functions "Rain closing function when driving" and "Automatic lowering".

Rectifying problems with the sliding sunroof

⚠ WARNING Risk of becoming trapped or fatal injuries when the sliding sunroof is closed again

If the sliding sunroof is closed again immediately after it has been blocked or reset, it will close with increased force.

- ▶ Make sure that no parts of the body are in the closing area.
- ▶ Release the button immediately if somebody becomes trapped.

or

- ▶ Briefly press the button in any direction during the automatic closing process. The closing process will be stopped.

The sliding sunroof cannot be closed and you cannot see the cause.

- ① The term "sliding sunroof" also refers to the panorama roof with power tilt/sliding panel.

If the sliding sunroof is obstructed during closing and reopens again slightly:

- ▶ Immediately after automatic reversing, pull and hold the  button down again to the point of resistance until the sliding sunroof is closed. The sliding sunroof will be closed with increased force.



If the sliding sunroof is obstructed again and opens again slightly:

- ▶ Repeat the previous step. The sliding sunroof will be closed again with increased force.

Vehicles without a panorama roof with power tilt/sliding panel: The sliding sunroof is not operating smoothly.

- ▶ Reset the sliding sunroof.



Resetting the sliding sunroof

- ▶ Push the  button up to the point of resistance repeatedly until the sliding sunroof is fully open.
- ▶ Press the  button for another second.
- ▶ Close the sliding sunroof.

Vehicles with a panorama roof with power tilt/sliding panel: The sliding sunroof or the roller sunblind is not operating smoothly.

- ▶ Reset the sliding sunroof and the roller sunblind.

Resetting the sliding sunroof and the roller sunblind

- ▶ Pull and hold the  button little by little until the sliding sunroof is fully closed.
- ▶ Pull and hold the  button little by little until the roller sunblind is fully closed.
- ▶ Use automatic operation to fully open and then close the sliding sunroof.

Roller sun blinds

Extending or retracting the roller sunblinds on the rear side windows

⚠ WARNING Risk of becoming trapped when extending or retracting the roller sunblind

Body parts could become trapped in the sweep of the roller sunblind when it is being extended or retracted.

- ▶ Make sure that no body parts are in the sweep of the roller sunblind when it is being extended or retracted.
- ▶ If someone becomes trapped, briefly press the button in the opposite direction. The opening or closing process will briefly be stopped. The roller sunblind will then return to its starting position.

! NOTE Damage caused by objects

Objects can cause the roller sunblind to malfunction.

- ▶ Ensure that the roller sunblind can move freely.

The roller sunblinds for the rear side windows can be operated with the buttons for the side windows in the driver's door and in the rear doors.

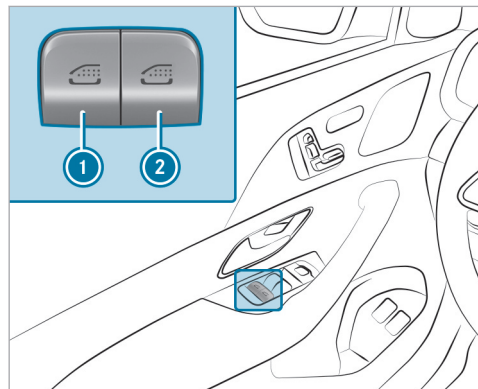

- ① Rear left side window/roller sunblind
- ② Rear right side window/roller sunblind

- ▶ **To close fully:** briefly pull the corresponding button when the side window is closed.
- ▶ **To open fully:** briefly press the corresponding button.

Anti-theft protection

Function of the immobilizer

The immobilizer prevents your vehicle from being started without the correct key.

The immobilizer will automatically be activated when the vehicle is switched off, and deactivated when the vehicle is switched on.

When leaving the vehicle, always take the key with you and lock the vehicle. Anyone can start the vehicle if a valid key has been left inside the vehicle.

- ⓘ In the event the engine cannot be started (yet the vehicle's battery is charged), the system will not be operational. Contact an authorized Mercedes-Benz center or call 1-800-FOR-MERCEDES (in the USA) or 1-800-387-0100 (in Canada).

ATA (anti-theft alarm system)

Function of the ATA system

If the ATA system is activated, a visual and audible alarm is triggered in the following situations:

- when a door is opened
- when the tailgate is opened
- when the hood is opened
- when interior protection is triggered (→ page 100)
- when the tow-away alarm is triggered (→ page 99)

The ATA system is activated automatically after approximately ten seconds in the following situations:

- after locking the vehicle with the key
- after locking the vehicle using KEYLESS-GO

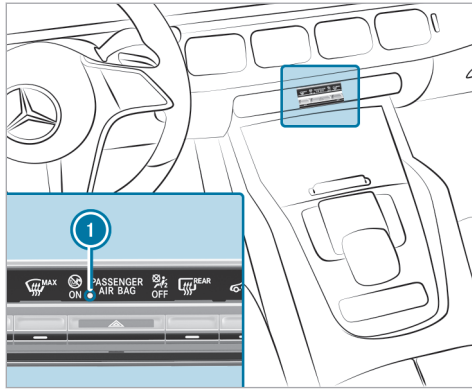

Indicator lamp ❶ flashes when the ATA system is activated.

The ATA system is deactivated automatically in the following situations:

- after unlocking the vehicle with the key
- after unlocking the vehicle using KEYLESS-GO

- after pressing the start/stop button with the key in the stowage compartment (→ page 173)

❶ If the battery is heavily discharged, the burglar alarm system is automatically deactivated to facilitate the next engine start.

Deactivating the ATA

▶ Press the ,  or  button on the key.

or

▶ Press the start/stop button with the key in the stowage compartment (→ page 173)

Deactivating the alarm using KEYLESS-GO

▶ Grasp the outside door handle with the key outside the vehicle.

Function of the tow-away alarm

❶ This function may not be available in all countries.

An audible and visual alarm will be triggered if an alteration to your vehicle's angle of inclination is detected while the tow-away alarm is armed.



The tow-away alarm will automatically be armed after approximately 60 seconds:

- after the vehicle is locked with the key
- after the vehicle is locked using KEYLESS-GO

The tow-away alarm will be armed only when the following components are closed:

- Doors
- Tailgate

The tow-away alarm will automatically be deactivated:

- after the  or  button on the key is pressed
- after the start/stop button is pressed with the key in the stowage compartment (→ page 173)
- after the vehicle is unlocked using KEYLESS-GO
- when HANDS-FREE ACCESS is used

Information on collision detection on a parked vehicle (→ page 226).

Arming/deactivating tow-away alarm

Multimedia system:

↪  ▶▶ Settings ▶▶ Vehicle
▶▶ Opening/closing ▶▶ Vehicle Protection

▶ Arm or deactivate **Tow-away Protection**.

Tow-away alarm is armed again in the following cases:

- The vehicle is unlocked again.
- A door is opened.
- The vehicle is locked again.

Function of interior protection

 This function may not be available in all countries.

When interior protection is armed, a visual and audible alarm is triggered if movement is detected in the vehicle interior.



Interior protection is armed automatically after approximately ten seconds:

- after locking the vehicle with the key
- after locking the vehicle using KEYLESS-GO

Interior protection is armed only when the following components are closed:

- Doors
- Tailgate

Interior protection is automatically deactivated:

- after pressing the  or  button on the key
- after pressing the start/stop button with the key in the stowage compartment (→ page 173)
- after unlocking the vehicle using KEYLESS-GO
- when using HANDS-FREE ACCESS

The following situations can lead to a false alarm:

- when there are moving objects such as mascots in the vehicle interior
- if a side window is open

- if the sunroof is open
- if the panorama roof with power tilt/sliding panel is open

Arming/deactivating interior protection

Multimedia system:

↪  ▶▶ Settings ▶▶ Vehicle
▶▶ Opening/closing ▶▶ Vehicle Protection

▶ Arm or deactivate **Interior Motion Sensor**.

Interior protection is armed again in the following cases:

- The vehicle is unlocked again.
- A door is opened.
- The vehicle is locked again.

Notes on the correct driver's seat position

⚠ WARNING Risk of accident due to adjusting the vehicle settings while the vehicle is in motion

You could lose control of the vehicle in the following situations in particular:

- If you adjust the driver's seat, the head restraint, the steering wheel or the mirror while the vehicle is in motion
 - If you fasten your seat belt while the vehicle is in motion
- ▶ Before starting the engine: In particular, adjust the driver's seat, head restraint, steering wheel and mirror, and fasten your seat belt.

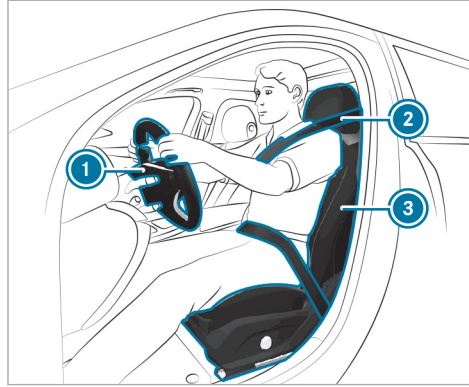

Ensure the following when adjusting steering wheel ①, seat belt ② and driver's seat ③:

- You are sitting as far away from the driver's air bag as possible, taking the following points into consideration:
- You are sitting in an upright position
- Your thighs are slightly supported by the seat cushion

- Your legs are not fully extended and you can depress the pedals properly
- The back of your head is supported at eye level by the center of the head restraint
- You can hold the steering wheel with your arms slightly bent
- You can move your legs freely
- You can see all the displays on the instrument cluster clearly
- You have a good overview of the traffic conditions
- Your seat belt sits snugly against your body and passes across the center of your shoulder and across your hips in the pelvic area

Notes on grab handles

⚠ WARNING Risk of injury due to excessive load on the grab handles

If you apply your full body weight to the grab handle or pull it abruptly, the grab handle may

be damaged or come loose from its anchorage. This may result in injuries.

- ▶ Use the grab handles only to stabilize the seating position or to assist in getting in and out of the seat.

Seats

Adjusting the front seat

⚠ WARNING Risk of becoming trapped if the seats are adjusted by children

Children could become trapped if they adjust the seats, particularly when unattended.

- ▶ When leaving the vehicle, always take the SmartKey with you and lock the vehicle.
- ▶ Never leave children unattended in the vehicle.

You can adjust the seats when the vehicle is switched off.

⚠ WARNING Risk of becoming trapped when adjusting the seat

When you adjust a seat, you or other vehicle occupants could become trapped, e.g. on the seat guide rail.

- ▶ When adjusting a seat, make sure that no one has any part of their body within the sweep of the seat.

Observe the safety notes on "Air bags" and "Children in the vehicle".

⚠ WARNING Risk of accident due to adjusting the vehicle settings while the vehicle is in motion

You could lose control of the vehicle in the following situations in particular:

- If you adjust the driver's seat, the head restraint, the steering wheel or the mirror while the vehicle is in motion
- If you fasten your seat belt while the vehicle is in motion

- ▶ Before starting the vehicle: in particular, adjust the driver's seat, head restraint, steering wheel and mirror, and fasten your seat belt.

⚠ WARNING Risk of becoming trapped if the seat height is adjusted carelessly

If you adjust the seat height carelessly, you or other vehicle occupants could be trapped and thereby injured.

Children in particular could accidentally press the electrical seat adjustment buttons and become trapped.

- ▶ While moving the seats, make sure that hands or other body parts do not get under the lever assembly of the seat adjustment system.

▲ WARNING Risk of injury due to head restraints not being installed or being adjusted incorrectly

If head restraints have not been installed or have not been adjusted correctly, there is an increased risk of injury in the head and neck area, e.g. in the event of an accident or when braking.

- ▶ Always drive with the head restraints installed.
- ▶ Before driving off, make sure for every vehicle occupant that the center of the head restraint supports the back of the head at about eye level.

Do not rotate the head restraints of the front and rear seats. Otherwise, you will not be able to adjust the height and angle of the head restraints correctly.

Adjust the head restraint fore-and-aft position so that it is as close as possible to the back of your head.

▲ WARNING Risk of injury or death due to an incorrect seat position

The seat belt does not offer the intended level of protection if you have not moved the seat backrest to an almost vertical position.

In particular, you could slip beneath the seat-belt and become injured.

- ▶ Adjust the seat properly before beginning your journey.
- ▶ Always ensure that the seat backrest is in an almost vertical position and that the shoulder belt is routed across the center of your shoulder.

▲ WARNING Risk of injury due to excessive load on the grab handles

If you apply your full body weight to the grab handle or pull it abruptly, the grab handle may be damaged or come loose from its anchorage. This may result in injuries.

- ▶ Use the grab handles only to stabilize the seating position or to assist in getting in and out of the seat.

▲ WARNING Risk of potentially fatal injuries due to objects trapped under the front passenger seat

Objects trapped under the front passenger seat may interfere with the function of the automatic front passenger air bag shutoff or damage the system.

- ▶ Do not stow any objects under the front passenger seat.
- ▶ When the front passenger seat is occupied, ensure that no objects have become trapped beneath the front passenger seat.

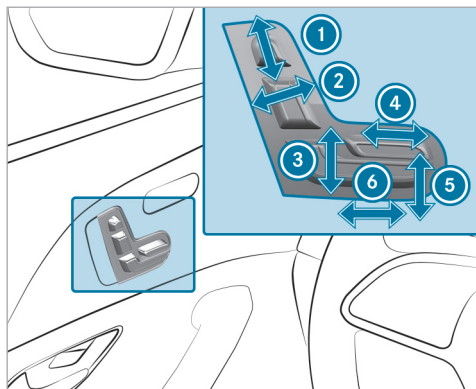

- ① Head restraint height
- ② Seat backrest inclination
- ③ Seat height
- ④ Seat cushion length
- ⑤ Seat cushion inclination
- ⑥ Seat fore-and-aft position

► Save the settings with the memory function (→ page 118).

Adjusting the front passenger seat electrically from the driver's seat

⚠ WARNING Risk of injury or death due to the front seat being positioned too close to the cockpit

The front airbags can also injure the occupants in the front of the vehicle.

- Always adjust the front seats so they are as far away as possible from the front airbags.
- In addition, observe the notes on correct seat adjustment.

Requirements:

- The power supply is switched on.

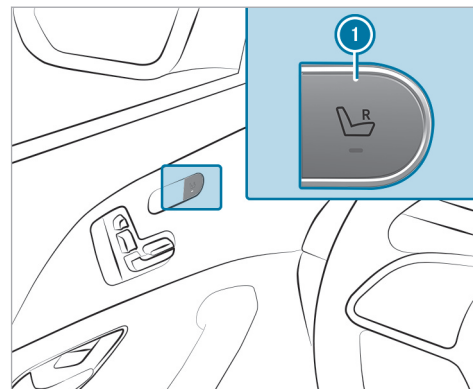

You can call up the following functions for the front passenger seat:

- Seat adjustment
- Seat heating
- Seat ventilation
- Memory function

- ▶ **To select the front passenger seat:** press button ❶.
When the indicator lamp lights up, the front passenger seat is selected.
- ▶ Adjust the front passenger seat using the buttons on the driver's side door operating unit.
- ▶ **To select the driver's seat:** press button ❶ again.
When the indicator lamp goes out, the driver's seat has been selected.

Adjusting the 4-way lumbar support

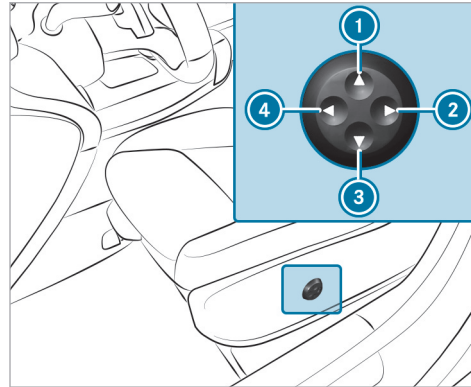

- ❶ Higher
- ❷ Softer
- ❸ Lower
- ❹ Firmer

- ▶ Use buttons ❶ to ❹ adjust the contour of the backrest.

Adjusting the rear seat electrically

! **NOTE** Damage to the rear seat armrest when folding the center seat backrest forward

If the rear seat armrest is folded down, it can be damaged when the center seat backrest is folded forward.

- ▶ Fold the rear seat armrest upwards before folding the center seat backrest forward.

The middle seat backrest is adjusted together with the left seat.

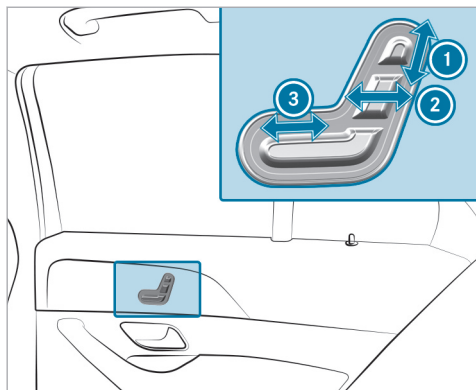

- ① Head restraint height
- ② Seat backrest inclination
- ③ Seat fore-and-aft position

Folding the rear seats forwards electrically

⚠ WARNING Risk of becoming trapped when adjusting the seats

When you adjust a seat, you may trap yourself or a vehicle occupant.

- ▶ When adjusting a seat, make sure that no one has any body parts in the sweep of the seat.

⚠ WARNING Risk of an accident because the seat backrest is not engaged

The seat backrest may fold forwards.

There is a risk of the following, in particular:

- The vehicle occupant may be pressed against the seat belt. The seat belt cannot protect as intended and could cause additional injury.
- A child restraint system will no longer be properly supported or positioned and will no longer fulfill its function as intended.

- The seat backrest will not be able restrain objects or goods in the cargo compartment.

Always ensure that the seat backrest is engaged, especially:

- Before persons travel in the vehicle while sitting on a seat with the easy entry and exit feature
- After the seat backrest has been adjusted
- After the easy entry and exit feature has been used
- After the cargo compartment enlargement has been folded forwards

⚠ WARNING Risk of injury due to seat backrests folded forwards

If the seat backrest of the rear seat is folded forwards, persons in the third row of seats may hit parts of the seat mechanism, especially in the event of an accident, braking maneuver or abrupt change of direction.

- ▶ If there is a person in the third row of seats, the rear seat in front of them must be folded back to the driving position before the journey begins.
- ▶ Persons in the third row of seats should not rest their legs on a seat backrest that has been folded forwards.

Always ensure that all vehicle occupants have their seat belts fastened correctly and are sitting properly. Particular attention must be paid to children.

If you no longer require the seat backrest to be folded down for loading or for getting in and out, fold it back into place.

⚠ WARNING Risk of becoming trapped if the seat is not engaged

The seat does not engage when folded forwards. The seat can fold backwards unexpectedly, e.g. when accelerating, braking or in the event of an abrupt change of direction or an accident.

People in the seat's sweep can become trapped.

- ▶ If a seat is folded forwards, always fold it back before driving off.
- ▶ Make sure that the seat is engaged.

To get in and out, you can fold the seats on the second row of seats forwards in vehicles with a third row of seats. In this case, the center seat folds forwards and backwards together with the left-hand seat in vehicles with a center seat backrest.

Requirements

- The area into which the seat is folded is clear.
- The seat has been folded up (→ page 125).
- Vehicles with comfort seating: the center armrest is folded up.
- Vehicles with an extended center console: the stowage compartment in the center console is closed.
- Vehicles with a center seat backrest: the center seat backrest is in an upright position (→ page 122).

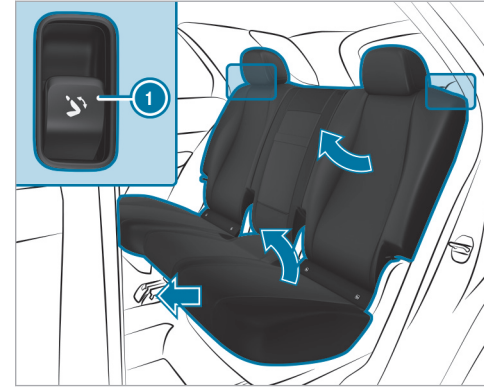

- ▶ **To fold the seat into the front position:** briefly pull on button ①. The head restraint will move downwards. The seat backrest will move into the front position. The seat fore-and-aft adjustment will move forwards until the seat is unlocked. The seat will then tip forwards.

- ▶ **To fold the seat back:** press and hold button ① until the rear seat engages audibly. The seat will tilt downwards and stop in the front position. The seat backrest will remain in the cargo position.
- ▶ To interrupt the folding process, release button ①. To continue the folding procedure, press and hold button ① again.

If a seat on the second row of seats is not engaged, this will be shown on the multifunction display on the instrument cluster.

- ▶ Set the seat backrest inclination and seat fore-and-aft adjustment using the buttons on the door operating unit.
- ① To increase the size of the cargo compartment, you can move the seat backrests into the trunk floor position (→ page 122).

Folding the rear seats forwards mechanically (emergency release)

The release loops are located on the outer sides and rear sides of the seats on the second row of seats.

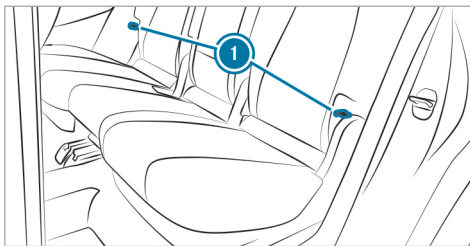

Side release loops

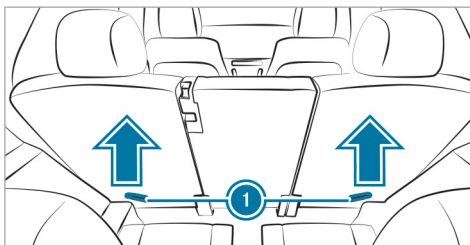

Release loops on the rear sides

- ▶ Pull one of release loops ①.

- ▶ Fold the seat backrest forwards.
- ▶ Before commencing your journey, make sure that the seat backrest and the rear bench seat are engaged.

Head restraints

Adjusting the front seat head restraints manually

⚠ WARNING Risk of accident due to adjusting the vehicle settings while the vehicle is in motion

You could lose control of the vehicle in the following situations in particular:

- If you adjust the driver's seat, the head restraint, the steering wheel or the mirror while the vehicle is in motion
 - If you fasten your seat belt while the vehicle is in motion
- ▶ Before starting the engine: In particular, adjust the driver's seat, head restraint,

steering wheel and mirror, and fasten your seat belt.

⚠ WARNING Risk of injury due to head restraints not being installed or being adjusted incorrectly

If head restraints have not been installed or have not been adjusted correctly, there is an increased risk of injury in the head and neck area, e.g. in the event of an accident or when braking.

- ▶ Always drive with the head restraints installed.
- ▶ Before driving off, make sure for every vehicle occupant that the center of the head restraint supports the back of the head at about eye level.

Do not rotate the head restraints of the front and rear seats. Otherwise, you will not be able to adjust the height and angle of the head restraints correctly.

Adjust the head restraint fore-and-aft position so that it is as close as possible to the back of your head.

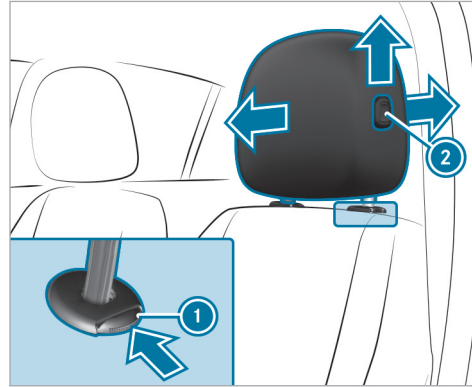

- ▶ **To raise:** pull the head restraint up.
- ▶ **To lower:** press release knob ① in the direction of the arrow and push the head restraint down.

- ▶ **To move forward:** press release knob ② and pull the head restraint forward.
- ▶ **To move backwards:** press release knob ② and push the head restraint backwards.

Adjusting the front seat luxury head restraints manually

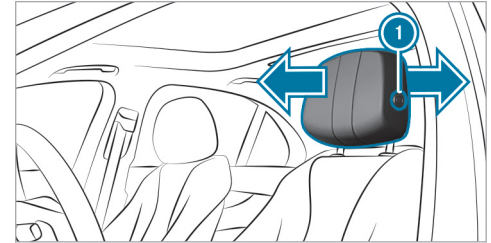

- ▶ **To move forward:** press release knob ① and pull the head restraint forward.
- ▶ **To move backwards:** press release knob ① and push the head restraint backwards.

Adjusting the head restraints of the rear seats manually

Depending on the vehicle equipment, you can adjust the head restraints in the rear passenger compartment.

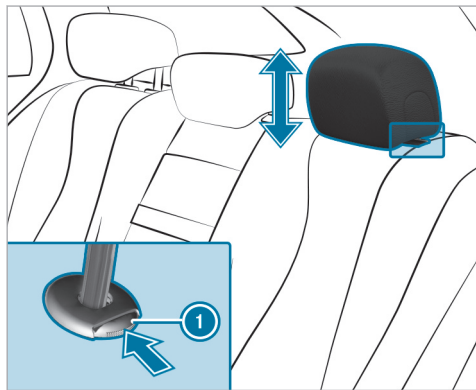

- ▶ **To raise:** pull the head restraint up.
- ▶ **To lower:** press release knob ① in the direction of the arrow and push the head restraint down.

Vehicles with a third row of seats

The head restraints on the third row of seats have a usage position and a non-usage position. The usage position is the extended, top position in which the head restraint engages; the non-usage position is the bottom, retracted position of the head restraint. If the seats on the third row of seats are being used, the head restraint must be in the top, engaged usage position.

- ▶ **If the third row of seats is occupied:** move the head restraints to the very top and have them engage there.
- ▶ **If the third row of seats is not occupied:** move the head restraints to the very bottom.

Installing/removing the rear seat head restraints

Removing

Depending on the vehicle equipment, you can remove the head restraints in the rear passenger compartment.

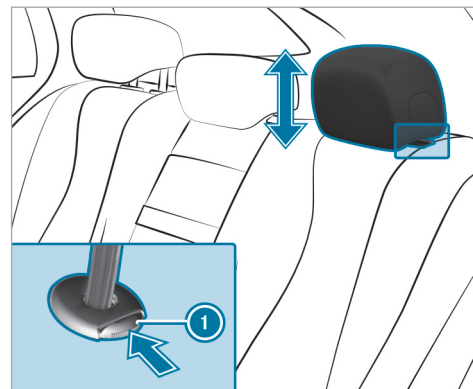

- ▶ Release the rear seat backrest and fold it forwards slightly (→ page 122).
- ▶ Pull the head restraint upwards as far as it will go.
- ▶ Push release knob ① in the direction of the arrow and pull out the head restraint.

Installing

- ▶ Insert the head restraint such that the notches on the bar are on the left when viewed in the direction of travel.
- ▶ Push the head restraint down until it engages.
- ▶ Fold the rear seat backrest back until it engages.

Configuring the seat settings

Multimedia system:

→  ▶▶ Comfort ▶▶ Seat

Adjusting the air cushions

- ▶ In the corresponding menu, adjust the air cushions for **Lumbar** or **Side Bolsters**.

Setting the seat heating balance

- ▶ Select **Heating Settings**.
- ▶ Select **Seat Heating Balance**.
- ▶ Adjust the heat distribution for the desired seat.

Setting automatic seat adjustment

⚠ WARNING Risk of becoming trapped during adjustment of the driver's seat after calling up a driver profile

Selecting a user profile may trigger an adjustment of the driver's seat to the position saved under the user profile. You or other vehicle occupants could be injured in the process.

- ▶ Make sure that when the position of driver's seat is being adjusted using the multimedia system, no people or body parts are in the seat's range of movement.

If there is a risk of someone becoming trapped, immediately stop the adjustment process by:

- ▶ a) Pressing the warning message on the central display.
- or
- ▶ b) Pressing a position button of the memory function or a seat adjustment switch in the driver's door.
The adjustment process is stopped.

Multimedia system:

→  ▶▶ Comfort ▶▶ Seat
▶▶ Automatic Seat Positioning

Manually adjusting driver's seat and steering wheel position to body size

The vehicle calculates a suitable driver's seat and steering wheel position on the basis of the driver's body size and sets this directly.

- ▶ **To set the unit of measurement:** select **cm** or **ft/in**.
 - ▶ Set the size using the scale.
 - ▶ Select **Start Positioning**.
- The driver's seat and steering wheel position is adjusted to the body size that has been set.



i You can also configure these settings via the Mercedes me user account for your user profile. By synchronizing the profiles in the vehicle and the Mercedes me connect profiles, you can carry over these settings for your vehicle. Further information about synchronizing user profiles .

- ❶ If the driver's seat and steering wheel position calculated by the vehicle is not practical or comfortable, it can be manually adapted at any time via the control buttons. The outside mirrors are not set via this function. Instead, they have to be set manually via the operating switches.

Selecting a massage program for the front seats

Multimedia system:

→  >> Comfort >> Massage

- ▶ Select a massage program .
- ▶ Start the program for the desired seat .
- ▶ **To set the relaxation intensity:** switch **Intensive** on or off .
- ▶ **To stop the vitalizing movement:** select .

- ❶ The availability of this function is dependent on the vehicle's equipment.

Resetting seat settings

Multimedia system:

→  >> Comfort >> Seat

- ▶ Select **Reset**.
- ▶ Select  for the desired seat. The settings for the selected seat are reset.

Switching the seat heating on/off

⚠ WARNING Risk of burns due to repeatedly switching on the seat heating

Repeatedly switching on the seat heating can cause the seat cushion and seat backrest padding to become very hot.

In particular, the health of persons with limited temperature sensitivity or a limited ability to react to high temperatures may be affected or they may even suffer burn-like injuries.

- ▶ Do not repeatedly switch on the seat heating.

To protect against overheating, the seat heating may be temporarily deactivated after it has been switched on repeatedly.

! **NOTE** Damage to the seats caused by objects or documents when the seat heating is switched on

When the seat heating is switched on, overheating may occur due to objects or documents placed on the seats, e.g. seat cushions or child seats. This could cause damage to the seat surface.

- ▶ Make sure that no objects or documents are on the seats when the seat heating is switched on.

Requirements

- The power supply is switched on.

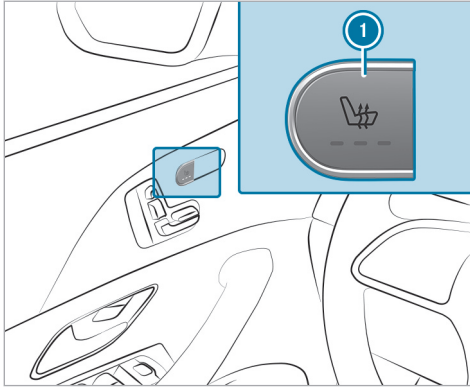

Seat heating in the cockpit

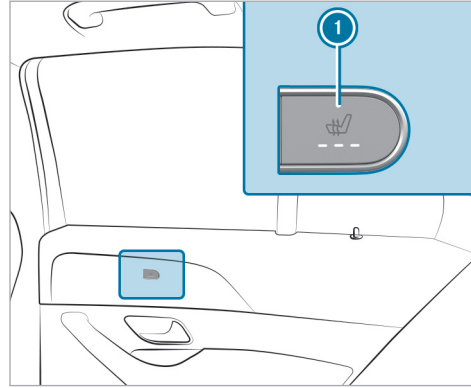

Seat heating in the rear passenger compartment

- ▶ Press button ❶ repeatedly until the desired heating level is set. Depending on the heating level, up to three indicator lamps will light up. If all indicator lamps are off, the seat heating is switched off.
- ❶ The seat heating will automatically switch down from the three heating levels after 8, 10

and 20 minutes until the seat heating is switched off.

Setting the panel heating

Multimedia system:

- ▶ ▶ ▶ Home ▶▶ Comfort ▶▶ Seat
- ▶▶ Heating Settings ▶▶ Panel Heating

When the seat heating is switched on, the armrests, the center panels of the doors and the center console can be heated.

- ▶ Tap on **Additional Surface Heating**. The **Panel Heating** will be linked to the seat heating.

Switching the seat ventilation on/off

Requirements:

- The power supply is switched on.

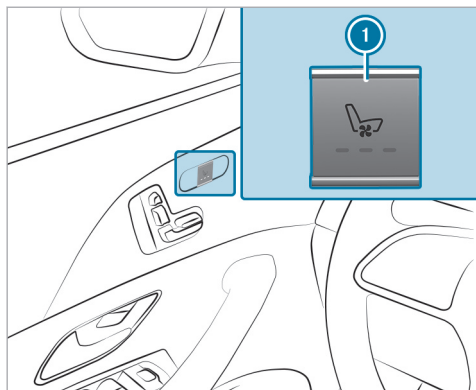

Seat ventilation in the cockpit

- ▶ Press button ① repeatedly until the desired ventilation level is set. Depending on the ventilation level, up to three indicator lamps will light up. If all indicator lamps are off, the seat ventilation is switched off.

Steering wheel

Adjusting the steering wheel manually

- ⚠ **WARNING** Risk of accident due to adjusting the vehicle settings while the vehicle is in motion

You could lose control of the vehicle in the following situations in particular:

- If you adjust the driver's seat, the head restraint, the steering wheel or the mirror while the vehicle is in motion
- If you fasten your seat belt while the vehicle is in motion

- ▶ Before starting the vehicle: in particular, adjust the driver's seat, head restraint, steering wheel and mirror, and fasten your seat belt.

- ⚠ **WARNING** Risk of entrapment for children when adjusting the steering wheel

Children could injure themselves if they adjust the steering wheel.

- ▶ Never leave children unattended in the vehicle.
- ▶ When leaving the vehicle, always take the key with you and lock the vehicle.

Unlocking

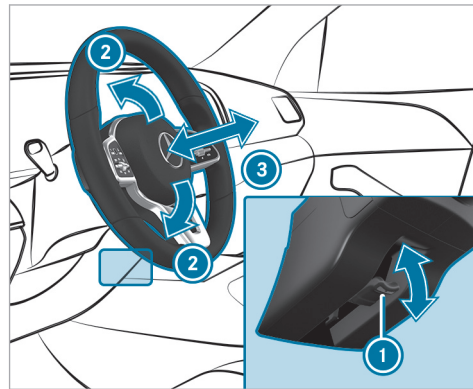

- ▶ Fold release lever ① down as far as it will go.

- ▶ Adjust height ② and distance ③ to the steering wheel.

Locking

- ▶ Fold release lever ① up as far as it will go.
- ▶ Check and make sure that the steering column is locked by moving the steering wheel.

Adjusting the steering wheel electrically

The steering wheel can be adjusted when the vehicle is switched off.

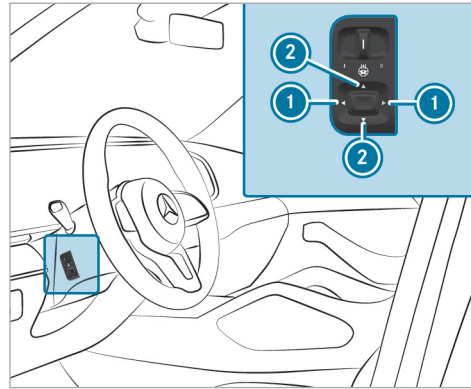

- ① To adjust the distance to the steering wheel
- ② To adjust the height
- ▶ Save the settings with the memory function (→ page 118).

Switching the steering wheel heater on/off

Depending on the vehicle version, the steering wheel heater can be switched on and off using a switch on the steering wheel.

Requirements

- The vehicle is switched on.

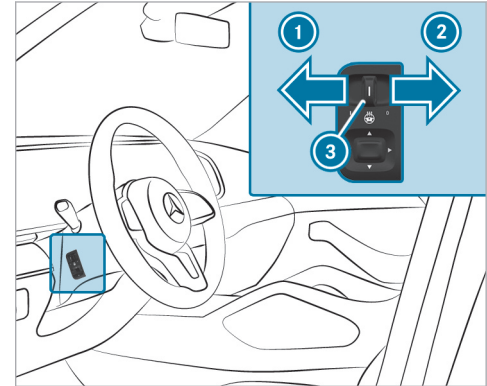

- ▶ **To switch on:** push the switch into position ①.
Indicator lamp ③ lights up.
- ▶ **To switch off:** push the switch into position ②.
Indicator lamp ③ will go out.

When you switch the ignition off, the steering wheel heater will switch off.

Decoupling the steering wheel heater from the seat heating

Requirements

- The power supply or the vehicle has been switched on.
- The steering wheel heater is linked to the seat heating.

Multimedia system:

- ▶ ▶ ▶  ▶ ▶ **Comfort** ▶ ▶ **Seat**
- ▶ ▶ **Heating Settings**

The function is active by default and the steering wheel heater is automatically activated and deac-

tivated when the seat heating is switched on and off.

- ▶ Tap on **Additional Steering Wheel Heating**.
The steering wheel heater will be decoupled from the seat heating.

Easy entry and exit feature

Using the easy entry and exit feature

⚠ WARNING Risk of accident when pulling away during the adjustment process of the easy entry and exit feature

You could lose control of the vehicle.

- ▶ Always wait until the adjustment process is complete before driving off.

⚠ WARNING Risk of becoming trapped when adjusting the easy entry and exit feature

You and other vehicle occupants, particularly children, may become trapped.

- ▶ Make sure that no one has any part of their body within the range of movement of the steering wheel and driver's seat.

If there is a risk of becoming trapped by the steering wheel:

- ▶ Move the steering wheel adjustment lever.
The adjustment process is stopped.

If there is a risk of becoming trapped by the driver's seat:

- ▶ Press the switch for seat adjustment.
The adjustment process is stopped.
- ▶ Never leave children unattended in the vehicle.
- ▶ When leaving the vehicle, always take the key with you and lock the vehicle.

Vehicles with memory function: You can stop the adjustment process by pressing one of the memory function position switches.

⚠ WARNING Risk of becoming trapped if children activate the easy entry and exit feature

Children could become trapped if they activate the easy entry and exit feature, particularly when unattended.

- ▶ Never leave children unattended in the vehicle.
- ▶ When leaving the vehicle, always take the key with you and lock the vehicle.

If the easy entry and exit feature is active, the steering wheel will move upwards and the driver's seat will move back in the following situations:

- You switch off the vehicle when the driver's door is open.
 - You open the driver's door when the vehicle is switched off.
- i** The steering wheel will then move upwards only if it is not already as high as it will go. The driver's seat will then move backwards only if it is not already at the rear of the seat adjustment range.

The driver's seat backrest will then move forwards only if it is not already in the frontmost position.

The steering wheel and the driver's seat will move back to the last driving position in the following cases:

- You switch the power supply or the vehicle on when the driver's door is closed.
- You close the driver's door when the vehicle is switched on.

The last drive position will be saved when:

- You switch off the vehicle.
- **Vehicles with memory function:** you call up the seat settings via the memory function.
- **Vehicles with memory function:** you save the seat settings via the memory function.

Vehicles with memory function: press one of the memory function position switches to stop the adjustment process.

Setting the easy entry and exit feature

Requirements

- The automatic seat adjustment has been activated (→ page 111).

Multimedia system:

→  **» Settings » Vehicle**
» Easy Entry And Exit Feature

▶ Select Steering Wheel & Seat, Steering Wheel Only or Off.

- i** If you are using an individual user profile, this information is used for the easy entry and exit feature. This will cause the driver's seat and steering wheel to move into the correct position automatically .

Memory function

Function of the memory function

⚠ WARNING Risk of an accident if the memory function is used while driving

If you use the memory function on the driver's side while driving, you could lose control of the vehicle as a result of the adjustments being made.

- ▶ Only use the memory function on the driver's side when the vehicle is stationary.

⚠ WARNING Risk of entrapment when adjusting the seat with the memory function

When the memory function adjusts the seat, you and other vehicle occupants – particularly children – could become trapped.

- ▶ During the adjustment process of the memory function, make sure that no one

has any body parts in the sweep of the seat.

- ▶ If someone becomes trapped, press a preset position button or seat adjustment switch immediately.

⚠ WARNING Danger of entrapment when memory function is activated by children

When children activate the memory function, they can get trapped, especially if they are unsupervised.

- ▶ Never leave children unattended in the vehicle.
- ▶ When leaving the vehicle, always take the key with you and lock the vehicle.

You can use the memory function when the ignition is switched off.

Seat adjustments for up to three people can be stored and called up using the memory function.

You can save settings for the following systems:

- Front seat
- Outside mirrors

- Head-up display
- Steering column
- Seat contour

Operating the memory function

Storing

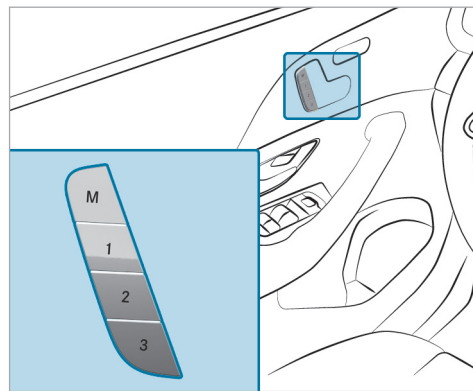

- ▶ Set the desired position for all systems.

- ▶ Press memory button **M** and then press preset position button **1**, **2** or **3** within three seconds. An acoustic signal sounds. The settings are stored.
- ▶ **To call up:** press or briefly hold preset position button **1**, **2** or **3**. After releasing the button, all systems are moved into the stored position.

Stowage areas

Notes on loading the vehicle

⚠ DANGER Risk of exhaust gas poisoning

Combustion engines emit poisonous exhaust gases such as carbon monoxide. Exhaust gases can enter the vehicle interior if the tailgate is open when the engine is running, especially if the vehicle is in motion.

- ▶ Always switch off the engine before opening the tailgate.
- ▶ Never drive with the tailgate open.

Objects in the deployment area of an air bag may prevent the air bag from functioning correctly. Observe the notes on protection provided by the air bag .

⚠ WARNING Risk of injury from unsecured items in the vehicle

If objects, luggage or loads are not secured or not secured sufficiently, they could slip, tip over or be thrown around and thereby hit vehicle occupants.

There is a risk of injury, particularly in the event of sudden braking or a sudden change in direction.

- ▶ Always stow objects in such a way that they cannot be thrown around.
- ▶ Before the journey, secure objects, luggage or loads against slipping or tipping over.

⚠ WARNING Risk of injury due to objects being stowed incorrectly

If objects in the vehicle interior are stowed incorrectly, they can slide or be thrown around and hit vehicle occupants. In addition, cup holders, open storage spaces and mobile phone receptacles cannot always retain all objects within.

There is a risk of injury, particularly in the event of sudden braking or abrupt changes in direction.

- ▶ Always store objects such that they cannot be thrown around in such situations.
- ▶ Always make sure that objects do not protrude from storage spaces, parcel nets or storage nets.
- ▶ Close the lockable storage spaces before starting a journey.
- ▶ Stow and secure objects that are heavy, hard, pointed, sharp-edged, fragile or too large in the cargo compartment.

⚠ WARNING Risk of accident from objects in the driver's footwell and front-passenger footwell

Objects in the driver's footwell and front-passenger footwell may impede pedal travel or block a depressed pedal.

This jeopardizes the operating and road safety of the vehicle.

- ▶ Stow all objects in the vehicle securely so that they cannot get into the driver's footwell or front-passenger footwell.
- ▶ Always install the floor mats securely and as prescribed in order to ensure that there is always sufficient clearance for the pedals.
- ▶ Do not use loose floor mats and do not lay multiple floor mats on top of one another.

Vehicles with automatic front-passenger air bag shutoff: objects trapped under the front-passenger seat may interfere with the function of the automatic front-passenger air bag shutoff or damage the system. Please observe the notes on

the function of the automatic front-passenger air bag shutoff (→ page 51).

⚠ WARNING - Risk of accident or injury when using the cup holder while the vehicle is moving

The cup holder cannot secure containers while the vehicle is moving.

If you use a cup holder while the vehicle is moving, the container may be flung around and liquids may be spilled. The vehicle occupants may come into contact with the liquid and if it is hot, they could be scalded. You could be distracted from traffic conditions and you may lose control of the vehicle.

- ▶ Only use the cup holder when the vehicle is stationary.
- ▶ Only use the cup holder for containers of the right size.
- ▶ Close the container, particularly if the liquid is hot.

! NOTE Damage to the cup holder

The cup holder can be damaged when folding back the rear armrest. When open, the cup holder can be damaged by body weight.

- ▶ The rear armrest can only be folded back when the cup holder is closed.
- ▶ Do not sit or support yourself on the cup holder when it is open.

! NOTE Damage to the rear armrest due to body weight

When folded out, the rear armrest can be damaged by body weight.

- ▶ Do not sit or support yourself on the rear seat armrest.

⚠ WARNING Risk of injury due to an open cargo compartment floor

If you drive with the cargo compartment floor open, objects could be flung around and hit vehicle occupants as a result. There is a risk

of injury, particularly in the event of sudden braking or a sudden change in direction.

- ▶ Always close the cargo compartment floor before a journey.

⚠ WARNING Risk of fire and injury from hot cigarette lighter

You can suffer burns if you touch the hot heating element or the hot socket of the cigarette lighter.

In addition, flammable materials can catch fire if:

- you drop the hot cigarette lighter.
- children e.g. hold the hot cigarette lighter to objects.

- ▶ Always hold the cigarette lighter by the knob.
- ▶ Always make sure that the cigarette lighter is out of the reach of children.
- ▶ Never leave children unattended in the vehicle.

⚠ WARNING Risk of burns from the tailpipe and tailpipe trims

The exhaust tailpipe and tailpipe trims can become very hot. If you come into contact with these parts of the vehicle, you could burn yourself.

- ▶ Always be particularly careful around the tailpipe and the tailpipe trims and supervise children especially closely in this area.
- ▶ Allow vehicle parts to cool down before touching them.

- ⓘ Leather is a natural product. It exhibits natural surface properties such as differences in structure, marks caused by growth and injury or subtle color differences. These surface properties are characteristics of leather and not material faults. Leather is also subject to a natural aging process during which the surface properties change.

The handling characteristics of your vehicle are dependent on the distribution of the load within the vehicle. You should bear the following in mind when loading the vehicle:

- Do not exceed the permissible total mass or the gross axle weight rating of the vehicle (including load and occupants). The values are specified on the vehicle identification plate on the vehicle's B-pillar.
- The load must not protrude above the upper edge of the seat backrests.
- Always use the partition net when transporting objects in the cargo compartment.
- Always place the load behind unoccupied seats if possible.
- Secure the load using the cargo tie-down rings and distribute the load evenly.

Notes on driving with a roof load

- Distribute the roof load and the load inside the vehicle evenly, placing heavy objects at the bottom. Also comply with the notes on loading the vehicle.

- Drive attentively, and avoid abrupt starts, braking and steering as well as rapid cornering.
 - When transporting roof loads and when the vehicle is fully loaded or fully occupied, select drive programs **E** and **C**. These are designed to focus on stability (→ page 190).
- i** For more information on stowage compartments and stowage areas, please refer to the Digital Operator's Manual.

Stowage spaces in the vehicle interior

Overview of the front stowage compartments

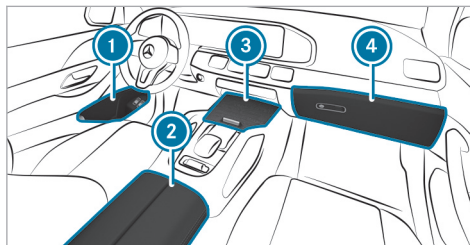

- 1 Stowage spaces in the doors
- 2 Stowage compartment in the armrest with USB ports (depending on vehicle equipment)
- 3 Stowage/telephone compartment with cup holder in the front center console
- 4 Glove box

Through-loading feature to the cargo compartment

Folding the rear seat backrest forwards

⚠ WARNING Risk of becoming trapped when adjusting the seats

When you adjust a seat, you may trap yourself or a vehicle occupant.

- ▶ When adjusting a seat, make sure that no one has any body parts in the sweep of the seat.

⚠ WARNING Risk of accident if the seat and seat backrest are not engaged

The seat and seat backrest can fold forwards. There is a risk of the following, in particular:

- The vehicle occupant may be pressed against the seat belt. The seat belt cannot protect as intended and could cause additional injury.

- A child restraint system will no longer be properly supported or positioned and will no longer fulfill its function as intended.
- The seat backrest will not be able restrain objects or goods in the cargo compartment.

Always ensure that the seat and seat backrest are engaged, in particular:

- Before persons travel in the vehicle while sitting on a seat with the easy entry and exit feature
- After the seat has been adjusted.
- After the easy entry and exit feature has been used
- After the cargo compartment enlargement has been folded forwards

Always ensure that all vehicle occupants have their seat belts fastened correctly and are sitting properly. Particular attention must be paid to children.

If you no longer require the folded-down rear seat backrest as a load area, fold the backrest back into place.

Make sure that the red marking of the lock verification indicator is no longer visible. Otherwise, the seat backrest is not locked.

Depending on the vehicle equipment, a message will be displayed on the instrument cluster instead of the red lock verification indicator.

Folding the rear seats forwards mechanically

Depending on the vehicle equipment, you can fold the outer seat backrests forwards mechanically.

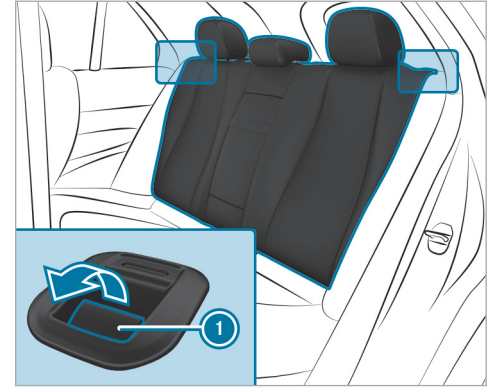

- ▶ Move the driver's or front passenger seat forwards, if necessary.
- ▶ **To fold the left and right seat backrests forwards:** if necessary, insert the head restraints for the seat backrests (→ page 110).
- ▶ Pull release lever ①.
- ▶ Fold the corresponding seat backrest forwards.

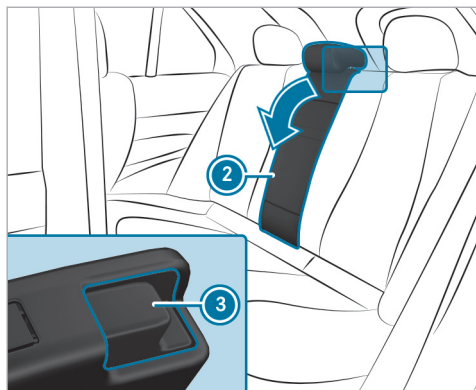

- ▶ Fold the rear seat armrest back if necessary.
- ▶ **To fold the center seat backrest forwards:** press release catch ③.
- ▶ Fold seat backrest ② forwards.

Observe the following recommendations:

- If you wish to fold only one of the outer seat backrests forwards, it is recommended that you fold the right seat backrest forwards.

- If you wish to fold one of the outer seat backrests forwards together with the center seat backrest, it is recommended that you fold the left and center seat backrests forwards.

Folding the rear seats forwards electrically

If a seat in the second row of seats is not engaged and locked, this will be shown on the multifunction display on the instrument cluster.

- ▶ Ensure that the center seat backrest is in an upright position.

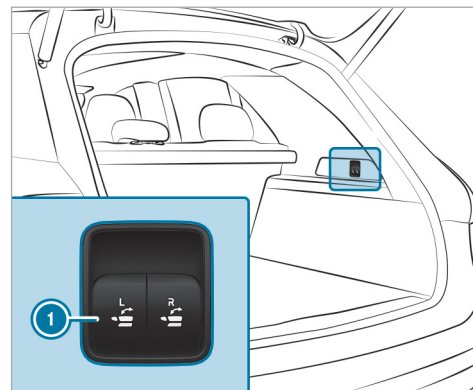

- ▶ **To fold the left or right seat backrest forwards:** briefly press one of buttons ①. The head restraint in the rear passenger compartment will move into a suitable position. The rear seat will fold forwards. The center seat backrest will fold forwards together with the left seat backrest.

Observe the following recommendations:

- If you wish to fold only one of the outer seat backrests forwards, it is recommended that you fold the right seat backrest forwards.
- If you wish to fold one of the outer seat backrests forwards together with the center seat backrest, it is recommended that you fold the left and center seat backrests forwards.

Folding the rear seat backrest back

1 **NOTE** Damage caused by trapping the seat belt when folding back the seat backrest

The seat belt could become trapped and thus damaged when the seat backrest is folded back.

- ▶ Make sure that the seat belt is not trapped when folding back the seat backrest.

Folding back the rear seat mechanically

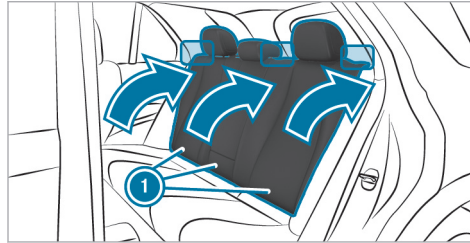

- ▶ Move the driver's or front passenger seat forwards, if necessary.
- ▶ Swivel seat backrest ① back until it engages.
- ▶ Make sure that the red marking of the lock verification indicator is no longer visible. Otherwise, the seat backrest is not locked.

Folding back the rear seat electrically

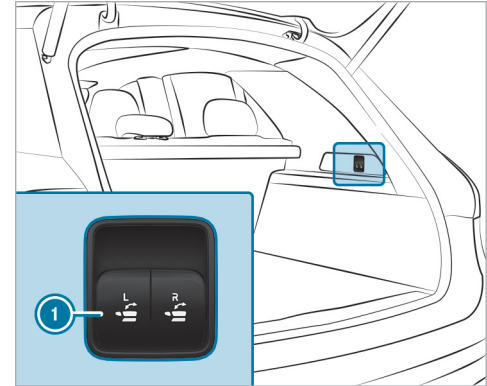

- ▶ **Left or right seat backrest:** briefly pull one of buttons ①. The rear seat will fold back. The center seat backrest will fold back together with the left-hand seat backrest.
If a seat backrest is not engaged and locked, this will be shown on the multifunction display on the instrument cluster.

Folding the seat backrest on the third row of seats forwards

Requirements:

- The seats and the seat backrests on the second row of seats have been moved forwards sufficiently.

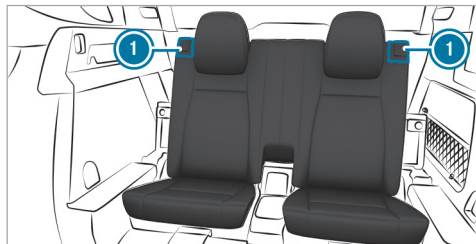

- ▶ Pull release catch ① for the seat backrest forwards.
- ▶ Fold the seat backrest forwards.

Folding back the seat backrest on the third row of seats

Requirements:

- The seats and the seat backrests on the second row of seats have been moved forwards sufficiently.

- ▶ Swing the seat backrest back until it audibly engages.

EASY-PACK cargo compartment cover and partitioning net cassette

Notes on the cargo compartment cover

⚠ WARNING Risk of injury or death due to poorly secured objects

The cargo compartment cover alone cannot secure or restrain heavy objects, items of luggage or heavy loads.

You could be hit by an unsecured load, particularly in the event of abrupt changes in direction, sudden braking or an accident.

- ▶ Always stow objects in such a way that they cannot be thrown around.
- ▶ Secure objects, luggage or loads against slipping or tipping over, e.g. by using tie downs, even if you are using the cargo compartment cover.

! **NOTE** Damage to the cargo compartment cover when loading the vehicle

The cargo compartment cover may be damaged when the vehicle is being loaded.

- ▶ Do not place any objects above the lower edge of the side windows or on the cargo compartment cover.

Extending/retracting the cargo compartment cover

Extending

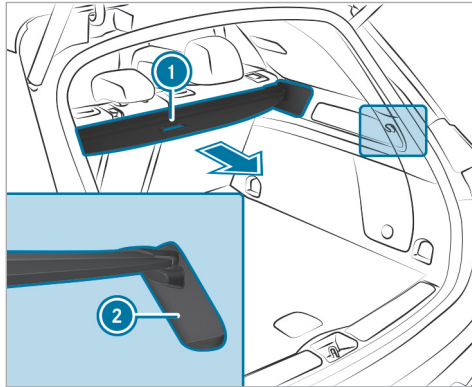

- ▶ Pull the cargo compartment cover back by grab handle ① and hook it into brackets ② on the left and right.

Retracting

- ▶ Remove the cargo compartment cover from the brackets on the left and right.
- ▶ Guide the cargo compartment cover forwards using grab handle ① until it is fully retracted.

The rolled-up cargo compartment cover can be used in two positions:

- Folded 45° upwards for loading (fold down before commencing your journey)
- Horizontal position

Installing/removing the cargo compartment cover

Requirements

- The cargo compartment cover is rolled up.

Removing the cargo compartment cover

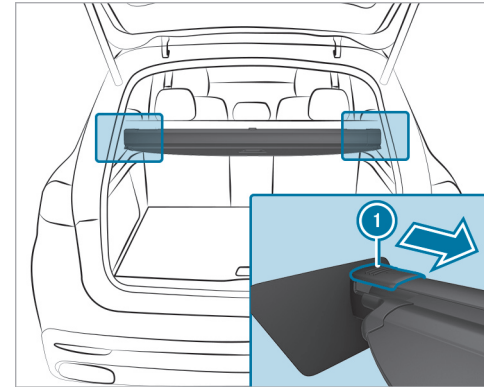

- ▶ Press end cap ① on the left or right inwards.
- ▶ Pull out the cargo compartment cover backwards.

Stowing the cargo compartment cover

Depending on the vehicle variant, the cargo compartment cover can be stowed under the cargo floor.

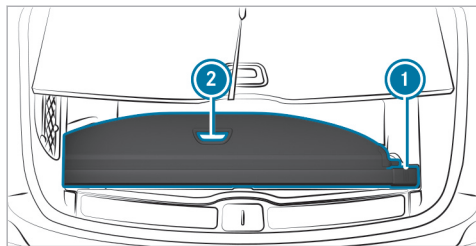

- ▶ Open the cargo floor .
- ▶ **To insert:** place the cargo compartment cover in brackets ①, first on the left and then the right. Comply with the instructions on the vehicle to ensure it is seated correctly.
- ▶ **To remove:** push the cargo compartment cover slightly to the left using grab handle ②.
- ▶ Remove the cargo compartment cover from brackets ①, first on the right and then on the left.

Installing the cargo compartment cover

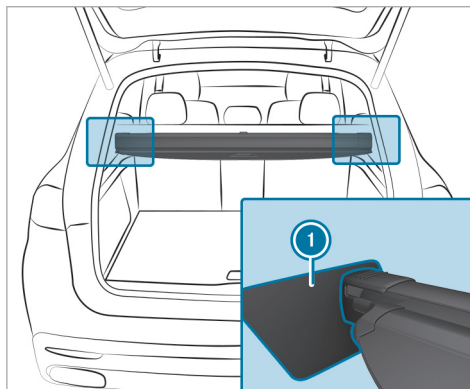

- ▶ Insert the cargo compartment cover in brackets ① on the left and right. The end caps of the cargo compartment cover will engage audibly.

Installing/removing the partitioning net cassette

Requirements:

- The partitioning net has been rolled up.

Removing

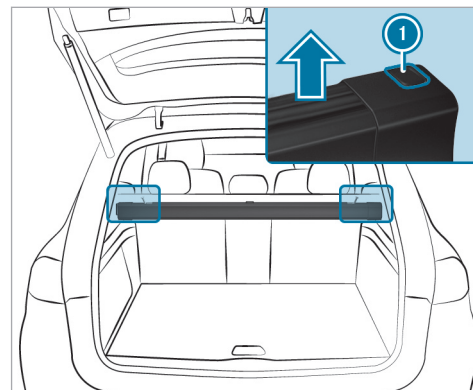

- ▶ Press button ① on the left or right.

- ▶ Remove the partitioning net cassette by lifting it upwards.

Installing

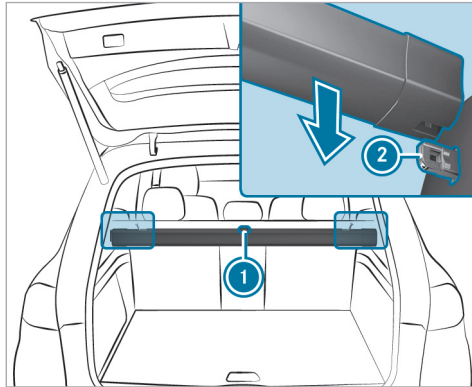

- ▶ With tab ① facing backwards, push the partitioning net cassette into brackets ②. The partitioning net cassette will engage.

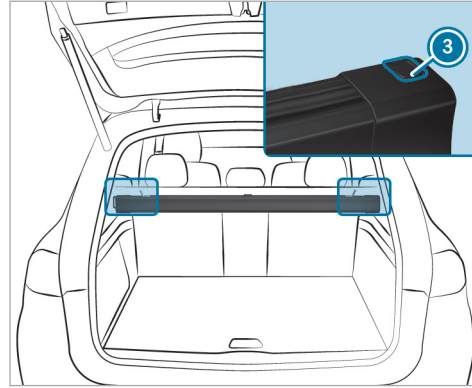

- ▶ Ensure that red lock verification indicators ③ on the left and right are no longer visible. Otherwise, the partitioning net cassette will not be locked.

Attaching the partitioning net

- ⚠ **WARNING** Risk of injury or death due to poorly secured objects

The partitioning net alone cannot secure or restrain heavy objects, items of luggage or heavy loads.

You could be hit by an unsecured load, particularly in the event of abrupt changes in direction, sudden braking or an accident.

- ▶ Always stow objects in such a way that they cannot be thrown around.
- ▶ Secure objects, luggage or loads against slipping or tipping over, e.g. by using tie downs, even if you are using the partitioning net.

For safety reasons, always use a partitioning net when transporting a load.

Damaged partitioning nets can no longer fulfil their protective functions and must be replaced. Visit a qualified specialist workshop.

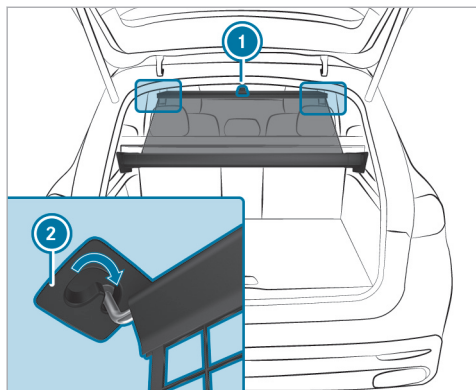

- ▶ Guide the partition net upwards using tab ❶.
- ▶ Hook the partition net into holders ❷ on the left and right.

Overview of the tie-down eyes in the cargo compartment

Observe the notes on loading the vehicle (→ page 119).

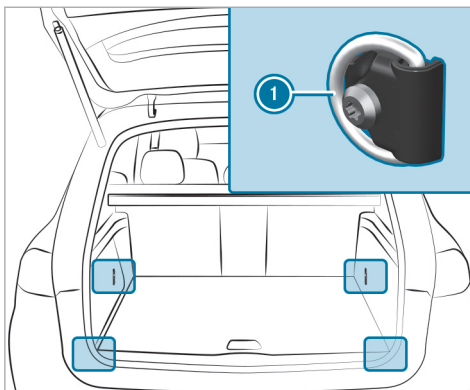

- ❶ Tie-down eyes

Overview of bag hooks

⚠ WARNING Risk of injury when using bag hooks with heavy objects

The bag hooks cannot restrain heavy objects or items of luggage.

Objects or items of luggage may be flung around and hit vehicle occupants.

- ▶ Only hang light objects on the bag hooks.
- ▶ Never hang hard, sharp-edged or fragile objects on the bag hooks.

Observe the notes on loading the vehicle (→ page 119).

Subject the bag hooks to a maximum load of 6.6 lbs (3 kg) and do not attach any goods to them.

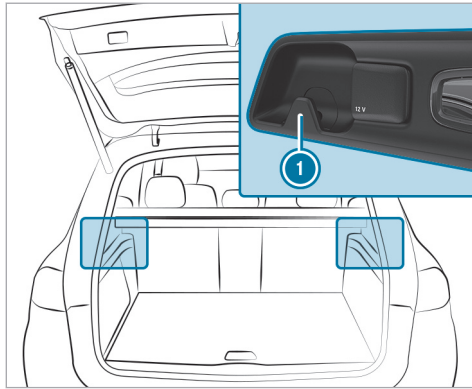

① Bag hooks

Coat hook on the tailgate

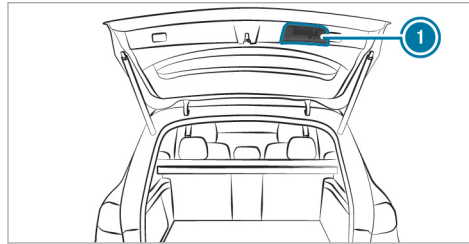

① Coat hook on the tailgate

Coat hooks are not suitable for heavy objects. Use the coat hooks only for light objects such as jackets.

EASY-PACK load-securing kit

■ Notes on the snap-in module for the cargo compartment (telescopic rods)

The EASY-PACK load-securing kit allows you to use your cargo compartment for a variety of purposes. The components are located in the stowage space under the cargo floor.

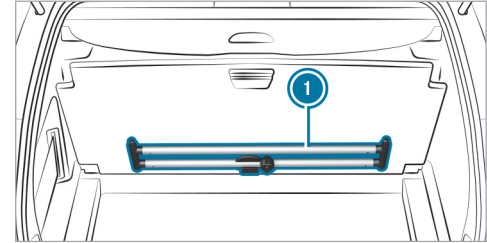

① Telescopic rod with mounting elements and holders

■ Installing a telescopic rod

⚠ WARNING Risk of injury due to an open cargo compartment floor

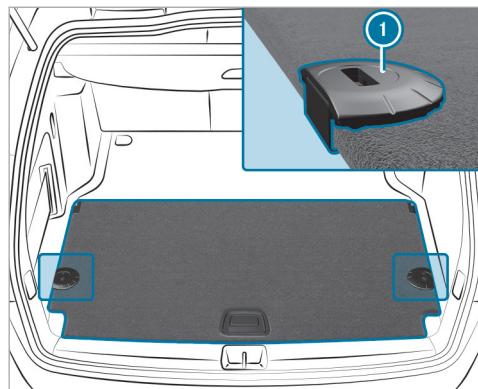

If you drive with the cargo compartment floor open, objects could be flung around and hit vehicle occupants as a result. There is a risk of injury, particularly in the event of sudden braking or a sudden change in direction.

▶ Always close the cargo compartment floor before a journey.

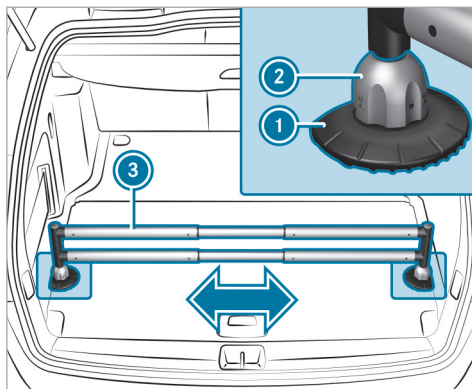

- ▶ Open the cargo floor .
- ▶ Attach holders ① in the desired position to the side of the cargo floor.
- ▶ Close the cargo floor.



- ▶ Turn the mounting elements ② to .
- ▶ Insert the mounting elements ② into the holders ①.
- ▶ Extend the telescopic rod ③.
- ▶ Insert the telescopic rod ③ into the mounting elements ②.
- ▶ Turn both mounting elements ② to  until you feel them engage.

Locking and unlocking the cargo compartment floor

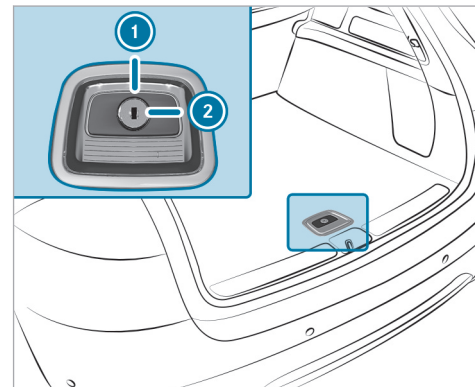

- ▶ Turn the emergency key a quarter turn clockwise ② (to lock) or counter-clockwise ① (to unlock).

Attaching a roof luggage rack

⚠ WARNING Risk of accident due to exceeding the maximum roof load

The vehicle center of gravity and the usual driving characteristics as well as the steering and braking characteristics alter.

If you exceed the maximum roof load, the driving characteristics, as well as steering and braking, will be greatly impaired.

- ▶ Never exceed the maximum roof load and adjust your driving style.

You will find information on the maximum roof load in the "Technical data" section.

⚠ NOTE Damage to the vehicle due to not observing the maximum permitted headroom clearance

If the vehicle height is greater than the maximum permitted headroom clearance, the roof and other parts of the vehicle may be damaged.

- ▶ Observe the signposted headroom clearance.
- ▶ If the vehicle height is greater than the permitted headroom clearance, do not enter.
- ▶ Observe the changed vehicle height with add-on roof equipment.

⚠ NOTE Vehicle damage from non-approved roof luggage racks

The vehicle could be damaged by roof luggage racks that have not been tested and approved for Mercedes-Benz.

- ▶ Use only roof luggage racks tested and approved for Mercedes-Benz.
- ▶ Depending on the vehicle equipment, ensure that the sliding sunroof can be fully raised when the roof luggage rack is installed.
- ▶ Depending on the vehicle equipment, ensure that the tailgate can be fully

opened when the roof luggage rack is installed.

- ▶ Position the load on the roof luggage rack in such a way that the vehicle will not sustain damage even when it is in motion.

⚠ NOTE Damage to the panorama roof with power tilt/sliding panel due to non-approved roof luggage racks

The panorama roof with power tilt/sliding panel may be damaged by the roof luggage rack if you attempt to open it when using a roof luggage rack not tested and approved for Mercedes-Benz.

- ▶ When a roof luggage rack is installed, open the panorama roof with power tilt/sliding panel only if this has been tested and approved for Mercedes-Benz.

The panorama roof with power tilt/sliding panel may be raised to allow ventilation of the vehicle interior.

- ▶ Secure the roof rack to the roof railing.
- ▶ Observe the manufacturer's installation instructions.

Cup holder

Switching the cooling or heating function for the temperature-controlled cup holder on or off

⚠ WARNING Risk of injury by touching the heating elements

The cup holder's heating elements may be very hot.

You can burn yourself on them.

- ▶ Do not touch the cup holder's hot heating elements.
- ▶ Ensure that no children can access the cup holder's hot heating elements.
- ▶ Never leave children unattended in the vehicle.

! **NOTE** Damage to objects in the temperature-controlled cup holder

If you place objects into the temperature-controlled cup holder, they may become damaged.

- ▶ Do not place objects into the temperature-controlled cup holder.

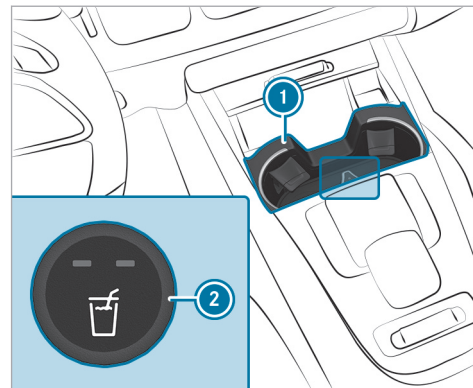

Cup holder in the front center console

- ▶ **To switch on:** on cup holder ①, press button ② repeatedly until the blue (keep cool) or red (keep warm) indicator lamp on the button lights up.

If you use the heating function, the metal insert of the cup holder will be heated. Once a certain temperature has been reached, the warning lamp will light up. Do not reach into

the cup holder's metal insert when the warning lamp is lit.

- ▶ **To switch off:** press button ② repeatedly until the indicator lamp on the button goes out.
- ① Clean the removable rubber mat only with clean, lukewarm water and the cup holder only with a soft cloth.

Ashtray and cigarette lighter

Using the ashtray

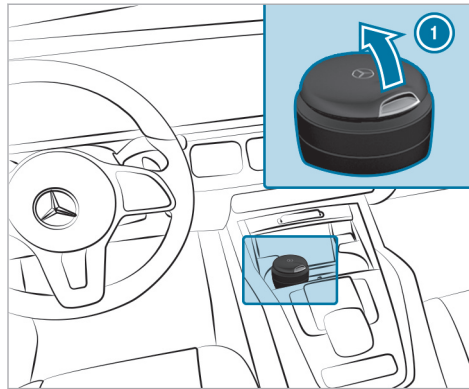

- ▶ Place the ashtray in one of the cup holders in the center console or in the rear passenger compartment.
- ▶ Check that it is seated firmly.
- ▶ Comply with the notes on loading the vehicle (→ page 119).

- ▶ **To open the ashtray:** fold lid ① upwards.

- ① You can remove the top part of the ashtray for cleaning or emptying by twisting it. Clean the ashtray, e.g. with clean, lukewarm water.

Sockets

Using the 12 V socket

Requirements:

- Only connect devices up to a maximum of 240 W (20 A).

Depending on the vehicle equipment, the vehicle has the following 12 V sockets:

- In the stowage compartment in the front center console
- In the cargo compartment

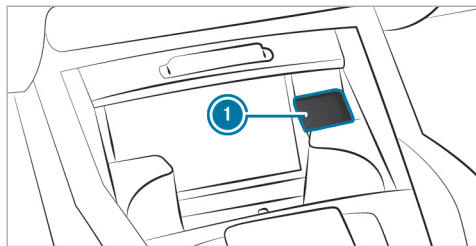

Example: 12 V socket in the stowage compartment in the front center console

- ▶ Lift up cap ① of the socket and insert the plug of the device.

If you have connected a device to the 12 V socket, leave the cover of the stowage compartment open.

Using the 115 V socket in the rear passenger compartment

- ⚠ **DANGER** Risk of fatal injuries due to a damaged connecting cable or a damaged socket

You could receive an electric shock if the connecting cable or the 115 V power socket is pulled out of the trim or is damaged or wet.

- ▶ Use only connecting cables that are dry and free of damage.
- ▶ When the vehicle is switched off, make sure that the 115 V power socket is dry.
- ▶ Immediately have the 115 V power socket checked or replaced at a qualified specialized workshop if it is damaged or has been pulled out of the trim.
- ▶ Never plug the connecting cable into a 115 V power socket that is damaged or has been pulled out of the trim.

- ⚠ **DANGER** Risk of death due to using the socket incorrectly

In particular, you could receive an electric shock:

- If you touch the inside of the socket
- If you insert unsuitable devices or objects into the socket
- ▶ Do not touch the inside of the socket.
- ▶ Only connect suitable devices to the socket.

Requirements:

- Only connect devices with a suitable plug which conforms to the standards specific to the country you are in.
- Only connect devices up to a maximum of 150 W (1.3 A).
- Do not use multiple socket outlets.

Depending on the vehicle equipment, the design of the center console and stowage compartment may differ.

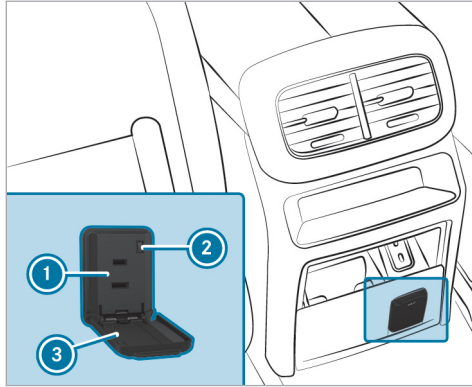

- ▶ Mercedes-Maybach vehicles with individual rear seats: open the stowage compartment of the center console of the rear passenger compartment .
- ▶ Open flap ③ .
- ▶ Insert the plug of the device into 115 V socket ① .
When the on-board electrical system voltage is sufficient, indicator lamp ② lights up.

Overview of USB ports

Depending on the vehicle equipment, the vehicle has the following USB ports:

- in the stowage compartment of the cockpit armrest (→ page 122)
- in the front center console next to the mobile phone stowage compartment
- In the folding compartment in the center console of the rear passenger compartment
- vehicles with three rows of seats: between the seats of the third row of seats

If the vehicle is switched on you can charge USB devices, e.g. mobile phones, at USB ports. Depending on the vehicle equipment, the charging power is up to 100 W.

Wireless charging of the mobile phone and connection with the exterior antenna

Notes on wirelessly charging a mobile phone

⚠ WARNING Risk of injury due to objects being stowed incorrectly

If objects in the vehicle interior are stowed incorrectly, they can slide or be thrown around and hit vehicle occupants. In addition, cup holders, open stowage spaces and mobile phone receptacles cannot always retain all objects within.

There is a risk of injury, particularly in the event of sudden braking or a sudden change in direction.

- ▶ Always stow objects so that they cannot be thrown around in such situations.
- ▶ Always make sure that objects do not protrude from stowage spaces, parcel nets or stowage nets.
- ▶ Close the lockable stowage spaces before starting a journey.

- ▶ Always stow and secure heavy, hard, pointed, sharp-edged, fragile or bulky objects in the trunk/cargo compartment.

Observe the notes on loading the vehicle.

⚠ WARNING Risk of fire from placing objects in the mobile phone storage compartment

Placing other objects in the mobile phone storage compartment could constitute a fire hazard.

- ▶ Apart from a mobile phone, do not place any other objects in the mobile phone storage compartment, especially those made of metal.

! NOTE Damage to objects caused by placing them in the mobile phone storage compartment

If objects are placed in the mobile phone storage compartment, these may be damaged by electromagnetic fields.

- ▶ Do not place credit cards, storage media, ski passes or other objects sensitive to electromagnetic fields in the mobile phone storage compartment.

! NOTE Damage to the mobile phone storage compartment caused by liquids

If liquids enter the mobile phone storage compartment, the compartment may be damaged.

- ▶ Ensure that no liquids enter the mobile phone storage compartment.

Always observe the notes for persons with electronic medical aids (→ page 36).

- Depending on the vehicle equipment, the mobile phone is connected to the vehicle's exterior antenna via the charging module.
- The charging function and wireless connection of the mobile phone to the vehicle's exterior antenna are available only if the vehicle is switched on.

- Small mobile phones may not be able to be charged in every position of the mobile phone stowage compartment.
- Large mobile phones that do not rest flat in the mobile phone stowage compartment may not be able to be charged or connected with the vehicle's exterior antenna.
- The mobile phone may heat up during the charging process. This may also depend on the applications (apps) currently open in the background.
- To ensure more efficient charging and connection with the vehicle's exterior antenna, remove the protective cover from the mobile phone. Protective covers that are necessary for wireless charging are an exception.

Wireless charging of a mobile phone in the cockpit

Requirements:

- The mobile phone is suitable for wireless charging.

- ❶ A list of compatible mobile phones can be found at: <https://www.mercedes-benz-mobile.com/>

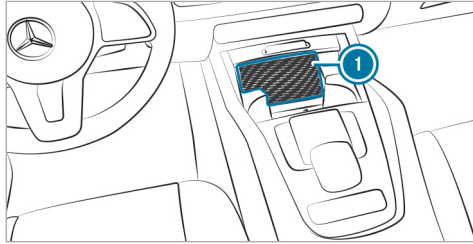

- ▶ Place the mobile phone as close to the center of mat ❶ as possible with the display facing upwards. When a message is shown in the multimedia system, the mobile phone is being charged. Malfunctions detected during the charging process are shown in the multimedia system display.
- ❶ The mat can be removed for cleaning, e.g. using clean, lukewarm water.

Installing/removing the floor mats

- ⚠ **WARNING** Risk of accident due to objects in the driver's footwell

Objects in the driver's footwell may impede pedal travel or block a depressed pedal. This jeopardizes the operating and road safety of the vehicle.

- ▶ Stow all objects in the vehicle securely so that they cannot get into the driver's footwell.
- ▶ Always install the floor mats securely and as prescribed in order to ensure that there is always sufficient room for the pedals.
- ▶ Do not use loose floor mats and do not place floor mats on top of one another.

Installing floor mats

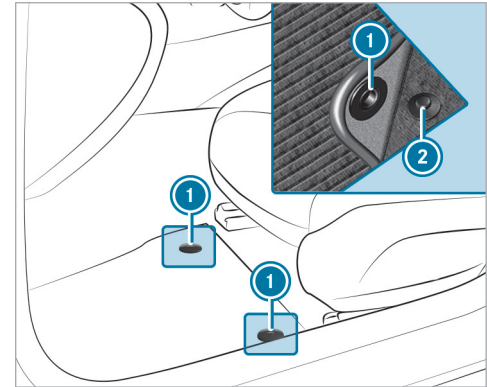

- ▶ Move the corresponding seat backwards and lay the floor mat in the footwell.
- ▶ Press studs ❶ onto holders ❷.
- ▶ Adjust the corresponding seat.

- ① **Vehicles with a third row of seats:** To install the floor mats on the third row of seats, slide the corresponding seat on the second row of seats forwards.

Removing floor mats

- ▶ Pull the floor mat off holders ②.
- ▶ Remove the floor mat.

- ① **Vehicles with a third row of seats:** To remove the floor mats on the third row of seats, slide the corresponding seat on the second row of seats forwards.

Exterior lighting

Information about lighting systems and your responsibility

The various lighting systems of the vehicle are only aids. The driver of the vehicle is responsible for correct vehicle illumination in accordance with the prevailing light and visibility conditions, legal requirements and traffic situation.

Light switch

Operating the light switch

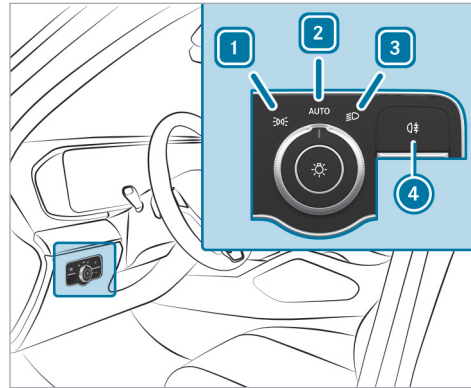

- 1 Parking lamp and license plate lamp
- 2 **AUTO** Automatic driving lights (preferred light switch position)
- 3 Low beam / high beam
- 4 Switches the rear fog light on/off.

When low beam is activated, the indicator lamp for the parking lamp will be deactivated and replaced by the low-beam indicator lamp.

▶ Always park your vehicle safely using sufficient lighting, in accordance with the relevant legal stipulations.

! **NOTE** Battery discharging by operating the parking lamps

Do not have the parking lamps switched on over a period of several hours.

If the battery is heavily discharged, the parking lamp will be switched off automatically to facilitate the next vehicle start.

The exterior lighting (except parking lamp) will switch off automatically when the driver's door is opened.

- Observe the notes on locator lighting (→ page 146).

Switching on accident scene lighting

▶ Switch off the vehicle.

- ▶ Switch on the hazard warning lights (→ page 143).
- ▶ Turn the light switch from the **AUTO** position to the  position.
The low beam will be switched on despite the vehicle being switched off.

The accident scene lighting will be switched off if:

- you switch off the hazard warning lights.
- you turn the light switch back to **AUTO**.
- the battery is insufficiently charged.

Automatic driving lights function

When the vehicle is switched on, the side lamps, low beam and daytime running lights will be switched on automatically depending on the ambient light.

⚠ WARNING Risk of accident when the low beam is switched off in poor visibility

When the light switch is set to **AUTO**, the low beam may not be switched on automatically if there is fog, snow or other causes of poor visibility such as spray.

- ▶ In such cases, turn the light switch to .

The automatic driving lights are only an aid. You are responsible for the vehicle lighting.

Switching the rear fog light on/off

Requirements

- The light switch is in the  or **AUTO** position.

- ▶ Press button .

Please observe the country-specific laws on the use of rear fog lamps.

- ⓘ Vehicles with AIRMATIC or E-ACTIVE BODY CONTROL with off-road package: when the rear fog light is switched on, off-road level +3 will not be available. If the rear fog light is switched on and off-road level +3 is activated, the vehicle will be lowered to off-road level +2.

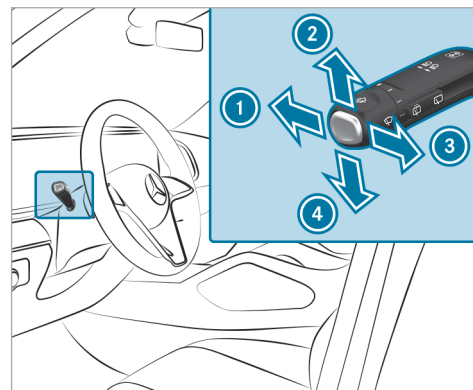

Operating the combination switch for the lights



- ① High beam
- ② Turn signal light, right
- ③ Headlamp flashing
- ④ Turn signal light, left

- ▶ Use the combination switch to select the desired function.

Switching on high beam

- ▶ Turn the light switch to the  or **AUTO** position.
- ▶ Push the combination switch in the direction of arrow ①.
When high beam is activated, the indicator lamp for low beam  will be deactivated and replaced by the indicator lamp for high beam .

Switching off high beam

- ▶ Push the combination switch in the direction of arrow ① or pull it in the direction of arrow ③.

Headlamp flashing

- ▶ Pull the combination switch in the direction of arrow ③.

Turn signals

- ▶ **To indicate briefly:** push the combination switch briefly to the point of resistance in the direction of arrow ② or ④.
The corresponding turn signal light will flash three times.

▶ **To indicate permanently:** push the combination switch beyond the point of resistance in the direction of arrow ② or ④.

Vehicles with Active Lane Change Assist:

- A turn signal indicator activated by the driver may continue to operate for the duration of the lane change.
- If the driver indicated directly beforehand but a lane change was not immediately possible, the turn signal indicator may activate automatically.

Activating/deactivating the hazard warning lights

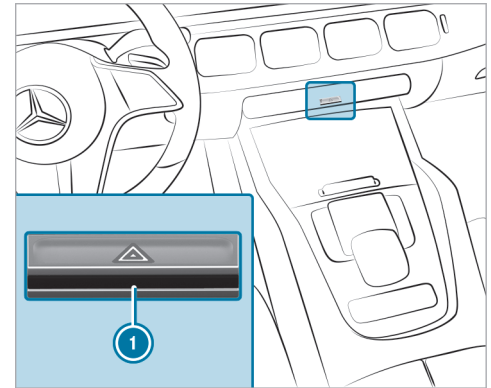

- ▶ Press button ①.

The hazard warning lights will switch on automatically if:

- the air bag has been deployed.

When the turn signal indicator is activated, the hazard warning lights will be interrupted.

Active headlamps

Active headlamps function

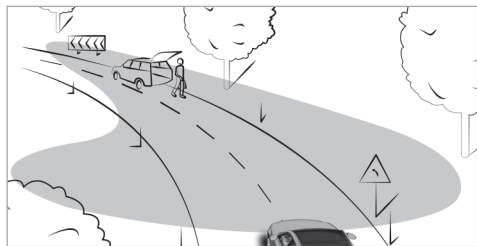

- The headlamps follow the steering movements.
- Relevant areas are better illuminated during a journey.

The functions will be active when low beam is switched on.

Depending on the vehicle's equipment, the course of the lane in which you are driving will also be evaluated and the active headlamps function will adjust the light in advance.

Adaptive Highbeam Assist

Adaptive Highbeam Assist function

⚠ WARNING Risk of accident despite Adaptive Highbeam Assist

Adaptive Highbeam Assist does not react to:

- Road users without lights, e.g. pedestrians
- Road users with poor lighting, e.g. cyclists
- Road users whose lighting is obstructed, e.g. by a barrier

On very rare occasions, Adaptive Highbeam Assist may fail to recognize other road users with their own lighting, or may recognize them too late.

In these, or in similar situations, the automatic high beam will not be deactivated or will be activated despite the presence of other road users.

- ▶ Always observe the road and traffic conditions carefully and switch off the high beam in good time.

System limits

Adaptive Highbeam Assist cannot take into account road, weather or traffic conditions.

Detection may be restricted in the following cases:

- In poor visibility, e.g. fog, heavy rain or snow
- If there is dirt on the sensors or the sensors are obscured

Adaptive Highbeam Assist is only an aid. You are responsible for adjusting the vehicle's lighting to the prevailing light, visibility and traffic conditions.

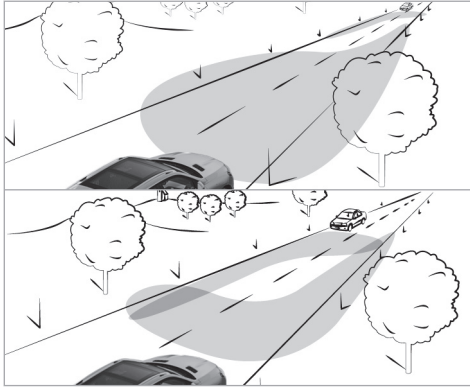

Adaptive Highbeam Assist automatically switches between the following types of light:

- Low-beam headlamps
- High beam

At speeds greater than 19 mph (30 km/h):

- If no other road users are detected, high beam will switch on automatically.

The high beam will switch off automatically in the following cases:

- At speeds below 16 mph (25 km/h)
- If other road users are detected
- If street lighting is sufficient

At speeds greater than approximately 31 mph (50 km/h):

- The headlamp range of the low beam will be regulated automatically based on the distance to other road users.
- i** The system's optical sensor is located behind the windshield near the overhead control panel.

Switching Adaptive Highbeam Assist on/off

Switching on

- ▶ Turn the light switch to the **AUTO** position.
 - ▶ Switch on high beam using the combination switch.
- If Adaptive Highbeam Assist is activated, the  indicator lamp will light up on the driver's display.

Switching off

- ▶ Switch off high beam using the combination switch.

Switching the daytime running lamps on/off

Multimedia system:

 **▶ Settings ▶ Light**
▶ Intelligent Light System

- ▶ Activate or deactivate the **Daytime Running Lights**.
- i** The availability of the function is dependent on the country.

Setting the exterior lighting switch-off delay time

Multimedia system:

-  » Settings » Light
- ▶ Interior/Exterior Lighting
- ▶ External Lighting Delay

- ▶ Set the switch-off delay time.
When the vehicle's engine is switched off, the exterior lighting will be activated for the set time.

Activating/deactivating the locator lighting

Multimedia system:

-  » Settings » Light
- ▶ Interior/Exterior Lighting

- ▶ Activate or deactivate **Locator Lighting**.





When the function is activated, the exterior lighting will light up for 40 seconds after the vehicle is unlocked or the driver's door is opened when the vehicle is parked and not locked. When you start the vehicle, the locator lighting will be deactivated and the automatic driving lights activated.

Interior lighting

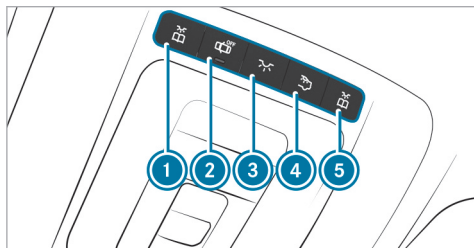
Adjusting the interior lighting

Front overhead control panel



- ①  Front right reading lamp
- ②  Front left reading lamp
- ③  Automatic interior lighting control
- ④  Rear interior lighting
- ⑤  Front right reading lamp

- ▶ **To switch on or off:** press button ① - ⑤ accordingly.

Control panel in the grab handle

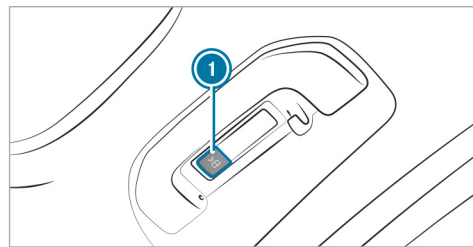

- ①  Rear reading lamp

- ▶ **To switch on or off:** press the ① button.

Adjusting the ambient lighting

Multimedia system:

-  » Comfort » Ambient Light

Setting the color

- ▶ Select **Color**.
- ▶ Select **Monochrome** or **Multi-color**.
- ▶ Set the desired color or color scheme.

Adjusting the brightness

- ▶ Select **Brightness**.
- ▶ Adjust the brightness.
- ⓘ Depending on the ambient light, the ambient lighting will automatically switch between day and night modes.

Activating effects

- ▶ Select **Effects**.
- ▶ Activate the desired effect.
- ⓘ Depending on the vehicle equipment, different effects are available.

Multi-color Animation

- The chosen color combination will change at predefined intervals.

Climate

- If changes are made to the temperature setting in the vehicle, the color of the ambient lighting will change briefly.

Greeting

- When you get into the vehicle, a special color animation will play.

Switching the interior lighting switch-off delay time on/off

Multimedia system:

-  ▶ Settings ▶ Light
- ▶ Interior/Exterior Lighting
- ▶ Interior Lighting Delay



- ▶ Activate or deactivate **Interior Lighting Delay**. If this function is active, the interior lighting will be switched on for a short time after the end of the journey.

Windshield wiper and windshield washer system

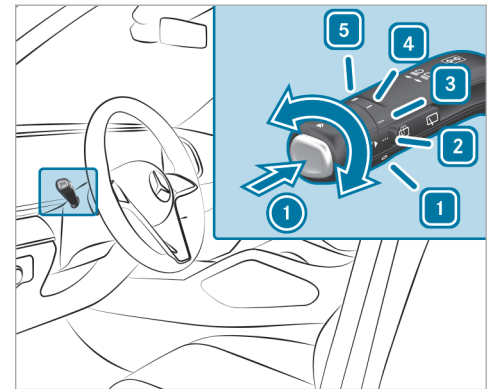
Switching the windshield wipers on/off





- | | | |
|----------|----------|----------------------------|
| 1 | 0 | Windshield wipers off |
| 2 | ... | Automatic wiping, normal |
| 3 | | Automatic wiping, frequent |
| 4 | — | Continuous wiping, slow |
| 5 | == | Continuous wiping, fast |

- ▶ Turn the combination switch to the corresponding position **1** - **5**.
- ▶ **Single wipe/washing:** push the button on the combination switch in the direction of arrow **1**.
 -  Single wipe
 -  Wipes with washer fluid
- i** Observe the notes on washing the vehicle in a car wash (→ page 378).

Vehicles with MAGIC VISION CONTROL: in position **2** or **3**, the windshield washing process is automatically triggered if dirt is detected on the windshield unless the **Add Washer Fluid** message is being displayed.

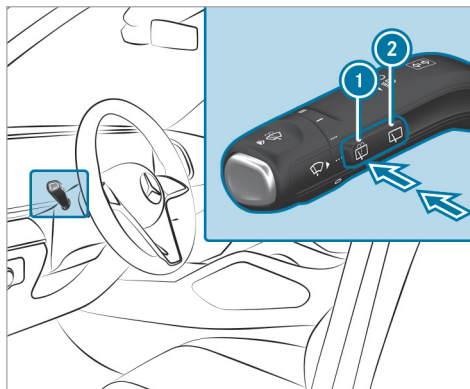
Switching the rear window wiper on/off



- 1**  Single wipe/washing
- 2**  Intermittent wiping

- ▶ **Single wipe:** press button **1** as far as the point of resistance.
- ▶ **Wiping with washer fluid:** press button **1** beyond the point of resistance.

- ▶ **Switching intermittent wiping on/off:** press button **2**.
- Vehicles with rain sensor:** The wipe interval will automatically adapt to the driving conditions. The  symbol will appear on the driver's display when the rear window wiper is switched on.

Changing the windshield wiper blades

⚠ WARNING Risk of becoming trapped if the windshield wipers are switched on while wiper blades are being replaced

If the windshield wipers begin to move while you are changing the wiper blades, you can be trapped by the wiper arm.

- ▶ Always switch off the windshield wipers and vehicle before changing the wiper blades.

Moving the wiper arms into the replacement position

- ▶ Switch the vehicle on and then off again immediately.
- ▶ Within around 15 seconds, press and hold the  button on the combination switch for approximately three seconds (→ page 147). The wiper arms will move into the replacement position.

Removing the wiper blades

- ▶ Fold the wiper arms away from the windshield.

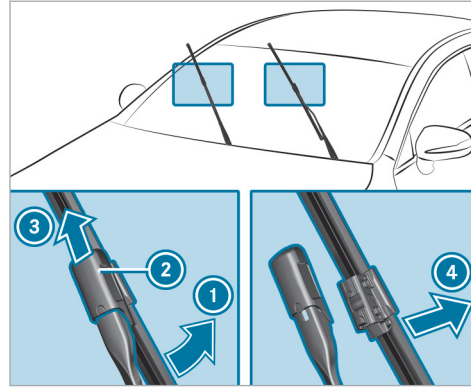

- ▶ Hold the wiper arm with one hand. With the other hand, turn the wiper blade away from the wiper arm in the direction of arrow ① as far as it will go.
- ▶ Slide catch ② in the direction of arrow ③ until it engages in the removal position.
- ▶ Remove the wiper blade from the wiper arm in the direction of arrow ④.

Installing the wiper blades

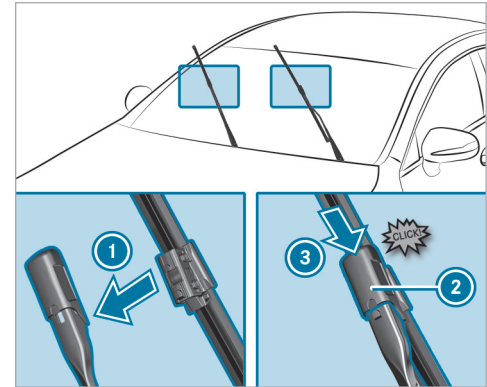

- ▶ Insert the new wiper blade into the wiper arm in the direction of arrow ①.
- ▶ Slide catch ② in the direction of arrow ③ until it engages in the locking position.
- ▶ Make sure that the wiper blade is seated correctly.
- ▶ Fold the wiper arms back onto the windshield.

- ▶ Switch on the vehicle.
 - ▶ Press the  button on the combination switch. The wiper arms will return to their original positions.
 - ▶ Switch off the vehicle.
- ① Check the condition of the wiper blades regularly and replace them in the event of visible damage or ongoing smearing.

Maintenance display

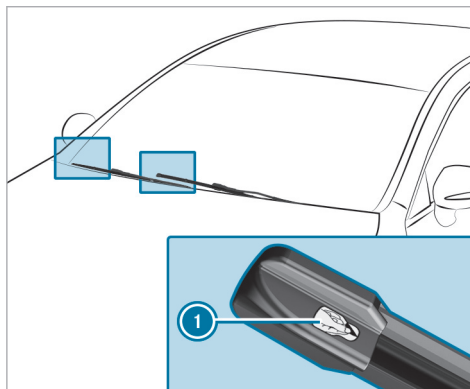

- ▶ Remove protective film ① from the maintenance displays on the tips of the newly installed wiper blades.

When the color of the maintenance displays changes from black to yellow, replace the wiper blades.

- ① The duration until the color changes varies depending on the usage conditions.

Replacing the windshield wiper blades (MAGIC VISION CONTROL)

Moving the wiper arms into the replacement position

- ▶ Switch off the vehicle.
- ▶ Within around 15 seconds, press the  button on the combination switch (→ page 147). The wiper arms will move into the replacement position.

Removing the wiper blades

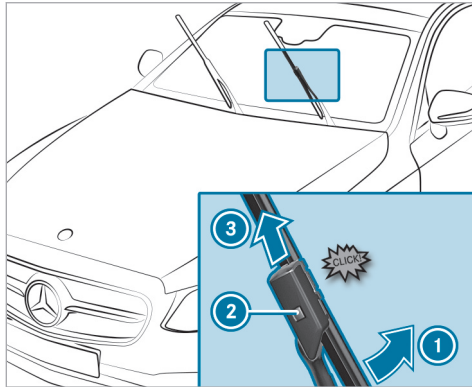

- ▶ **To bring the wiper blade into position to be removed:** hold the wiper arm firmly with one hand. With the other hand, turn the wiper blade in the direction of arrow ① beyond the point of resistance. The wiper blade will engage in the removal position with a click.

- ▶ **To remove the wiper blade:** press release knob ②, pull the wiper blade in the direction of arrow ③ and remove.

Installing the wiper blades

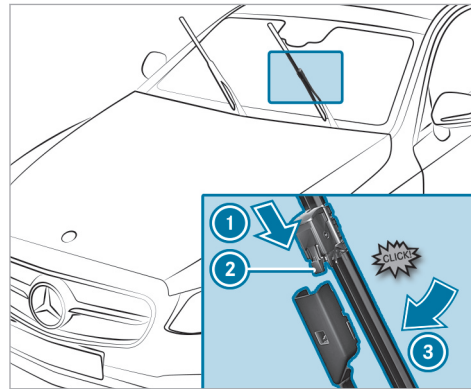

- ▶ Push the new wiper blade onto the wiper arm in the direction of arrow ① until release knob ② engages.

- ▶ Press the wiper blade beyond the point of resistance in the direction of arrow ③ on the wiper arm. The wiper blade will engage with a noticeable click and move freely again.
- ▶ Fold the wiper arm back onto the windshield.
- ① Check the condition of the wiper blades regularly and replace them in the event of visible damage or ongoing smearing.

Replacing the rear window wiper blade

- ⚠ **WARNING** Risk of becoming trapped if the windshield wipers are switched on while wiper blades are being replaced

If the windshield wipers begin to move while you are changing the wiper blades, you can be trapped by the wiper arm.

- ▶ Always switch off the windshield wipers and vehicle before changing the wiper blades.

Removing the wiper blade

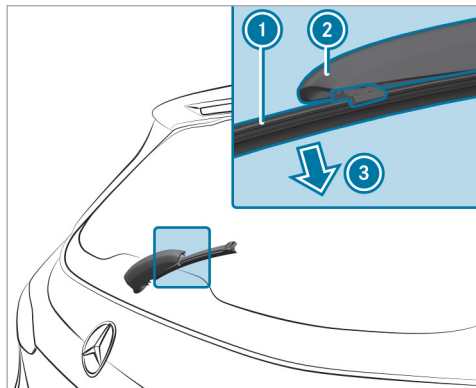

- ▶ Switch off the vehicle.
- ▶ Fold wiper arm ② away from the rear window until it engages in the replacement position.
- ▶ Unclip wiper blade ① from wiper arm ② and remove it in the direction of arrow ③.

Installing the wiper blades

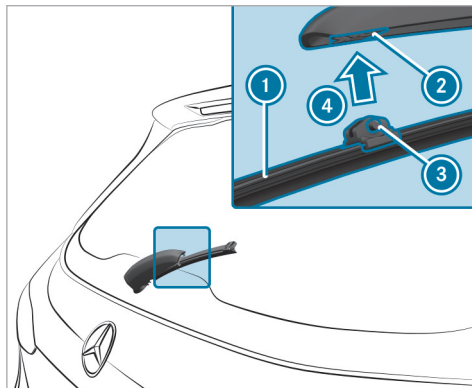

- ▶ Position wiper blade ① with both lugs ③ on holder ② on the wiper arm.
- ▶ Push wiper blade ① in the direction of arrow ④ until it engages in holder ②.
- ▶ Make sure that wiper blade ① is seated correctly.

- ▶ Fold the wiper arm from the replacement position back onto the rear window.

Mirrors

Operating the outside mirrors

⚠ WARNING Risk of accident due to adjusting the vehicle settings while the vehicle is in motion

You could lose control of the vehicle in the following situations in particular:

- If you adjust the driver's seat, the head restraint, the steering wheel or the mirror while the vehicle is in motion
 - If you fasten your seat belt while the vehicle is in motion
- ▶ Before starting the vehicle: in particular, adjust the driver's seat, head restraint, steering wheel and mirror, and fasten your seat belt.

⚠ WARNING Risk of accident due to misjudgment of distance when using the front-passenger mirror

The outside mirror on the front passenger side reflects objects on a smaller scale. The objects in view are in fact closer than they appear.

- ▶ Therefore, always look over your shoulder to check the actual distance between you and the road users traveling behind you.

Folding the outside mirrors in/out

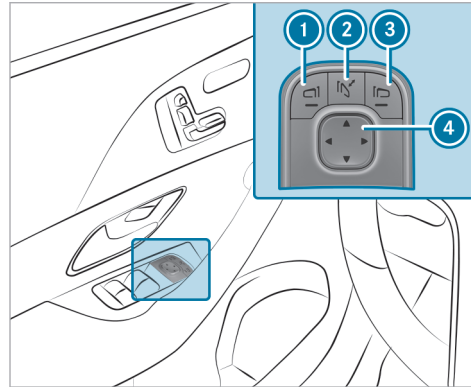

- ▶ Briefly press button ②.

i If the battery has been disconnected or has discharged, the outside mirrors must be moved briefly using button ②. Only then will the automatic mirror folding function work properly.

Adjusting the outside mirrors

- ▶ Press button ① or ③ to select the outside mirror to be adjusted.
- ▶ Use button ④ to adjust the position of the mirror glass.

Engaging the outside mirrors

If an outside mirror has been forcibly disengaged, proceed as follows.

- ▶ Vehicles without electrically folding outside mirrors: manually move the outside mirror into the correct position.
- ▶ Vehicles with electrically folding outside mirrors: press and hold button ②. You will hear a click and the mirror will audibly click into place. The outside mirror will now be set to the correct position.

Automatic anti-glare mirror function

⚠ WARNING Risk of acid burns and poisoning due to the anti-glare mirror electrolyte

Electrolyte may escape if the glass in an automatic anti-glare mirror breaks.

The electrolyte is hazardous to health and causes irritation. It must not come into contact with your skin, eyes, respiratory organs or clothing or be swallowed.

► If you come into contact with electrolyte, observe the following:

- Immediately rinse the electrolyte from your skin with water and seek medical attention.
- If electrolyte comes into contact with your eyes, immediately rinse them thoroughly with clean water and seek medical attention.
- If the electrolyte is swallowed, immediately rinse your mouth out thoroughly. Do not induce vomiting. Seek medical attention immediately.
- Immediately change out of clothing which has been contaminated with electrolyte.
- If an allergic reaction occurs, seek medical attention immediately.

The inside rearview mirror and the outside mirror on the driver's side will automatically go into anti-glare mode if light from a headlamp hits the sensor on the inside rearview mirror.

System limits

The system will not go into anti-glare mode if:

- The vehicle is switched off.
- Reverse gear is engaged.
- The interior lighting is switched on.

Front-passenger outside mirror parking position function

i The parking position is available only in vehicles with a memory function.

The parking position makes parking easier.

In the following situations, the front-passenger outside mirror will swivel downwards in the direction of the rear wheel on the front passenger's side:

- The parking position is stored (→ page 155)
- The front-passenger mirror is selected

- Reverse gear is engaged.

The front-passenger outside mirror will move back to its original position in the following situations:

- You shift the transmission to another transmission position
- You are traveling at speeds greater than 9 mph (15 km/h)
- You press the button for the outside mirror on the driver's side

Storing and calling up the parking position of the front-passenger outside mirror

Storing

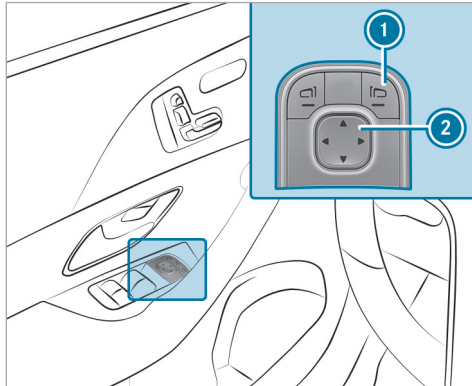

- ▶ Select the front-passenger outside mirror using button ①.
- ▶ Engage reverse gear.
- ▶ Move the front-passenger outside mirror into the desired parking position using button ②.

Calling up

- ▶ Select the front-passenger outside mirror using button ①.
- ▶ Engage reverse gear.
The front-passenger outside mirror will move into the stored parking position.

Activating/deactivating the automatic mirror folding function

Multimedia system:

- ▶ ▶ Settings ▶ Vehicle
- ▶ Open/Close
- ▶ Activate or deactivate Automatic Mirror Folding.

Area permeable to radio waves on the windshield

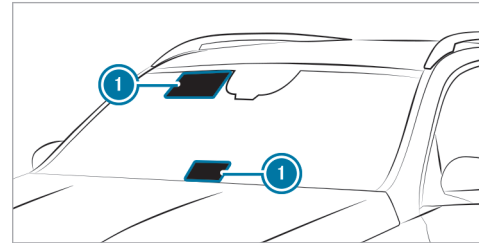

Radio-controlled equipment such as toll systems can be mounted only on areas ① of the windshield that are permeable to radio waves.

Areas permeable to radio waves ① are best visible from outside the vehicle when the windshield is illuminated with an external light source.

Note this position for vehicles with:

- Infra-red reflective windshield

Infrared-reflective windshield function

The infrared-reflective windshield is coated and reduces the build-up of heat in the vehicle interior.

The coating shields the vehicle interior from radio waves.

Overview of climate control systems

Notes on climate control

An interior air filter in combination with the prefilter in the engine compartment must always be used so that the air conditioning system, pollution level monitoring and the air filtration work correctly. Use filters recommended and approved by Mercedes-Benz. Always have maintenance work carried out at a qualified specialist workshop.

Overview of the air conditioning control panel

The indicator lamps on the buttons indicate that the corresponding function is activated.

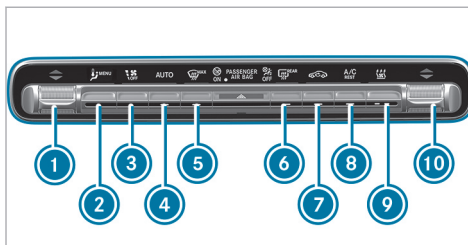

Control panel for dual-zone automatic climate control with stationary heater (example)

- ① Sets the temperature on the driver's side
- ② Calls up/exits the air conditioning menu
Pressing and holding (approx. four seconds); resets climate control to the basic settings
- ③ Sets the airflow or switches off climate control
- ④ **AUTO** Sets climate control to automatic mode (→ page 159)
- ⑤ Defrosts the windshield
- ⑥ Switches the rear window heater on/off

- ⑦ Switches air-recirculation mode on/off (→ page 160)
- ⑧ Switches the A/C function on/off (→ page 158)
Switches residual heat on/off (→ page 160)
- ⑨ Control panel for vehicles with dual-zone or 3-zone automatic climate control without stationary heater: **SYNC** switches synchronization on/off (→ page 160)
Vehicles with control panel for dual-zone or 3-zone automatic climate control with stationary heater: switches stationary heater on/off
- ⑩ Sets the temperature on the front passenger side

Overview of the rear operating unit

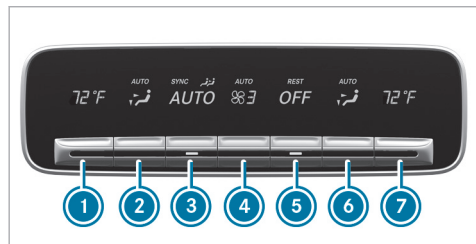

Example: USA

- ① Sets the temperature, left
- ② Sets the air distribution, left
- ③ Sets climate control to automatic mode (→ page 159)
- ④ Setting the airflow
- ⑤ Switches climate control on/off (→ page 158)
Switching residual heat on/off (→ page 161)
- ⑥ Sets the air distribution, right
- ⑦ Sets the temperature, right

The settings for the second and third row of seats can be made via the rear operating unit, multimedia system (→ page 159) or MBUX rear tablet depending on the vehicle's equipment.

Operating the climate control system

Switching climate control on/off

- ▶ **To switch on:** set the airflow to level 1 or higher using the button.
- ▶ **To switch off:** set the airflow to level 0 using the button.

If climate control is switched off, the windows may fog up more quickly. Switch climate control off only briefly.

Switching the climate control in the rear passenger compartment on/off

- ▶ Press button ⑤.
- ① When climate control in the second seat row is switched off, the indicator lamp is activated and **OFF** is shown on the rear display.

Switching the A/C function on/off using the air conditioning control panel

The A/C function heats, cools and dehumidifies the vehicle's interior air.

- ▶ Press the button.

Switch off the A/C function only briefly; otherwise, the windows may fog up more quickly.

Condensation may drip from the underside of the vehicle when cooling mode is active. This is not indicative of a malfunction.

Calling up the air conditioning menu via the climate bar or the air conditioning control panel

The air conditioning menu can be called up via the climate bar. The climate bar is always shown on the lower edge of the media display.

- ▶ Select the **Climate Menu** entry in the air conditioning bar.

Activating/deactivating the A/C function via the air conditioning menu

Multimedia system:

↳ Climate Menu ▶▶ First Row of Seats

Depending on the external conditions, support for improved cooling and dehumidification of the interior air will be provided when the A/C function is activated. If it is not possible to operate the A/C function on the climate bar on the central display, switch the function on or off in the climate menu of the central display.

▶ Select A/C (A/C).

Sets climate control to automatic mode

In automatic mode, the set temperature is controlled and maintained at a constant level by the air supply.

▶ Press button **AUTO** .

▶ **To switch to manual mode:** press the **AUTO** button.

In automatic mode, you can choose between five different air quantities using the  button. Automatic mode is retained.

Automatically controlling the climate control in the rear passenger compartment

In automatic mode, the set temperature is regulated by the temperature of the dispensed air and the airflow.

▶ Press button **AUTO** .

Setting air distribution using the air conditioning menu

Multimedia system:

↳ Climate Menu

▶ Select **First Row of Seats** or **Second Row of Seats**.

▶ To set the air distribution: select , , or .

▶ Set the airflow.

i When the air conditioning system is switched on, at least one zone is always active. How-

ever, several air distribution options can be selected at the same time, for example to set the climate control for the interior and the footwells simultaneously. In doing so, the  climate control for the windshield can only be selected for the first seat row. When automatic mode is active, the buttons for setting the air distribution are automatically deactivated. When the air conditioning system is switched off, the buttons remain operable and the last setting is saved.

Setting rear climate control using the air conditioning menu

Multimedia system:

↳ Climate Menu

Setting the temperature



▶ Set the temperature.

Setting the airflow

▶ Set the airflow.

Controlling the rear climate control automatically

▶ Select **AUTO**.

- ⓘ When the defrost function is activated, some functions (e.g. the temperature setting) will automatically be deactivated. To deactivate the defrost function, press either ,  or  set the air flow to level 0.

Deactivating rear climate control

- ▶ Select **REAR OFF**.

Switching the synchronization function on/off via the air conditioning control panel

Requirements

- The vehicle is not fitted with a stationary heater.

Climate control can be set centrally using the synchronization function. The temperature and air distribution setting for the driver's side will be adopted automatically for all climate control zones.

- ▶ Press the  button.

The synchronization function will be deactivated if the settings for one of the other climate zones are changed.

Switching the synchronization function on/off via the air conditioning menu

Multimedia system:



- ➔ **Climate Menu** ➔ **First Row of Seats**

The synchronization function controls the climate control centrally. The driver's settings for temperature, airflow and air distribution are automatically adopted for each climate zone.

- ▶ Select **SYNC** (SYNC).

Defrosting the windows

Windows fogged up on the inside

- ▶ Press the  button.
- ▶ If the windows remain fogged up: press the  button.

Windows fogged up on the outside

- ▶ Switch on the windshield wipers.
- ▶ Press the  button.

Switching air-recirculation mode on/off

- ▶ Press the  button.
The interior air will be recirculated.

Air-recirculation mode automatically switches to fresh air mode after a while.

- ⓘ If air-recirculation mode is switched on, the windows may fog up more quickly. Switch on air-recirculation mode only briefly.

Switching the residual heat on or off

Requirements:

- The vehicle is parked.

It is possible to make use of the residual heat from the engine to continue heating or ventilating the front compartment of the vehicle for approximately 30 minutes, depending on the temperature set.

- ▶ **To activate:** press  button.

Residual heat will be switched off automatically.

Switching the residual heat in the rear passenger compartment on/off

Requirements

- The vehicle is parked.

When the residual heat of the engine is activated in the rear passenger compartment, you can heat or ventilate the rear passenger compartment for approximately 30 minutes.

- ▶ Press button  (→ page 158).

Activating/deactivating ionization

Multimedia system:

- ▶  Climate Menu ▶▶ Air Quality

When ionization is activated, the interior air is enriched with negatively charged oxygen ions. This can promote the well-being of the vehicle occupants.

- ▶ Select **Ionization**.

- ⓘ The function can be performed only if AUTO mode is activated or the air distribution is set to the side air vent. The function is restricted

if the side air vents on the driver's side are closed.

Fragrance system

Activating/deactivating the fragrance system using the multimedia system

Requirements

- Automatic climate control is activated.
- The glove compartment will close.
- A flacon is inserted.

Multimedia system:

- ▶  Climate Menu ▶▶ Air Quality

The fragrance system distributes a pleasant fragrance throughout the vehicle interior from a flacon located in the glove compartment.

- ▶ Navigate down until the climate control bar is active.
- ▶ Select **Fragrance**.
- ▶ Activate or deactivate fragrancing.

Setting the fragrance system using the multimedia system

Requirements

- A flacon is inserted.
- The glove box will close.
- Climate control is activated.

Multimedia system:

- ▶  Climate Menu ▶▶ Air Quality

The fragrance system distributes a pleasant fragrance throughout the vehicle interior from a flacon located in the glove box.

- ▶ Select **Fragrance**.
- ▶ Keep pressing until the desired intensity is reached.

Inserting or removing the flacon of the fragrance system

⚠ WARNING Risk of injury from liquid perfume

If children open the flacon, they could drink the liquid perfume or it could come into contact with their eyes.

- ▶ Do not leave children unattended in the vehicle.
- ▶ Consult a doctor immediately if liquid perfume has been drunk.
- ▶ If liquid perfume comes into contact with your eyes or skin, rinse your eyes with clean water.
- ▶ If symptoms continue, consult a doctor.



ENVIRONMENTAL NOTE Environmental damage due to improper disposal of full flacons



Full flacons must not be disposed of together with household waste.



Hand in full flacons at a pollutant collection point.

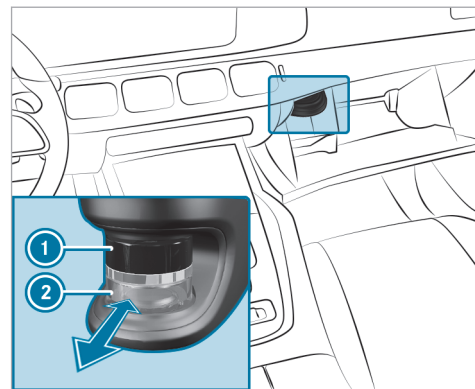

- ① Cap
- ② Flacon

- ▶ **To insert:** slide the flacon into the holder as far as it will go.
- ▶ **To remove:** after opening the glove compartment, wait for approximately seven seconds and pull out the flacon.

If you do not use genuine Mercedes-Benz interior perfumes, observe the manufacturers' safety notices on the perfume packaging.

Dispose of the genuine Mercedes-Benz interior perfume flacon when it is empty and do not refill it.

Refillable flacon

- ▶ Unscrew the cap of the empty flacon.
- ▶ Fill the flacon with a maximum of 0.5 fl. oz. (15 ml).
- ▶ Screw the cap back onto the flacon.

Always refill the empty refillable flacon with the same perfume. Observe the separate information sheet that comes with the flacon.

Pre-entry climate control via the SmartKey (plug-in hybrid)

■ Function of pre-entry climate control via the SmartKey (plug-in hybrid)

Before you get into the vehicle, the driver's side or the whole vehicle interior can be briefly pre-warmed or pre-cooled.

For pre-cooling, the following functions are activated as needed:

- Automatic climate control
- Blower
- Seat ventilation

For pre-heating, the following functions are activated as needed:

- Automatic climate control
- Blower
- Seat heating
- Steering wheel heater
- Panel heating
- Mirror heater
- Rear window defroster
- Wiper park position heater
- Fragrancing
- Ionization

■ Setting pre-entry climate control when the vehicle is unlocked in the multimedia system

Multimedia system:

▶  Climate Menu ▶▶ Pre-entry Climate Ctrl.

- ▶ Activate or deactivate the function.

Selecting seats

- ▶ Select **Driver, Passenger, Rear Left** or **Rear Right**.

The seat-specific functions of pre-entry climate control, such as seat heating, will be performed for the selected seats.

If pre-entry climate control is enabled, an LED on the climate bar of the media display will light up blue for a cooled vehicle and red for a heated vehicle.

■ Activating/deactivating pre-entry climate control via the SmartKey (plug-in hybrid)

Requirements:

- The high-voltage battery is charged sufficiently.
- The function has been activated via the multimedia system.

- ▶ **To switch on:** unlock the vehicle. The climate control functions are activated for up to five minutes for pre-heating and pre-cooling.

Pre-entry climate control via the SmartKey cannot be activated more than twice when the vehicle is switched off.

- ▶ **To switch off:** push the  button up or down.

The following functions will remain active once the vehicle has been started:

- Seat heating
- Seat ventilation
- Panel heating
- Fragrancing
- Ionization

Pre-entry climate control for departure time (plug-in hybrid)

Function of pre-entry climate control for departure time (plug-in hybrid)

⚠ WARNING Risk of fatal injury due to exposure to extreme heat or cold in the vehicle

If persons, particularly children, are subjected to prolonged exposure to intense heat or cold, there is a risk of severe injury or even death.

- ▶ Never leave persons, particularly children, unattended in the vehicle.

The vehicle interior can be air conditioned when the vehicle is parked.

When the vehicle is connected to power supply equipment, priority is given to charging the high-voltage battery to a specified minimum charge.

The running time of pre-entry climate control may be reduced under the following conditions:

- The vehicle is not connected to power supply equipment.

- The high-voltage battery is not charged sufficiently.

With active pre-entry climate control, the charge level of the high-voltage battery may be reduced, even if the charging cable connector is connected.

For cooling, the following functions are activated as needed:

- Automatic climate control
- Blower
- Seat ventilation

For heating, the following functions are activated as needed:

- Automatic climate control
- Blower
- Seat heating
- Steering wheel heater
- Panel heating
- Mirror heater
- Rear window defroster
- Fragrancing

- Ionization

Setting pre-entry climate control for departure time via the multimedia system

Multimedia system:

→ Climate Menu → Pre-entry Climate Ctrl.

Setting the departure time

- ▶ Select **Edit Departure Time** .
- ▶ Select a departure time or set a new departure time.

Setting the repeat days

- ▶ Select **Edit Departure Time** .
- ▶ Set the desired departure time and select the corresponding weekdays on which this departure time is to apply.
- ▶ Press **OK** to confirm.

Selecting seats

- ▶ Select **Driver, Passenger, Rear Left** or **Rear Right**.
Pre-entry climate control will take place for the selected seats.

Activating/deactivating pre-entry climate control for departure time (plug-in hybrid)

Requirements:

- The high-voltage battery is charged sufficiently.
- The function has been activated via the multimedia system.

▶ **To activate:** set the departure time (→ page 165).
Pre-entry climate control for departure time will switch on a maximum of 55 minutes before the selected departure time. It will remain active for another five minutes if departure is delayed.

▶ **To deactivate:** press the  button up or down.

The following functions will remain active once the vehicle has been started:

- Seat heating
- Seat ventilation
- Panel heating
- Fragrancing

- Ionization

Activating/deactivating immediate pre-entry climate control

⚠ WARNING Risk of fatal injury due to exposure to extreme heat or cold in the vehicle

If persons, particularly children, are subjected to prolonged exposure to intense heat or cold, there is a risk of severe injury or even death.

- ▶ Never leave persons, particularly children, unattended in the vehicle.

Air conditioning of the vehicle interior can continue for up to 50 minutes, e.g. if the journey is interrupted.

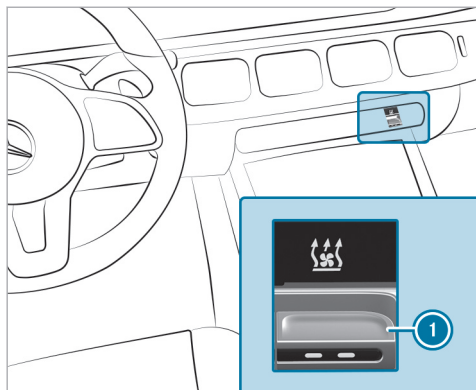

The colors of the indicator lamp have the following meanings:

- **Blue:** cooling is activated.
- **Red:** heating is activated.
- **Yellow:** the departure time has been preselected.

▶ Set the desired temperature using the ▼▲ button.

- ▶ Press button ①.
The red or blue indicator lamp on button ① will light up or go out.

Air vents

Adjusting the front air vents

⚠ WARNING Risk of burns or frostbite due to being too close to the air vents

Very hot or very cold air can flow from the air vents.

- ▶ Make sure that all vehicle occupants always maintain a sufficient distance from the air vents.
- ▶ If necessary, direct the airflow to another area of the vehicle interior.

To guarantee the flow of fresh air through the air vents into the vehicle interior, note the following:

- Always keep the vents and ventilation grilles in the vehicle interior clear.
- Keep the air inlet free of residue build-up (→ page 378).

- Optimum climate comfort is achieved with the air vents in the center position.

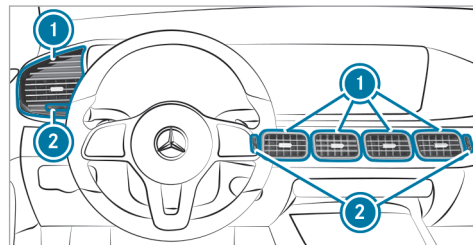

- ▶ **To open or close center air vents:** turn controller ② up or down as far as it will go.
- ▶ **To open or close side air vents:** turn controller ② to the left or right as far as it will go.
- ▶ **To adjust the air direction:** hold air vent ① in the center and move it up or down or to the left or right.

Adjusting the rear passenger compartment air vents

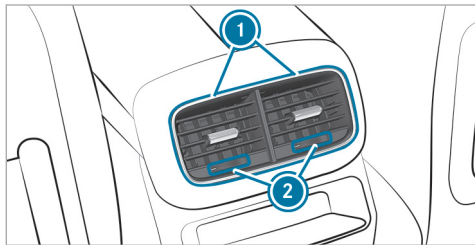

- ▶ **To open or close:** turn controller ② to the left or right as far as it will go.
- ▶ **To set the airflow direction:** hold the center of air vent ① and move it up or down or to the left or right.

Opening or closing the air vent in the glove box

NOTE Damage to temperature-sensitive objects in the glove box

Temperature-sensitive objects stored in the glove box may be damaged by the air vent located inside it.

- ▶ Close the air vent when you heat the vehicle.
- ▶ At high outside temperatures, open the air vent and switch on the A/C function.

The automatic climate control must be switched on to cool the glove box.

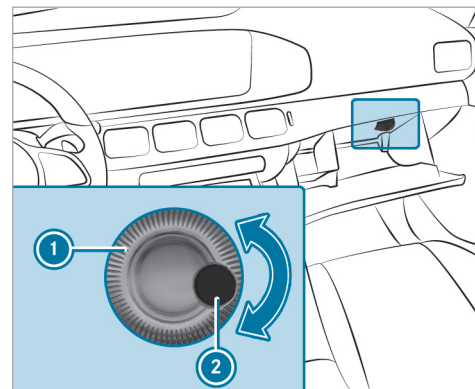

- ▶ **To open or close:** turn controller ① of air vent ② clockwise or counter-clockwise.

Driving

Notes on Mercedes-AMG vehicles

Observe the notes on the following topics in the Supplement, otherwise you may fail to recognize dangers.

i The availability of certain functions depends on the equipment and model of the vehicle.

- Emotion Start
- AMG Real Performance Sound
- AMG ceramic high-performance composite brake system
- AMG RIDE CONTROL +
- AMG ACTIVE RIDE CONTROL
- AMG steering-wheel buttons

Notes on plug-in hybrids

Notes on plug-in hybrid operation

⚠ WARNING Risk of chemical burns and poisoning from damaged high-voltage battery

If the housing of the high-voltage battery has been damaged, electrolyte and gases may leak out.

- ▶ Avoid contact with the skin, eyes or clothing.
- ▶ Immediately rinse electrolyte splashes off with water and seek medical attention straight away.

⚠ DANGER Risk of fire and explosion from excessive internal pressure of the high-voltage battery

In the event of a vehicle fire, flammable gas can escape and ignite.

- ▶ If there is an unusual smell, smoke or burn marks, stop the charging process immediately.

- ▶ Leave the danger zone immediately. Secure the danger area at a sufficient distance.
- ▶ Call the fire service.

! NOTE Mercedes-AMG vehicles

- ▶ Observe the notes in the Supplement. You could otherwise fail to recognize dangers.

The hybrid system combines a combustion engine with an electric motor.

Characteristics when the vehicle is at a standstill:

- The combustion engine is generally switched off.
- Idle speed occurs only in certain instances.

Characteristics when the vehicle is started:

- If the high-voltage battery is sufficiently charged, the vehicle can be started with the electric drive system without the combustion engine (noiseless start).

- If the high-voltage battery for the electric drive system is not sufficiently charged or the vehicle conditions for a silent start are not met, the vehicle will start with the combustion engine.
- ① Depending on the system, it may happen that even though the high-voltage battery is charged, electric mode has restricted or no availability. Once the combustion engine has been operated for long enough and ambient conditions permit, electric mode is again available without restriction.

Characteristics with moderate power output requests:

- The combustion engine is switched off as often as possible during the journey.
- The vehicle can, depending on the drive program selected and the state of charge of the high-voltage battery, be accelerated electrically up to a speed of approximately 87 mph (140 km/h).

Characteristics with high power output requests:

- The electric motor supports the combustion engine (boost effect), e.g. when you pull away or accelerate.
- The high-voltage battery is discharging.

Characteristics when the accelerator pedal is released during the journey:

- The electric motor is used as an alternator when in overrun mode and during braking.
- The high-voltage battery is being charged.

Notes on electric mode:

- Vehicles with hybrid systems generate significantly less noise when stationary and when being driven than vehicles with combustion engines.
- When you are driving in electric mode, the vehicle may not be heard by other road users due to the significantly reduced noise generated when the car is in motion and when at a standstill.

For this reason the vehicle is equipped with a sound generator, which serves as an acoustic

vehicle alerting system (AVAS). This safety device is prescribed by law.

The external noise of the sound generator is perceptible in the vehicle interior when the vehicle is stationary and at low speeds and does not represent a malfunction.

- If not all of the vehicle conditions for electric mode are met, then the combustion engine is switched on.
- Performance restrictions in electric mode are possible due to the operating temperature of the high-voltage battery and drive system, the ambient temperature and aging of the high-voltage battery.
- In electric mode, the maximum output is not permanently available and may drop to the level of continuous output.

Notes on the acoustic vehicle alerting system:

- The sound generator generates a stationary noise and speed-dependent vehicle noise emissions at a speed of up to around 19 mph (30 km/h).

- This helps other road users, particularly pedestrians and cyclists, to hear your vehicle better.
- When you drive at speeds above 13 mph (20 km/h) the acoustic vehicle alerting system will gradually switch off.

Manually disconnecting the high-voltage on-board electrical system

⚠ DANGER Risk of death and fire due to modified and/or damaged components of the high-voltage on-board electrical system

The vehicle's high-voltage on-board electrical system is under high voltage. If you modify component parts in the vehicle's high-voltage on-board electrical system or touch damaged component parts, you may be electrocuted. In addition, modified and/or damaged components may cause a fire.

In the event of an accident or impact to the vehicle underbody, components of the high-voltage electrical system may be damaged although the damage is not visible.

- ▶ Never make any modifications to the high-voltage on-board electrical system.
- ▶ Do not switch on or use the vehicle if its high-voltage on-board electrical system components have been modified or damaged.
- ▶ Never touch damaged components of the high-voltage on-board electrical system.
- ▶ After an accident, do not touch any components of the high-voltage on-board electrical system.
- ▶ After an accident, have the vehicle transported away.
- ▶ Have the components of the high-voltage on-board electrical system checked at a qualified specialist workshop and replaced if necessary.

Requirements

Disconnect the high-voltage on-board electrical system manually only in the following situations:

- The  restraint system warning lamp lights up in the driver's display, e.g. after an accident.
- The vehicle is badly damaged, e.g. after an accident, and the restraint system components have not been triggered.

Operating the high-voltage disconnect device

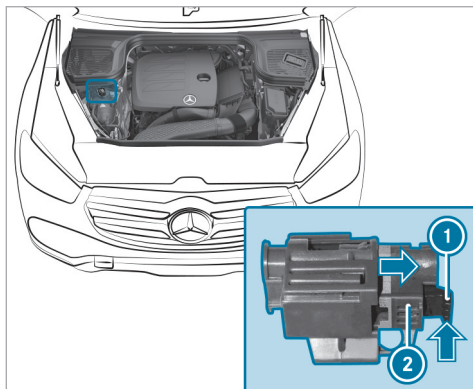

- ▶ Switch off the vehicle.
- ▶ Shift the transmission to position **P**.
- ▶ Apply the electric parking brake.
- ▶ Secure the vehicle against rolling away.
- ▶ Open the hood.

- ▶ Press release tab **1** in the direction of the arrow and pull it out.
- ▶ Pull high-voltage disconnect device **2** in the direction of the arrow until it engages. The high-voltage on-board electrical system is switched off.

All work on the hybrid drive system (including after disconnecting the high-voltage on-board electrical system manually) may be performed only in a qualified specialist workshop.

Switching on the power supply or the vehicle

⚠ WARNING Risk of accident and injury due to children left unattended in the vehicle

If you leave children unattended in the vehicle, they could, in particular:

- open doors, thereby endangering other persons or road users.
- get out and be struck by oncoming traffic.
- operate vehicle equipment and become trapped, for example.

In addition, the children could also set the vehicle in motion by, for example:

- releasing the parking brake.
 - changing the gearbox position.
 - starting the vehicle.
- ▶ Never leave children unattended in the vehicle.
 - ▶ When leaving the vehicle, always take the key with you and lock the vehicle.
 - ▶ Keep the key out of reach of children.

Requirements

- The key is in the vehicle and is recognized.
- The brake pedal is not depressed.

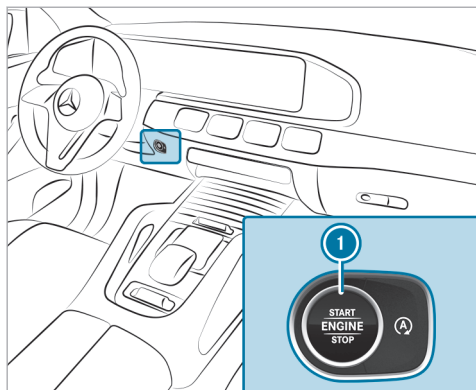

- ▶ **To switch on the power supply:** press button ① once.
You can, for example, switch on the windshield wipers.

The power supply will be switched off again if the following conditions are met:

- You open the driver's door.
- You press button ① twice more.

- ▶ **To switch on the vehicle:** press button ① twice.
Indicator and warning lamps will light up on the driver's display.

The vehicle will be switched off again if one of the following conditions is met:

- You do not start the vehicle within 15 minutes and the transmission is in position **P** or the electric parking brake is applied.
- You press button ① once.

Starting the vehicle

Starting the vehicle with the start/stop button

- ⚠ **DANGER** Risk of death caused by exhaust gases

Combustion engines emit poisonous exhaust gases such as carbon monoxide. Inhaling these exhaust gases is hazardous to health and leads to poisoning.

- ▶ Never leave the engine or, if present, the auxiliary heating running in an enclosed space without sufficient ventilation.

- ⚠ **WARNING** Risk of fire due to flammable materials in the engine compartment or on the exhaust system

Flammable materials may ignite.

- ▶ Therefore, regularly check that there are no flammable foreign materials in the engine compartment or on the exhaust system.

Requirements

- The key is in the vehicle and is recognized.
- ▶ Shift the transmission to position **P** or **N**.
- ▶ Depress the brake pedal and press button ① once.
- ▶ If the vehicle does not start: switch off non-essential consumer equipment and press button ① once.
- ▶ If the vehicle still does not start and the [Place the Key in the Marked Space See Operator's](#)

Manual display message appears on the driver's display: start the vehicle with the key in the marked space (emergency operation mode) (→ page 173).

- i** You can switch off the vehicle while driving. To do this, press and hold button **1** for about three seconds or press button **1** three times within three seconds. Be sure to observe the safety notes concerning this under "Driving tips" (→ page 176).

Observe any information regarding display messages that may be shown on the driver's display.

Starting the vehicle with the key in the marked space (emergency operation mode)

If the vehicle does not start and the **Place the Key in the Marked Space** See Operator's Manual message appears on the driver's display, you can start the vehicle in emergency mode.

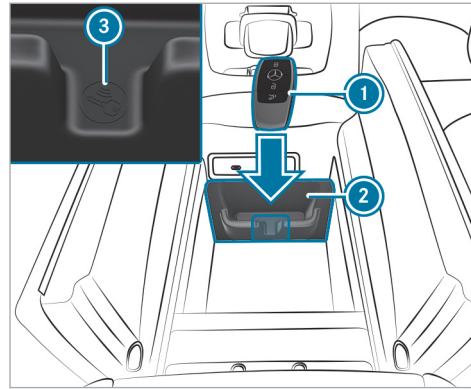

- ▶ Make sure that marked space **2** is empty.
 - ▶ Remove key **1** from the key ring.
 - ▶ Place key **1** in marked space **2** next to symbol **3**.
The vehicle will start after a short time.
- If you remove key **1** from marked space **2**, the vehicle can still be driven. For further engine starts, however, key **1** must be loca-

ted in marked space **2** next to symbol **3** during the entire journey.

- ▶ Have key **1** checked at a qualified specialist workshop.

If the vehicle does not start:

- ▶ Place key **1** in marked space **2** and leave it there.
- ▶ Depress the brake pedal and start the vehicle using the start/stop button.

- i** You can switch on the power supply or the vehicle with the start/stop button.

Observe any information regarding display messages that may be shown on the driver's display.

Starting the vehicle via Remote Online Services

Cooling or heating the vehicle interior before starting the journey

Ensure the following before starting the engine:

- The legal stipulations in the area where your vehicle is parked allow engine starting via smartphone.

- It is safe to start and run the engine where your vehicle is parked.
- The fuel tank is sufficiently full.
- The starter battery is sufficiently charged.

■ Charging the starter battery before starting the journey

You can receive a message on your smartphone when the state of charge of the starter battery is low. You can then start the vehicle with the smartphone to charge the battery. The vehicle is automatically switched off after ten minutes.

Ensure the following before starting the engine:

- The legal stipulations in the area where your vehicle is parked allow engine starting via smartphone.
- It is safe to start and run the engine where your vehicle is parked.
- The fuel tank is sufficiently full.

■ Starting the vehicle (Remote Online)

▲ WARNING Risk of crushing or entrapment due to unintentional starting of the engine

Limbs could be crushed or trapped if the engine is started unintentionally during service or maintenance work.

- ▶ Always secure the engine against unintentional starting before carrying out maintenance or repair work.



Requirements

- Park position **P** is selected.
- The anti-theft alarm system is not activated.
- The panic alarm is not activated.
- The hazard warning light system is switched off.
- The hood is closed.
- The doors are closed and locked.
- The windows and sliding sunroof are closed.

- ▶ Start the vehicle using the smartphone. After every engine start, the engine runs for ten minutes.

You can carry out a maximum of two consecutive starting attempts. You must start the engine with the key before trying to start the vehicle again with the smartphone.

You can switch off the vehicle at any time as follows:

- Via the smartphone app
 - By pressing the  or  button on the key
- i** Further information can be found in the smartphone app.

Securing the vehicle against starting before carrying out maintenance or repair work:

- ▶ Switch on the hazard warning light system or unlock the doors.
- ▶ Open a side window or the sliding sunroof.

Notes on breaking-in a new vehicle

To preserve the engine during the first 1000 miles (1500 km):

- Drive at varying road speeds and engine speeds.
- No faster than 85 mph (140 km/h).
- Drive the vehicle in drive program **C** or **E**.
- Shift to the next gear up when the needle reaches the last third before the red range on the tachometer at the very latest.
- Do not shift down manually to brake.
- Avoid overstraining the vehicle, e.g. driving at full throttle.
- Do not depress the accelerator pedal past the point of resistance (kickdown).
- Increase the engine speed only gradually and accelerate the vehicle to full speed only after 1000 miles (1500 km).

This also applies when the engine or parts of the drivetrain have been replaced.

Please also observe the following breaking-in notes:

- With certain handling and driving safety systems, the sensors will adjust automatically while a certain distance is being driven after the vehicle has been delivered or after repairs. Full system effectiveness will be reached only once this teach-in process has concluded.
- Brake pads, brake disks and tires that are either new or have been replaced will achieve optimum braking performance and grip only after several hundred kilometers of driving. Compensate for the reduced braking effect by applying greater force to the brake pedal.

Notes on optimizing acceleration

If all necessary requirements and activation conditions are fulfilled, the best possible acceleration can be achieved from a standstill.

Do not use optimized acceleration on public roads. Individual wheels could spin and you could lose control of the vehicle. There is an increased risk of skidding and/or accident.

Be sure to observe the safety notes and information on ESP® (→ page 231).

Pulling away with optimized acceleration

⚠ WARNING Risk of skidding and accidents due to the wheels spinning

If you pull away using optimized acceleration, individual wheels can spin and the vehicle can skid.

There is an increased risk of skidding and accidents, especially when ESP® is switched off!

▶ Make sure that there are no persons or obstacles in the vicinity of the vehicle.

Requirements

- the vehicle is run in (→ page 175).
- the vehicle and tires are in good condition.
- the roadway has a high-grip surface.
- the engine and transmission are at normal operating temperature.

! **NOTE** Increased wear due to optimized acceleration

When pulling away with optimized acceleration, all components of the drivetrain are subjected to a very high load.

This can lead to increased component wear.

- ▶ Do not always pull away with optimized acceleration.

- ▶ Engage the **D** drive position (→ page 198).
- ▶ Move the steering wheel to the straight-ahead position.
- ▶ Select the **S** drive program (→ page 194).
- ▶ Deactivating ESP® (→ page 233).
- ▶ Depress and hold the brake pedal firmly with your left foot.
- ▶ With your right foot, fully depress the accelerator pedal.

- ▶ After no more than five seconds, take your left foot quickly off the brake, but keep the accelerator pedal depressed. The vehicle will pull away at maximum acceleration.
- ▶ Switch on ESP® once the acceleration procedure is complete.

Ending optimized acceleration

- ▶ Remove your foot from the accelerator pedal.
- ▶ Reactivate ESP®.
- ⓘ After you pull away with optimized acceleration, components of the drivetrain can become very hot, which means that optimized acceleration values may only be reached again after a few minutes.

Notes on driving

! **WARNING** Risk of accident due to objects in the driver's footwell

Objects in the driver's footwell may impede pedal travel or block a depressed pedal.

This jeopardizes the operating and road safety of the vehicle.

- ▶ Stow all objects in the vehicle securely so that they cannot get into the driver's footwell.
- ▶ Always install the floor mats securely and as prescribed in order to ensure that there is always sufficient room for the pedals.
- ▶ Do not use loose floor mats and do not place floor mats on top of one another.

! **WARNING** Risk of accident due to incorrect footwear

Incorrect footwear includes, for example:

- Shoes with platform soles
- Shoes with high heels
- Slippers

There is a risk of an accident.

- ▶ Always wear suitable footwear so that you can operate the pedals safely.

⚠ WARNING Risk of accident if the vehicle is switched off while driving

If you switch off the vehicle while driving, safety functions are restricted or no longer available.

This may affect the power steering system and the brake force boosting, for example.

You will need to use considerably more force to steer and brake, for example.

- ▶ Do not switch off the vehicle while driving.

⚠ DANGER Risk of death caused by exhaust gases

Combustion engines emit poisonous exhaust gases such as carbon monoxide. Inhaling these exhaust gases is hazardous to health and leads to poisoning.

- ▶ Never leave the engine or, if present, the auxiliary heating running in an enclosed space without sufficient ventilation.

⚠ WARNING Risk of skidding and of an accident due to shifting down on slippery road surfaces

If you shift down on slippery road surfaces to increase the engine braking effect, the drive wheels may lose traction.

- ▶ Do not shift down on slippery road surfaces to increase the engine braking effect.

⚠ DANGER Risk of fatal injury due to poisonous exhaust gases

If the tailpipe is blocked or sufficient ventilation is not possible, poisonous exhaust gases such as carbon monoxide may enter the vehicle. This is the case, for example, if the vehicle gets stuck in the snow.

- ▶ Keep the tailpipe and the area around the vehicle free from snow when the engine or the stationary heater is running.

- ▶ Open a window on the side of the vehicle facing away from the wind to ensure an adequate supply of fresh air.

⚠ WARNING Risk of accident and injury due to being under the influence of alcohol and drugs while driving

Drinking and driving and/or taking drugs and driving are very dangerous combinations. Even a small amount of alcohol or drugs can affect your reflexes, perceptions and judgment.

The possibility of a serious or even fatal accident are greatly increased when you drink or take drugs and drive.

- ▶ Do not drink or take drugs and drive or allow anyone to drive who has been drinking or taking drugs.

⚠ WARNING Risk of accident due to the brake system overheating

If you leave your foot on the brake pedal when driving, the brake system may overheat.

This increases the braking distance and the brake system can even fail.

- ▶ Never use the brake pedal as a footrest.
- ▶ Do not depress the brake pedal and the accelerator pedal at the same time while driving.

! **NOTE** Engine damage due to excessively high engine speeds

The engine will be damaged if you drive with the engine in the overrevving range.

- ▶ Do not drive with the engine in the overrevving range.

! **NOTE** Wearing out the brake linings by continuously depressing the brake pedal

- ▶ Do not depress the brake pedal continuously whilst driving.
- ▶ To use the braking effect of the engine, shift to a lower gear in good time.

! **NOTE** Damage to the drivetrain and engine when pulling away

- ▶ Do not warm up the engine while the vehicle is stationary. Pull away immediately.
- ▶ Avoid high engine speeds and driving at full throttle until the engine has reached its operating temperature.

! **NOTE** Damage to the catalytic converter due to non-combusted fuel

The engine is not running smoothly and is misfiring.

Non-combusted fuel may get into the catalytic converter.

- ▶ Only depress the accelerator pedal slightly.
- ▶ Have the cause rectified immediately at a qualified specialist workshop.

! **NOTE** Reduced battery life due to frequent short-distance trips

The 12 V battery may not be sufficiently charged when the vehicle is used only for short-distance trips. This reduces the life of the battery.

- ▶ Drive longer distances regularly to charge the battery.

! **NOTE** Damage to the vehicle due to not observing the maximum permitted headroom clearance

If the vehicle height is greater than the maximum permitted headroom clearance, the roof and other parts of the vehicle may be damaged.

- ▶ Observe the signposted headroom clearance.
- ▶ If the vehicle height is greater than the permitted headroom clearance, do not enter.

- ▶ Observe the changed vehicle height with add-on roof equipment.

i Please bear in mind that all the speed values stated in this Operator's Manual are approximate and are subject to a certain tolerance.

Notes on driving with a roof load, trailer or fully laden vehicle

When driving with a loaded roof luggage rack or trailer as well as with a fully laden or fully occupied vehicle, the vehicle's driving and steering characteristics change.

You should therefore bear the following in mind:

- Do not exceed the permissible roof load and towing capacity. Also observe the information in the Technical Data.
- Distribute the roof load and the load inside the vehicle evenly, placing heavy objects at the bottom. Also comply with the notes on loading the vehicle (→ page 119).
- Drive attentively, and avoid abrupt starts, braking and steering as well as rapid cornering.

Advice on driving on salt-strewn roads

The braking effect is limited on salt-strewn road surfaces.

Therefore, observe the following notes:

- Due to salt build-up on the brake disks and brake pads, the braking distance can increase considerably or result in one-sided braking.
- Maintain a much greater safety distance to the vehicle traveling in front.

Remove salt build-up as follows:

- Brake occasionally, paying attention to the traffic conditions
- Carefully depress the brake pedal at the end of the journey and when starting the next journey

Notes on hydroplaning

Hydroplaning can take place if a certain depth of water has built up on the road surface.

Observe the following notes during heavy precipitation or in conditions in which hydroplaning may occur:

- Reduce speed

- Avoid tire ruts
- Avoid sudden steering movements
- Brake carefully

i Also observe the notes on regularly checking wheels and tires (→ page 414).

Notes on driving through water on the road

Water ingress can damage the engine, electrics and transmission.

Water can also enter the air intake of the engine and cause engine damage.

Observe the following if you have to drive through water:

- Observe the maximum permissible depth for driving through water (→ page 462).
- Drive at a walking pace at most; water can otherwise enter the vehicle interior or engine compartment.
- Vehicles traveling in front, or oncoming vehicles, can create waves which may exceed the maximum permissible depth of water.

The braking effect of the brakes is reduced after fording. Brake carefully, paying attention to the

traffic conditions until braking power has been fully restored.

Notes on off-road driving

⚠ WARNING Risk of accident if you do not keep to line of fall on inclines

If you drive at an angle or turn on an incline, the vehicle could slip sideways, tip and roll-over.

- ▶ Always drive on inclines in the line of fall (straight up or down) and do not turn.

⚠ WARNING Risk of fire caused by flammable material on hot exhaust system components

Flammable material such as leaves, grass or twigs may ignite if they come into contact with hot parts of the exhaust system.

- ▶ When driving on an unpaved road or off-road, check the vehicle underside regularly.

- ▶ In particular, remove trapped plant parts or other flammable material.
- ▶ If there is damage, consult a qualified specialist workshop immediately.

When driving off-road, sand, mud and water etc., also mixed with oil, may get into the brakes. This may lead to a reduction in braking effect or even a total brake failure as a result of increased wear. The braking characteristics will vary depending on the material that has entered the system. Clean the brakes after driving off-road. If you then notice reduced braking effect or hear scraping noises, have the brake system checked at a qualified specialist workshop. Adapt your driving style to the changed braking characteristics.

! NOTE Damage caused by driving over obstacles

The vehicle can be damaged by:

- Driving onto high curbs or unpaved roads.
- Quickly driving over obstacles such as curbs, speed bumps or potholes.

- Heavy objects hitting the underbody or chassis components.

- ▶ Do not drive over obstacles that could damage the vehicle.
- ▶ Check the vehicle regularly for damage during off-road driving.
- ▶ Adjust the vehicle speed to suit the road surface conditions.
- ▶ If there is damage, consult a qualified specialist workshop immediately.

🔥 ENVIRONMENTAL NOTE Environmental damage due to non-observance of prohibition signs

Environmental protection has priority. Treat nature with respect.

- ▶ Be sure to observe prohibition signs.

Checklist before driving off-road

Check the following points before driving off-road:

- Fuel level

- Engine oil level: fill engine oil to the maximum level to ensure full gradeability (→ page 375)
- Tire-change tool kit and spare wheel
- Tires and wheels

 Further information about special all-terrain tires for retrofitting can be obtained from a qualified specialist workshop.

The off-road menu in the multimedia system can support you when driving off-road. Familiarize yourself with its displays and equipment-dependent setting options before driving off-road (→ page 338).

Off-road driving

Read this section before driving your vehicle off-road. Practice by driving over gentler off-road terrain first.

- Observe the notes on the off-road ABS (→ page 230).
- Select the  (→ page 194) drive program before driving off-road.
- Select a vehicle level suitable for off-road terrain (→ page 268). To avoid damaging the

vehicle, make sure there is always sufficient ground clearance.

The high-voltage battery in particular can be damaged by bottoming out or by impacts against the underbody. Please also observe the notes on operating safety (→ page 29).

- Always keep the engine running and the vehicle in gear when driving on inclines and slopes. Observe the notes on driving in mountainous terrain.
- Do not drive on unknown terrain that is not easily visible and stay on marked paths.
- Always keep the doors and windows closed while the vehicle is in motion.
- Deactivate Active Distance Assist DISTRONIC and cruise control.
- Adapt your driving style to the terrain.
- Do not use the HOLD function on steep downhill or uphill gradients with slippery or loose surfaces.

Driving on sand

When driving on sand, also observe the following instructions:

- Select the  drive program.
- Select a higher vehicle level.
- Shift to a lower gear.
- Drive quickly to overcome the rolling resistance; the vehicle may otherwise dig itself in.
- Drive in the tracks of other vehicles if possible. Make sure that the following prerequisites are met:
 - the tire ruts are not too deep.
 - the sand is firm enough.
 - there is sufficient ground clearance.

Fording

Also observe the following information when fording:

- **Vehicles with AIRMATIC:** select the highest possible vehicle level (→ page 268).
- **Vehicles with E-ACTIVE BODY CONTROL:** select the highest possible vehicle level (→ page 276).

- Drive no faster than 6 mph (10 km/h).
- Observe the maximum permissible fording depth (→ page 462).
- Switch off automatic climate control (→ page 159).
- Ensure that a bow wave does not form as you drive.
- Do not stop in the water and do not switch off the engine. Ensure the ECO start/stop function is switched off (→ page 183).

Driving in mountainous terrain

Also observe the following information when driving in mountainous terrain:

- Observe the values of the approach/departure angle and the maximum gradient-climbing ability (→ page 462).
- Avoid high engine speeds.
- Use the braking power of the engine when driving downhill.
- Shift to a lower gear on uphill gradients and on long, steep downhill gradients.

- Activate DSR before driving downhill, if necessary (→ page 246).

Check-list after driving off-road

Driving off-road places greater demands on your vehicle than driving on normal roads. Check the entire vehicle for damage and foreign bodies every time after driving off-road. Foreign bodies in the wheels or drivetrain can lead to imbalances and therefore vibrations.

- If the  driving mode is selected: select another driving mode.
- Deactivate DSR.
- Lower the vehicle level again to a level suitable for the road conditions, e.g. to the normal level.
- Apply the brakes to dry them after fording.
- Check that the service brake is working normally after a long downhill stretch.
- Clean the following components every time after driving off-road:
 - license plate number
 - headlamps and tail lamps

- tires, wheels and wheel arches
- underbody

- After driving through sand, mud, water or gravel, have the following components checked and cleaned:
 - brake disks and brake pads
 - tires and wheels
 - axle joints

ECO start/stop function

■ ECO start/stop function

- ❗ **Plug-in hybrid:** this function is not available.
- ❗ Depending on the engine, the ECO start/stop function is not available in all drive programs. Observe the status display on the driver's display concerning this.

The engine will be switched off automatically in the following situations if all vehicle conditions for an automatic engine stop are met:

- You brake the vehicle to a standstill in transmission position **D** or **N**.

- You depress the brake pedal when traveling at a low speed.

If the system has detected one of the following situations, the engine will not stop:

- You stop at a stop sign and there is no vehicle in front of you.
- The vehicle that stopped in front of you starts up again.
- You maneuver, turn the steering wheel sharply or engage reverse gear.





i If the system detects an intelligent stop inhibitor, e.g. a stop sign, the engine will not stop. If you activate the HOLD function or engage the park position **P**, the engine can be switched off in spite of an intelligent stop inhibitor.

The engine will restart automatically in the following cases:

- You engage transmission position **D** or **R**.
- You depress the accelerator pedal.
- The vehicle requires an automatic engine start.

- You release the brake pedal.
- You release the brake pedal on a downhill gradient and the vehicle does not roll.
- The vehicle rolls on a downhill gradient and does not automatically enter glide mode at 15 mph (20 km/h).

ECO start/stop function symbols on the driver's display:

- The  symbol (green) appears when the vehicle is at a standstill: the engine was switched off by the ECO start/stop function.
- The  symbol (yellow) appears when the vehicle is at a standstill: not all vehicle conditions for an engine stop have been met.
- Neither the  symbol nor the  symbol appears when the vehicle is at a standstill: an intelligent stop inhibitor, e.g. a stop sign, has been detected.
- The  symbol appears: the ECO start/stop function is deactivated or there is a malfunction.

If the engine was switched off by the ECO start/stop function and you leave the vehicle, a warning tone will sound and the engine will not be restarted. In addition, the following display message will appear on the driver's display:

Vehicle Ready to Drive Switch the Ignition Off Before Exiting

If you do not switch off the vehicle, it will automatically be switched off after three minutes.

Switching the ECO start/stop function on/off

i NOTE Mercedes-AMG vehicles

- ▶ Observe the notes in the Supplement. You could otherwise fail to recognize dangers.

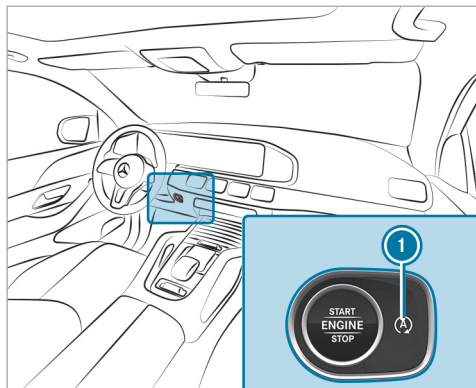

▶ Press button ①.
A display will appear on the driver's display when you switch the ECO start/stop function on/off.

①  will be continuously shown on the driver's display while the ECO start/stop function is deactivated.

ECO display function

① Depending on the model and equipment, your vehicle has one of the following representations of the ECO display.

The ECO display summarizes your driving characteristics from the start of the journey to its completion and assists you in achieving the most economical driving style.

The ECO display assesses the following criteria for an economical driving style:

- coasting at the right times
- consistent speed
- moderate acceleration

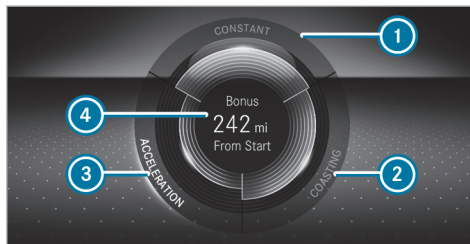

The lettering in the segment will light up brightly, the outer edge will light up and the segment will fill up when the following driving style is adopted:

- ① Steady speed
- ② Gentle deceleration and rolling
- ③ Moderate acceleration

The lettering in the segment will be gray, the outer edge will be dark and the segment will empty when the following driving style is adopted:

- ① Fluctuations in speed
- ② Heavy braking
- ③ Sporty acceleration

The ECO display will show you when you have driven economically:

- The three segments will fill up completely at the same time
- The edges around all three segments will light up

The additional range achieved as a result of your driving style in comparison with a driver with a very sporty driving style will be shown in the cen-

ter of display ④. The range displayed does not indicate a fixed reduction in consumption.

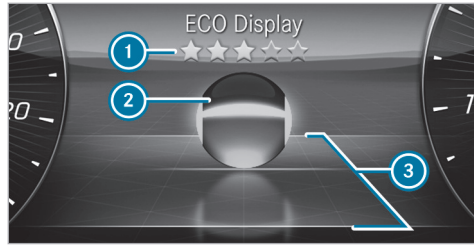

The ECO display shows an evaluation of your driving style on the driver's display depending on the situation. This enables you to check the efficiency of your driving style and adjust it if necessary. The **ECO Display** menu shows a ball ② that will roll forwards or backwards on a stylized road in the direction of travel according to the driving characteristics.

Above and below the road, lines mark the area for an efficient driving style ③. Ball ② will light up in green if it is rolling within these lines. Outside the lines, the ball will light up in orange.

The overall assessment of your driving style "from start" is indicated using stars ①. It starts with five empty stars, which you can fill one after the other if you drive efficiently. When all five stars are filled, a glow will appear in the background.

① You can call up the **ECO Display** function via the **Classic** menu (→ page 307).

ECO Assist function (vehicles with 48 V on-board electrical system)

① ECO Assist is active only in drive programs **[E]** and **[C]**.

ECO Assist analyzes data for the vehicle's expected route. This allows the system to optimally adjust the driving style for the route ahead, save fuel and recuperate. If the system detects an event ahead and the vehicle nears the event, ECO Assist will calculate the optimum speed for maximum fuel economy and recuperative energy based on the distance, speed and downhill gradient.

If the deceleration provided by ECO Assist is not sufficient, you must also brake with the service brake. This is especially the case if, for example,

you pull away again in slow-moving traffic and the distance to the vehicle in front is very short.

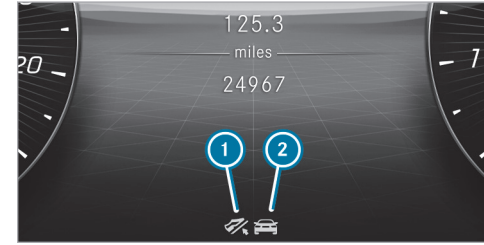

- ① "Foot off the accelerator" recommendation
- ② Route event ahead



If a route event ahead or a vehicle driving in front that require an adjustment to your driving style for greater efficiency are detected, corresponding symbol ② and the  symbol (gray) will be displayed.





If you release the accelerator pedal, the  symbol will turn green and recuperation in overrun mode will be initiated. If the deceleration is not sufficient, also apply the service brake. If ECO

Assist intervenes for a route event ahead (not for a vehicle in front) and you then press the accelerator pedal again, you end ECO Assist's control.

The ECO Assist display is hidden again in the following cases:

- You do not react to the ECO Assist recommendation for a long time.
- You press the accelerator pedal while ECO Assist is intervening for a route event ahead (not for a vehicle in front).
- ECO Assist cannot identify any further recommendations from the route ahead.

In addition to a vehicle in front , ECO Assist can detect the following route events  depending on the vehicle's equipment:

-  Traffic circle
-  T-intersection
-  Downhill gradient
-  Speed limit

-  In the  drive program, ECO Assist only reacts to route event "Vehicle in front" without

a display of the  route event and the  recommendation.

System limits

If the calculated route is adhered to when route guidance is active, ECO Assist will operate with greater accuracy. The basic function is also available without active route guidance. Not all information and traffic situations can be foreseen. The quality depends on the map data.

ECO Assist is only an aid. The driver is responsible for keeping a safe distance from the vehicle in front, for vehicle speed and for braking in good time.

The system may be impaired or may not function in the following situations:

- If there is poor visibility, e.g. due to insufficient illumination of the road, highly variable shade conditions, rain, snow, fog or heavy spray.
- If there is glare, e.g. from oncoming traffic, direct sunlight or reflections.
- If the windshield is dirty in the vicinity of the multifunction camera.

- If the multifunction camera is fogged up, damaged or obscured.
- If road signs are hard to detect, e.g. due to dirt, snow or insufficient lighting, or because they are obscured.
- If the information in the navigation system's digital map is incorrect or out of date.
- If signs are ambiguous, e.g. road signs in road-works or in adjacent lanes.
- If the radar sensors are dirty or obscured.
- When you drive on roads with steep uphill or downhill gradients.
- If there are narrow vehicles in front, such as bicycles or motorcycles.

Regenerative brake system (plug-in hybrid)

Function of the recuperative brake system

Depending on the selected recuperation level, the electric motor is operated as an alternator when in overrun mode and during braking in order to charge the high-voltage battery while driving. As soon as you take your foot off the accelerator pedal when the vehicle is in motion and in trans-

mission position **D**, recuperation in overrun mode is initiated.

The higher the recuperation, the more sharply the vehicle is braked when coasting and the more electrical energy is fed into the high-voltage battery.

The deceleration in overrun mode may not be sufficient depending on the driving conditions. Decelerating to a standstill is not possible. Also brake with the service brake if necessary. Always adapt your speed to the driving conditions and keep a sufficient distance.

The recuperative brake system has the following characteristics:

- supports braking with electronically controlled brake force boosting
- converts the kinetic energy of the vehicle into electric energy

i If you brake hard, the mechanical brake is also used. This means that the maximum recuperative energy cannot be recovered. The more you drive and brake in an anticipatory

manner, the more efficiently energy can be recuperated.

System limits

The braking effect of the electric motor during recuperation in overrun mode may be reduced or may not be available at all in the following situations:

- when the high-voltage battery charge level increases
- if the high-voltage battery is not yet at a normal operating temperature

In these cases, the desired deceleration is set by the brake control system.

Manually setting recuperative deceleration

! **NOTE** Mercedes-AMG vehicles

▶ Observe the notes in the Supplement. You could otherwise fail to recognize dangers.

i You can use the steering wheel paddle shifters to adjust the intensity of recuperation in drive programs **H**, **B** and **EL**.

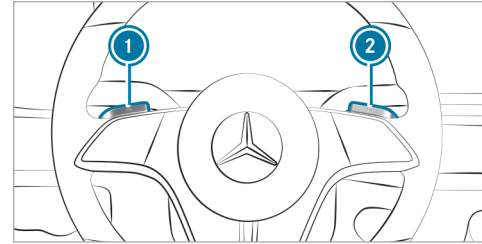

The following recuperation levels are available:

- **D AUTO** Intelligent and anticipatory recuperation with ECO Assist (→ page 188)
- **D +** No recuperation: the vehicle rolls freely
- **D** Normal recuperation
- **D -** Increased recuperation: strong deceleration in overrun mode, e.g. for driving on downhill gradients

Standard setting:

- **[D] AUTO**: if the ECO Assist function is activated in the multimedia system (→ page 189).
 - **[D]**: if the ECO Assist function is deactivated in the multimedia system.
- ① **[D] AUTO** is available only if the ECO Assist function is activated in the multimedia system and if the function of the radar sensors is not impaired. Also observe the information on vehicle sensors and cameras (→ page 228).
- ▶ **To increase recuperation**: briefly pull paddle shifter ①.
- ▶ **To reduce recuperation**: briefly pull paddle shifter ②.
- ▶ **Standard setting**: pull and hold paddle shifter ① or ②, or engage transmission position **[D]** again.
- ① When the vehicle is started again, the standard setting is also set.

The driver's display shows the currently selected recuperation level next to the transmission position display.

ECO Assist (plug-in hybrid)

ECO Assist function

- ① The following function depends on the equipment and the country.

ECO Assist analyzes data for the vehicle's expected route. This allows the system to optimally adjust the driving style for the route ahead, save fuel and recuperate. If the system detects an event ahead and the vehicle nears the event, ECO Assist will calculate the optimum speed for maximum fuel economy and recuperative energy based on the distance, speed and downhill gradient.

If the deceleration provided by ECO Assist is not sufficient, you must also brake with the service brake. This is especially the case if, for example, you pull away again in slow-moving traffic and the distance to the vehicle in front is very short.

The function will be active in the following circumstances:

- The function is activated in the multimedia system (→ page 189).

- The **[D] AUTO** recuperation level is selected (→ page 187).
- **[M]** manual gearshifting is not activated.
- Drive program **[S]** or  is not selected.



- ① "Foot off the accelerator" recommendation
 ② Route event ahead

If a route event that can be dealt with more efficiently by adjusting your driving style is detected ahead, corresponding symbol ② and the  symbol will be displayed in gray.



If you release the accelerator pedal, the  symbol will turn green and recuperation in over-



run mode will be initiated. If the deceleration is not sufficient, also apply the service brake.

If ECO Assist makes adjustments for a route event ahead and you step on the accelerator pedal, ECO Assist control is terminated. This does not apply in the case of a vehicle in front.

The ECO Assist display is hidden again in the following cases:

- You do not react to the ECO Assist recommendation for a long time.
- You press the accelerator pedal while ECO Assist is intervening for a route event ahead. This does not apply in the case of a vehicle in front.
- ECO Assist cannot identify any further recommendations from the route ahead.

In addition to a vehicle in front , ECO Assist can detect the following route events  depending on the vehicle's equipment:

-  Traffic circle
-  S-bend
-  Sharp bend

 T-intersection

 Downhill gradient

 Speed limit

System limits

If the calculated route is adhered to when route guidance is active, ECO Assist will operate with greater accuracy. The basic function is also available without active route guidance. Not all information and traffic situations can be foreseen. The quality depends on the map data.

ECO Assist is only an aid. The driver is responsible for keeping a safe distance from the vehicle in front, for vehicle speed and for braking in good time.

The system may be impaired or may not function in the following situations:

- If there is poor visibility, e.g. due to insufficient illumination of the road, highly variable shade conditions, rain, snow, fog or heavy spray.
- If there is glare, e.g. from oncoming traffic, direct sunlight or reflections.
- If the windshield is dirty in the vicinity of the multifunction camera.

- If the multifunction camera is fogged up, damaged or obscured.
- If road signs are hard to detect, e.g. due to dirt, snow or insufficient lighting, or because they are obscured.
- If the information in the navigation system's digital map is incorrect or out of date.
- If signs are ambiguous, e.g. road signs in road-works or in adjacent lanes.
- If the radar sensors are dirty or obscured.
- When you drive on roads with steep uphill or downhill gradients.
- If there are narrow vehicles in front, such as bicycles or motorcycles.

■ Activating and deactivating ECO Assist

Multimedia system:

  **» Settings » Assistance**
» Driving

 Activate or deactivate the function.

Function of the route-based operating-mode strategy (plug-in hybrid)

- ① The following function is country-dependent and available only in conjunction with an integrated navigation system.

The route-based operating-mode strategy is active under the following conditions:

- Drive program **[H]** is selected.
- The "route based" option (→ page 195) is selected for drive program **[H]** in the **DYNAMIC SELECT** menu.
- Route guidance is active.
- The state of charge of the high-voltage battery is sufficient.

If the function is active, data on the further course of the route is evaluated. This includes e.g. road type, speed limitations and altitude data.

The hybrid system then adapts the operating strategy to the further course of the route:

- Use of electrical energy and the combustion engine is adapted.

- The state of charge of the high-voltage battery is controlled accordingly.
- Electrical energy is reserved especially for electric mode, e.g. urban route sections or low emission zones.
- The vehicle automatically selects the operating mode.

Function of the haptic accelerator pedal (plug-in hybrid)

The haptic accelerator pedal has an additional point of resistance followed by increased pedal resistance to help you drive in all-electric mode. Characteristics of the additional point of resistance:

- Available only in drive program **[EL]**
- Is used when the electric motor power availability display (POWER) is full
- Indicates the maximum available electric performance

The subsequent increased pedal resistance indicates that the journey is being continued with the combustion engine.

DYNAMIC SELECT

Function of DYNAMIC SELECT

! NOTE Mercedes-AMG vehicles

- ▶ Observe the notes in the Supplement. You could otherwise fail to recognize dangers.

DYNAMIC SELECT makes possible the quick selection of a drive program in accordance with the current driving situation or the desired vehicle characteristics. You can select from the following drive programs.

- ① Depending on the engine and equipment, the vehicle has different drive programs.

The drive program selected will appear on the driver's display.

[I*] Individual

- Individual settings (→ page 194)

- Individual settings (plug-in hybrid)
(→ page 195)

S Sport

- The maximum drive output is available
- Sporty driving
- Sporty, but with an emphasis on stability
- Enables a sporty driver to adopt a more active driving style
- Driving with the combustion engine and reinforced boost effect (plug-in hybrid)
- Suitable only for good road conditions, a dry surface and a clear stretch of road
- **Vehicles with AIRMATIC or E-ACTIVE BODY CONTROL:** lowers the vehicle to low level -1
- **Plug-in hybrids with AIRMATIC:**
 - adjusts the vehicle to normal level
 - from 87 mph (140 km/h): lowers the vehicle to low level -1
 - below 25 mph (40 km/h): raises the vehicle to normal level

H Hybrid (plug-in hybrid)

- Comfortable and economical driving
- Balance between traction and stability
- Recommended for all road conditions
- Full development of all intelligent hybrid functions
- Adjustable recuperation in overrun mode
- The selection of the appropriate drive type by the hybrid system depends on the driving conditions and the distance
- **Vehicles with AIRMATIC:**
 - adjusts the vehicle to normal level
 - from 87 mph (140 km/h): lowers the vehicle to low level -1
 - below 25 mph (40 km/h): raises the vehicle to normal level

C Comfort

- Comfortable and economical driving
- Balance between traction and stability
- Recommended for all road conditions

• **Vehicles with AIRMATIC or E-ACTIVE BODY CONTROL:**

- adjusts the vehicle to normal level
- from 87 mph (140 km/h): lowers the vehicle to low level -1
- below 25 mph (40 km/h): raises the vehicle to normal level

CV Curve

- Available only for vehicles with E-ACTIVE BODY CONTROL
- Comfortable driving with curve tilting function
- Balance between traction and stability
- Recommended for all road conditions
- Adjusts the vehicle to normal level
- Lowers the vehicle at speeds above approx. 87 mph (140 km/h) to low level -1
- Raises the vehicle at speeds below approx. 25 mph (40 km/h)

EL Electric (plug-in hybrid)

- Electric mode – driving without the combustion engine is possible up to approximately 87 mph (140 km/h)
- Adjustable recuperation in overrun mode
- Adaptation of Active Distance Assist DISTRONIC for electric mode
- Depending on the equipment, the maximum set speed for cruise control and Active Distance Assist DISTRONIC can be limited to the maximum speed possible in electric mode
- Activation of the combustion engine via the point of resistance of the accelerator pedal (kickdown)
- **Vehicles with AIRMATIC:**
 - adjusts the vehicle to normal level
 - from 87 mph (140 km/h): lowers the vehicle to low level -1
 - below 25 mph (40 km/h): raises the vehicle to normal level

B Battery Hold (plug-in hybrid)

- Prioritizes maintaining the state of charge of the high-voltage battery, e.g. for subsequent journeys in inner-city/low-emission zones
- The selection of the appropriate drive type by the hybrid system depends on the driving conditions and the distance
- Adjustable recuperation in overrun mode
- **Vehicles with AIRMATIC:**
 - adjusts the vehicle to normal level
 - from 87 mph (140 km/h): lowers the vehicle to low level -1
 - below 25 mph (40 km/h): raises the vehicle to normal level

E Eco

- Particularly economical driving
- Balance between traction and stability
- Recommended for all road conditions
- **Vehicles with AIRMATIC or E-ACTIVE BODY CONTROL:**
 - adjusts the vehicle to normal level

- from 87 mph (140 km/h): lowers the vehicle to low level -1
- below 25 mph (40 km/h): raises the vehicle to normal level

**Offroad**

- For driving off-road, e.g. on dirt tracks, loose surfaces, gravel or sand, as well as on difficult, uneven terrain, where there are no firm road surfaces and over rocky terrain
- Intervenes later if there is oversteer or understeer, thus improving traction
- Not suitable for use on public roads
- Can be selected up to a maximum of 62 mph (100 km/h)
- From 68 mph (110 km/h): switch to **C**
- **Vehicles with AIRMATIC or E-ACTIVE BODY CONTROL:**
 - Below 37 mph (60 km/h): raises the vehicle to off-road level +1
 - Lowers the vehicle at speeds above approx. 50 mph (80 km/h) to normal level and

Raises the vehicle again at speeds below approx. 30 mph (45 km/h) to off-road level +1

- When the system switches to **C**: lowers the vehicle to normal level

- **Vehicles with Off-road package:**

- Below 56 mph (90 km/h): raises the vehicle to off-road level +1
- When the system switches to **C**: lowers the vehicle to normal level and

At speeds below approx. 47 mph (75 km/h), it is possible to select  again

Below speeds of approx. 37 mph (60 km/h), you can also manually raise the vehicle, depending on equipment, to an off-road level (→ page 268).

- **Plug-in hybrid:**

- From 68 mph (110 km/h): switch to **H** and lowers the vehicle to normal level
- Driving in hybrid or electric mode, depending on a sufficient condition of charge of

the high-voltage battery and the setting in the multimedia system (→ page 195)

- ① Depending on the situation, the cylinder can be briefly deactivated in the **E** and **C** drive programs, depending on the engine.
- ① The ESP® settings in the drive programs **E** and **C** are designed for stability. Therefore, choose one of these drive programs especially when transporting roof loads, in trailer operation and when the vehicle is fully loaded or fully occupied.
Plug-in hybrid: This also applies for drive programs **H**, **EL** and **B**.

Depending on the drive program, the following systems will change their characteristics:

- Drive
 - Engine and transmission management
 - Active Distance Assist DISTRONIC
 - Availability of Glide mode
- ESP®
- **Vehicles with AIRMATIC or E-ACTIVE BODY CONTROL:** suspension

- Suspension and damping
- Vehicle level (speed-dependent)
- Steering

Notes on the roof load display

Certain drive programs and ESP® settings are unsuitable for transporting a roof load.

If one of these drive programs is set or selected, the  symbol is shown as a warning. When this symbol is shown, the selected drive program is not suitable for transporting a load on the roof.



The following drive programs are affected:

- Drive program **S** **Sport**
- Drive program **I** **Individual** with the ESP® setting Sport

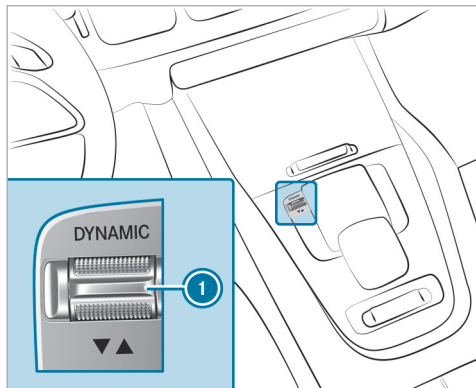
Selecting the drive program



▶ Push DYNAMIC SELECT switch ① forwards or backwards. The drive program selected will appear on the driver's display.

① In the  drive program, some driving systems are restricted in their function or not available. When selecting the  drive pro-

gram, a confirmation prompt therefore appears on the central display before the drive program is activated.

Plug-in hybrid: in the  drive program, you can switch between hybrid and electric mode via the multimedia system (→ page 194).

Configuring DYNAMIC SELECT in the multimedia system

Multimedia system:

→  ▶ Settings ▶ Vehicle
▶▶ DYNAMIC SELECT

Setting drive program I

▶ Select  Individual .

▶ Select and set a category.

① A sporty ESP mode can be set in conjunction with a sporty suspension mode.

Switching the reset display on/off

▶ Activate or deactivate **Request at Start**.

① This function must be activated for each user profile separately. Only when this function is

activated will the drive program and ECO start/stop setting for the previous journey be saved for the respective user profile.

Function on: the next time the vehicle is started a prompt appears asking whether the last active drive program should be restored. If the ECO start/stop function was deactivated, an additional prompt appears asking if the function should remain deactivated.

① The prompt only appears if the previously active settings deviate from the standard settings.

Function off: the next time the vehicle is started the  drive program is set automatically. The ECO start/stop function is activated automatically.

Configuring DYNAMIC SELECT in the MMS (plug-in hybrid and electric vehicles)



Multimedia system:

↳  » Settings » Vehicle
» DYNAMIC SELECT

Setting drive program I

- ▶ Select  Individual.
- ▶ Select and set a category.

Setting the H drive program

- ▶ Select **Hybrid**.
- ▶ Select **Route Based** or **Standard**.
If route guidance is active and the **Route Based** option has been activated, the electrical energy is distributed intelligently over the entire route. In built-up areas, electric mode is preferred, while on the freeway the combustion engine is used.
With the **Standard** option, the vehicle drives in its standard drive program ( **Electric** or  **Hybrid**). There is no distribution of electrical energy over the entire route. The high-



voltage battery is exhausted and the vehicle is then driven by the combustion engine.

Switching the reset display on/off

- ▶ Activate or deactivate **Request at Start**.
- ⓘ This function must be activated for each user profile separately. The drive program for the respective user profile of the last driver is only stored if this function is activated.

Function on: the next time the vehicle is started a prompt appears asking whether the last active drive program should be restored.

- ⓘ The prompt only appears if the previously active settings deviate from the standard settings.

Function off: if the  drive program was the last one active, and all requirements for the drive program are fulfilled, this will be automatically selected the next time the vehicle is started. If another drive program was active, then the  drive program is set automatically.

Function off: the next time the vehicle is started the  drive program is set automatically.

Displaying vehicle data

Multimedia system:

↳  » Info

- ▶ Select **Vehicle**.
The vehicle data is displayed.

Displaying engine data

Multimedia system:

↳  » Info

- ▶ Select **Engine**.
The engine data is displayed.
- ⓘ The actual maximum values that can be achieved for engine output and engine torque may deviate from the certified values within the country-specific guidelines for permissible tolerances (basis: UN-ECE No. 85 or country-specific guidelines).

Variables that can influence this are, for example:

- Sea level
- Fuel quality

- Outside temperature
- Operating temperature of the engine

Adjust your driving style accordingly.

The  warning lamp in the driver's display is on until the engine has reached operating temperature.

- ① The values displayed serve only as orientation. The values for engine output and engine torque shown in the media display may deviate from the actual values.
- ① The  warning lamp to show the power output limitation after starting the vehicle is not available in all vehicle models.

Calling up the fuel consumption indicator

Multimedia system:



- ▶ Select **Consumption**.

The current and average fuel consumption will be displayed.

Automatic transmission

DIRECT SELECT lever

Function of the DIRECT SELECT lever

- ⚠ **WARNING** Risk of accident due to incorrect gearshifting

If the engine speed is higher than the idle speed and you engage the transmission position **D** or **R**, the vehicle may accelerate sharply.

- ▶ If you engage the transmission position **D** or **R** when the vehicle is at a standstill, always depress the brake pedal firmly and do not accelerate at the same time.

- ⚠ **WARNING** Risk of accident and injury due to children left unattended in the vehicle

If you leave children unattended in the vehicle, they could, in particular:

- open doors, thereby endangering other persons or road users.
- get out and be struck by oncoming traffic.
- operate vehicle equipment and become trapped, for example.

In addition, the children could also set the vehicle in motion by, for example:

- releasing the parking brake.
- changing the gearbox position.
- starting the vehicle.

- ▶ Never leave children unattended in the vehicle.
- ▶ When leaving the vehicle, always take the key with you and lock the vehicle.
- ▶ Keep the key out of reach of children.

Use the DIRECT SELECT lever to switch the transmission position. The current transmission position will be shown on the driver's display.

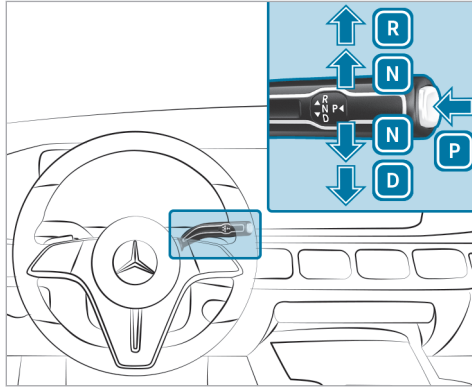

- P** Park position
- R** Reverse gear
- N** Neutral
- D** Drive position

Engaging reverse gear R

- ▶ Depress the brake pedal and push the DIRECT SELECT lever upwards past the first point of resistance.

Engaging neutral N

- ▶ Depress the brake pedal and push the DIRECT SELECT lever up or down to the first point of resistance.

- ⓘ To shift into neutral **N** with the vehicle switched on, push the selector lever up or down for several seconds to the first point of resistance.

Subsequently releasing the brake pedal will allow you to move the vehicle freely, e.g. to push it or tow it away.

Proceed as follows if you want the automatic transmission to remain in neutral **N, even if the vehicle is switched off or the driver's door is opened:**

- ▶ Depress the brake pedal and engage neutral **N** when the vehicle is at a standstill.
- ▶ Release the brake pedal.
- ▶ Switch off the vehicle.

The **Risk of Vehicle Rolling Away N Activated Manually No Automatic Change to P** message appears in the driver's display.

- ⓘ If you then exit the vehicle leaving the key in the vehicle, the automatic transmission remains in neutral **N**.

The park position **P** is automatically re-engaged as soon as one of the following conditions is met:

- You switch to transmission position **D** or **R**.
- You press the button **P**.

Engaging park position P

! **NOTE** Damage due to engaging park position **P** while the vehicle is rolling

If you shift the transmission into park position **P** while the vehicle is rolling, the transmission may be damaged.

- ▶ If the vehicle is rolling, do not open a door.
- ▶ Only engage park position **P** when the vehicle is stationary.

- ▶ Observe the notes on parking the vehicle (→ page 219).
- ▶ Depress the brake pedal until the vehicle comes to a standstill.
- ▶ When the vehicle is stationary, press button **P**.
When the transmission position display shows **P**, the park position is engaged. If the transmission position display **P** does not appear, apply the parking brake and secure the vehicle to prevent it from rolling away.
- ⓘ Depending on the situation, it may take a short time until **P** is engaged. Therefore, always pay attention to the transmission position display.

Park position **P** will be engaged automatically if one of the following conditions is met:

- You switch the stationary vehicle off in transmission position **D** or **R**.
- You open the driver's door when the vehicle is stationary in transmission position **D** or **R**.

- When the vehicle is rolling, you switch it off in transmission position **D** or **R** and bring it to a standstill.
- When the vehicle is rolling, you shift to transmission position **N**, bring the vehicle to a standstill and open the driver's door when the vehicle is stationary.
- Engaging park position **P** automatically is required by the vehicle.
- ⓘ To maneuver with an open driver's door, open the driver's door while the vehicle is stationary and engage transmission position **D** or **R** again.

Engaging drive position D

- ▶ Depress the brake pedal and push the DIRECT SELECT lever down past the first point of resistance.

When the automatic transmission is in transmission position **D**, it will shift gears automatically. This depends, among other things, on the following factors:

- The selected drive program
- The position of the accelerator pedal

- The driving speed

Manual gearshifting

Permanent setting (vehicles with Off-Road package or E-ACTIVE BODY CONTROL)

! NOTE Mercedes-AMG vehicles

- ▶ Observe the notes in the Supplement. You could otherwise fail to recognize dangers.

- ⓘ For vehicles without Off-road package or E-ACTIVE BODY CONTROL, activate or deactivate the permanent setting via the multimedia system (→ page 199).

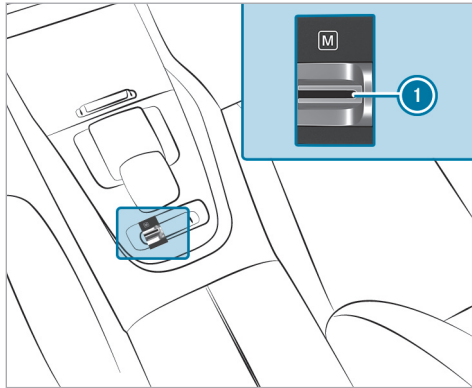

- ▶ **To activate/deactivate:** pull rocker switch ①. If the indicator lamp is lit, manual shifting is activated. The driver's display shows the current gear.

Temporary setting

- ① For plug-in hybrids, observe the information regarding the regenerative brake system (→ page 186).

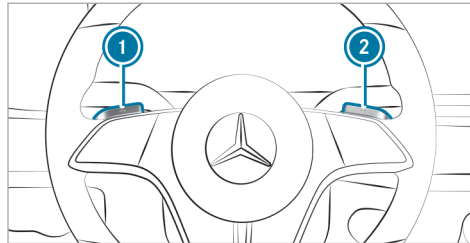

- ▶ **To activate:** pull steering wheel paddle shifter ① or ②. Manual shifting will be activated for a short time. Transmission position **M** and the current gear will appear on the instrument display.
- ▶ **To deactivate:** pull and hold steering wheel paddle shifter ②. Transmission position **D** will appear on the instrument display.
- ① To permanently shift the gears manually in drive program **I_M** using the steering wheel paddle shifters, select the **M** setting for the transmission.

Shifting

- ▶ **To shift up:** pull steering wheel paddle shifter ②.
- ▶ **To shift down:** pull steering wheel paddle shifter ①.

Permanently activating or deactivating manual gearshifting

Multimedia system:

- ▶ ▶ Settings ▶ Vehicle ▶ Driving
- ▶ Permanently switch the function on or off.

Gearshift recommendation

The gearshift recommendation assists you in adopting an economical driving style.



- ▶ If gearshift recommendation ① appears next to the transmission position display, shift to the recommended gear.

Using kickdown

- ▶ **Maximum acceleration:** depress the accelerator pedal beyond the point of resistance.

To protect against excessively high engine speeds, the automatic transmission will shift up to the next gear when maximum engine speed has been reached.

Glide mode function

! NOTE Mercedes-AMG vehicles

- ▶ Observe the notes in the Supplement. You could otherwise fail to recognize dangers.

With an anticipatory driving style, glide mode helps you to reduce fuel consumption.

Glide mode is characterized by the following:

- The combustion engine is disconnected from the drivetrain and is still running in neutral.
- The transmission position display **D** is shown in green.
- **Vehicles with 48 V on-board electrical system:** the combustion engine can be switched off. All of the vehicle functions remain active.

Glide mode will be activated if the following conditions are met:

- Drive program **E** is selected.
- The speed is within a suitable range.

- The road's course is suitable, e.g. no steep uphill or downhill gradients or tight bends.
- There is no trailer attached to the trailer hitch, and no bicycle rack installed.
- You do not depress the accelerator or brake pedal (except for light brake applications).

- ① Glide mode can also be activated if you have selected the "Eco" setting for the drive in drive program **D**.

Glide mode will be deactivated again if one of the conditions is no longer met.

Glide mode can also be prevented by the following parameters:

- Incline
- Downhill gradient
- Temperature
- Height
- Speed
- Operating status of the engine
- Traffic situation

Function of 4MATIC

4MATIC ensures that all four wheels are driven. Together with ESP® and 4ETS, 4MATIC improves the traction of your vehicle whenever a driven wheel spins due to insufficient traction.

If you fail to adapt your driving style, 4MATIC can neither reduce the risk of an accident nor override the laws of physics. 4MATIC cannot take account of road, weather and traffic conditions. 4MATIC is only an aid. You are responsible especially for maintaining a safe distance from the vehicle in front, for vehicle speed, for braking in good time and for staying in lane.

- i In wintry road conditions, the maximum effect of 4MATIC can be achieved only if you use winter tires (M+S tires), with snow chains if necessary.

Refueling

Refueling the vehicle

⚠ WARNING Risk of fire or explosion from fuel

Fuels are highly flammable.

- ▶ Fire, open flames, smoking and creating sparks must be avoided.
- ▶ Before refueling, switch off the vehicle and, if installed, the stationary heater, and leave them switched off during refueling.

⚠ WARNING Risk of injury from fuels

Fuels are poisonous and hazardous to your health.

- ▶ Do not swallow fuel or let it come into contact with skin, eyes or clothing.
- ▶ Do not inhale fuel vapor.
- ▶ Keep children away from fuel.

- ▶ Keep doors and windows closed during the refueling process.

If you or other people come into contact with fuel, observe the following:

- ▶ Immediately rinse fuel off your skin with soap and water.
- ▶ If fuel comes into contact with your eyes, immediately rinse them thoroughly with clean water. Seek medical attention immediately.
- ▶ If you swallow fuel, seek medical attention immediately. Do not induce vomiting.
- ▶ Change immediately out of clothing that has come into contact with fuel.

⚠ WARNING Risk of fire and explosion due to electrostatic charge

Electrostatic charge can ignite fuel vapor.

- ▶ Before you open the fuel filler cap or take hold of the pump nozzle, touch the metallic vehicle body.
- ▶ To avoid creating another electrostatic charge, do not get into the vehicle again during the refueling process.

! **NOTE** Damage caused by the wrong fuel

Vehicles with a gasoline engine:

Even small amounts of the wrong fuel could result in damage to the fuel system, the engine and the emission control system.

- ▶ Only refuel with low-sulfur spark-ignition engine fuel.

This fuel may contain up to 10% ethanol. Your vehicle is suitable for use with E10 fuel.

Never refuel with one of the following fuels:

- Diesel
- Gasoline with more than 10% ethanol by volume, e.g. E15, E85, E100

- Gasoline with more than 3% methanol by volume, e.g. M15, M30, M85, M100
- Gasoline with additives containing metal

If you have accidentally refueled with the wrong fuel:

- ▶ Do not switch on the vehicle.
- ▶ Consult a qualified specialist workshop.

! **NOTE** Do not use diesel to refuel vehicles with a gasoline engine

If you have accidentally refueled with the wrong fuel:

- Do not switch on the vehicle. Otherwise fuel can enter the engine.

Even small amounts of the wrong fuel could result in damage to the fuel system and the engine. The repair costs are high.

- ▶ Consult a qualified specialist workshop.
- ▶ Have the fuel tank and fuel lines drained completely.

! **NOTE** Damage to the fuel system due to overfilling the fuel tank

- ▶ Only fill the fuel tank until the pump nozzle switches off.

If too much fuel has been added due, for example, to a faulty filling pump:

- ▶ Do not switch on the vehicle.
- ▶ Consult a qualified specialist workshop.

! **NOTE** Fuel may spray out when you remove the fuel pump nozzle

- ▶ Only fill the fuel tank until the pump nozzle switches off.

Requirements

- The vehicle is unlocked.
- **Plug-in hybrid with gasoline engine:** The fuel tank was vented before refueling (→ page 203). This function is country-dependent.

Observe the notes on service fluids and fuel.

Refuel only using fuel that has at least the octane number specified on the information label on the fuel filler flap. Otherwise, engine output may be reduced and fuel consumption increased.

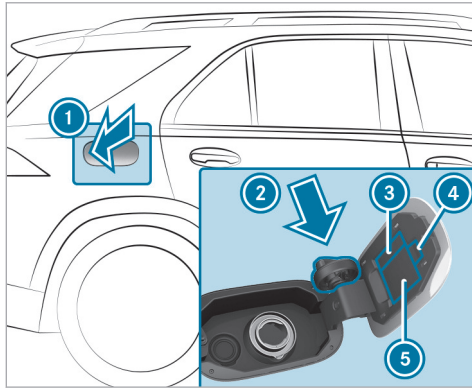

- ① Fuel filler flap
- ② Bracket for fuel filler cap
- ③ Fuel type

- ④ QR code for rescue card
- ⑤ Tire pressure table

ⓘ **Plug-in hybrid with gasoline engine:** The fuel filler flap will open automatically after the fuel tank has been vented (→ page 203).

- ▶ Press on the rear part of fuel filler flap ①.
- ▶ Turn the fuel filler cap counter-clockwise and remove it.
- ▶ Insert fuel filler cap from above into bracket ②.
- ▶ Completely insert the pump nozzle into the tank filler neck, hook in place and refuel.
- ▶ Fill the fuel tank only until the pump nozzle switches off.
- ▶ Replace the cap on the filler neck and turn clockwise until it engages audibly.
- ▶ Close fuel filler flap ①.

Depressurizing the fuel tank (plug-in hybrid with gasoline engine)

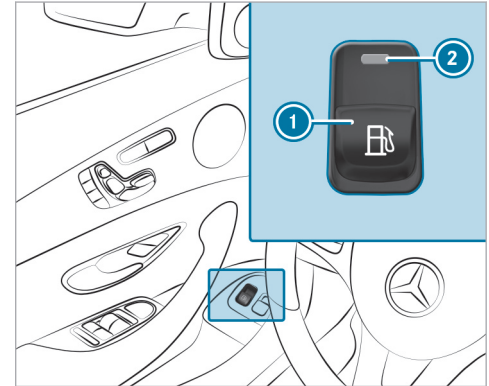



- ▶ Pull switch ① once briefly. Indicator lamp ② will flash and the **Please Wait Depressurizing Fuel Tank** message will appear on the driver's display. When the fuel tank is depressurized, indicator lamp ② lights up continuously.

The **Fuel Tank Is Depressurized Ready for Refueling** message will appear on the driver's display and the fuel filler flap will open automatically.

- ① Depressurizing the fuel tank may take several minutes.

The fuel tank can be depressurized only if the conditions described above are fulfilled. Otherwise, drive the vehicle at least 1 / 3 mile (0.5 km) and repeat the process.

- ① In the following situations, there is a malfunction:
 - Indicator lamp  flashes initially and then goes out.
 - The yellow engine diagnostics warning lamp  lights up.

! **NOTE** Damage to the fuel filler flap when opening it

If an attempt is made to open a fuel filler flap that is not unlocked, the fuel filler flap or the opening mechanism may be damaged.

- ▶ Only refuel when the fuel filler flap has opened automatically.

Charging the high-voltage battery (plug-in hybrid)

Notes on charging the high-voltage battery

- !** **NOTE** High-voltage battery damage due to leaving the vehicle idle for lengthy periods of time

Lithium-ion batteries experience a natural self-discharge.

Exhaustive discharging can therefore occur if the vehicle is idle for several months. This can damage the high-voltage battery.

- ▶ To avoid damage, please observe the following recommendations when handling the high-voltage battery.

- !** **NOTE** Accelerated aging of the high-voltage battery due to not observing the following recommendations

As a result of its basic characteristics, the storage capacity of and the amount of energy available from the high-voltage battery decreases over the course of its life. Due to this, both the maximum electrical range that can be achieved by the vehicle and its maximum electrical output can be impaired.

The following factors could accelerate the aging of the high-voltage battery:

- A high condition of charge, especially if the vehicle is idle for a lengthy period of time
- Frequent rapid charging with direct current (mode 4)
- Leaving the vehicle idle for lengthy periods at high ambient temperatures
- ▶ To avoid accelerated aging, please observe the following recommendations when handling the high-voltage battery.

Recommendations when handling the high-voltage battery:

- Charge the high-voltage battery only with direct current (mode 4) if necessary.
- If leaving the vehicle idle for lengthy periods, park up the vehicle with a high-voltage battery charge level between 25% and 30%. Do not keep the high-voltage battery continuously connected to power supply equipment.
- If leaving the vehicle idle for lengthy periods of time avoid, if possible, high ambient temperatures.
- Check the high-voltage battery's charge level every six weeks (→ page 219).
- Charge the high-voltage battery if the charge level is below 15%.
- Do not disconnect the 12 V battery even if the vehicle is left idle for a lengthy period. Otherwise, the condition of the vehicle's high-voltage battery cannot be monitored.
- If the high-voltage battery is used only with low charge levels, fully charge the high-voltage battery every six months.

You can charge the high-voltage battery with both alternating current (mode 2 or 3) and direct current (mode 4).

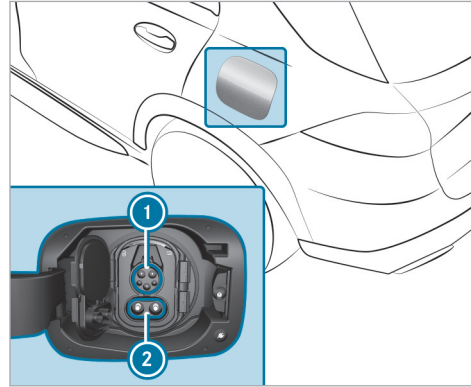

- ① Socket for charging with alternating current
 - ② Socket extension for charging with direct current
- ⓘ When using a CCS (Combined Charging System) charging cable to charge with direct cur-

rent, both areas of the vehicle socket are covered by the charging cable connector.

Charging options for the high-voltage battery (mode 2, 3 or 4):

- Charging through recuperation while the vehicle is in motion
- Charging with alternating current when stationary:
 - at a mains socket (mode 2)
 - at a wallbox or charging station (mode 3)
- Charging with direct current when stationary:
 - at a rapid charging station (mode 4)

Depending on the country-specific vehicle equipment and your vehicle's charging cable, single phase AC charging is also possible.

Observe the different grid requirements of your current location when charging. Use only charging cables that conform to the grid requirements. Consult a qualified electrician or your local grid operator if you have any questions.

It is recommended that you charge the high-voltage battery at a wallbox or charging station due to

the improved charging performance and better charging efficiency offered.

System limits

The power output of the high-voltage battery may be impaired by the following:

- High or low outside temperatures
- Electrical auxiliary consumers in the vehicle being switched on, e.g. operating the air conditioning system
- Extended periods without charging

The charging time or the charging power of the high-voltage battery may be increased by the following:

- High or low outside temperatures
- A high or low state of charge of the high-voltage battery
- The maximum available charge current of the charging facility

Stowing the charging cable

Always stow the vehicle's charging cable in the charging cable bag provided and secure the charging cable bag in the trunk or cargo compartment with the included retaining strap. Otherwise, the charging cable bag with the charging cable is not sufficiently secured.



Example: charging cable bag in the trunk / cargo compartment

As delivered, charging cable bag ① with retaining strap ② is located in the trunk or cargo compartment. To secure the charging cable bag, the retaining strap must be attached to cargo tie-down ring ③. Do not use bag hooks to attach the retaining strap.

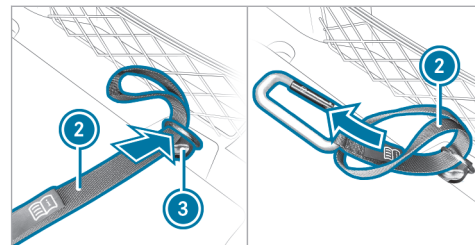

- ▶ Feed the loop end of retaining strap ② through cargo tie-down ring ③ into the trunk or cargo compartment.
- ▶ Feed the end with the snap hook through the loop of retaining strap ②.



- ▶ Tighten retaining strap ② so that the knot around cargo tie-down ring ③ is tight and secure.
- ▶ Hook the snap hook of retaining strap ② in a cargo tie-down ring of charging cable bag ①.

Notes on charging the high-voltage battery at the mains socket (mode 2)

⚠ DANGER Risk of fatal injury from incorrectly installed component parts

Connecting the charging cable to a mains socket using incorrectly installed component parts could cause a fire or an electric shock, for example.

- ▶ Only connect the charging cable to a mains socket that:
 - has been properly installed and
 - has been inspected by a qualified electrician
- ▶ For safety reasons, only use the charging cable supplied with the vehicle or an original Mercedes-Benz charging cable.
- ▶ Purchase these parts at an authorized Mercedes-Benz Center and obtain advice there.

Mercedes-Benz thoroughly tests these original charging cables for their suitability for high-voltage charging of your vehicle.

- ▶ Never use a damaged charging cable.
- ▶ Do not use:
 - extension cables
 - extension reels
 - multiple sockets
- ▶ Never use socket adapters to connect the charging cable to the mains socket. The only exception being if the adapter has been tested and approved by the manufacturer for charging the high-voltage battery of an electric vehicle.
- ▶ Observe the safety notes in the operating instructions for the socket adapter.

Only the following charging cables may be used:

- the charging cable supplied with the vehicle.
- a charging cable that has been approved for the vehicle.

The charging process can vary depending on the power supply equipment. The charging times when charging the high-voltage battery at the mains socket are considerably longer than when charging at a wallbox or charging station.

When doing so, always observe the local information.

Do not leave the charging cable controls hanging loose from a mains socket.

Do not lift the controls by the following component parts:

- the charging cable connector
- the mains plug

When charging, protect the charging cable control element from excessive heat such as direct sunlight. Otherwise, the charging process may be canceled.

Notes on charging the high-voltage battery at a wallbox or charging station (mode 3)

⚠ DANGER Risk of fatal injury from incorrectly installed component parts

Connecting the charging cable to the vehicle using incorrectly installed components could cause a fire or an electric shock, for example.

- ▶ Only connect the charging cable to a wallbox if:
 - The wallbox has been properly installed
 - The wallbox has been inspected by a qualified electrician
 - The charging cable is not damaged
- ▶ Do not extend the charging cable.
- ▶ Do not use adapters.
- ▶ Observe the safety notes in the operating instructions for the wallbox.

⚠ DANGER Risk of fatal injuries due to damaged components

If you use a damaged component to connect the vehicle to the charging station, this can result in fire or an electric shock, for example.

- ▶ Perform a visual inspection of the charging station for obvious defects, e.g. damage to the housing or on the charging cable connection.
- ▶ At charging stations without a pre-installed cable, for safety reasons, only use charging cables that have been tested and approved by the manufacturer for charging the high-voltage battery in an electric vehicle.
- ▶ Do not use a damaged charging cable.
- ▶ Do not use an extension for the charging cable.
- ▶ Do not use an adapter.
- ▶ Always observe the safety information on the charging station.

Most charging stations must be activated before the charging process, e.g. using an RFID card. Observe the on-site operator's instructions for the charging station.

The amount of energy dispensed for the charging process, shown by the charging station, may be higher than the amount of energy actually absorbed by the high-voltage battery. This is the result of different levels of charging losses and is described as recharge efficiency. Charging losses occur, for example, due to heat that builds up when the vehicle is charging or from auxiliary consumers that are switched on. Further information on recharge efficiency can be obtained at a qualified specialist workshop.

Notes on charging the high-voltage battery at a rapid charging station (mode 4)

⚠ DANGER Risk of fatal injuries due to damaged components

If you use a damaged component to connect the vehicle to the charging station, this can result in fire or an electric shock, for example.

- ▶ Perform a visual inspection of the charging station for obvious defects, e.g. damage to the housing or on the charging cable connection.
- ▶ At charging stations without a pre-installed cable, for safety reasons, only use charging cables that have been tested and approved by the manufacturer for charging the high-voltage battery in an electric vehicle.
- ▶ Do not use a damaged charging cable.
- ▶ Do not use an extension for the charging cable.
- ▶ Do not use an adapter.
- ▶ Always observe the safety information on the charging station.

⚠ DANGER Risk of fatal injuries when carrying out maintenance work during the charging process

During the charging process, the high-voltage on-board electrical system is under high voltage.

- ▶ Do not perform any maintenance work during the charging process.

Most charging stations must be activated before the charging process, e.g. using an RFID card. Observe the on-site operator's instructions for the charging station.

The amount of energy dispensed for the charging process, shown by the charging station, may be higher than the amount of energy actually absorbed by the high-voltage battery. This is the result of different levels of charging losses and is described as recharge efficiency. Charging losses occur, for example, due to heat that builds up when the vehicle is charging or from auxiliary consumers that are switched on. Further information on recharge efficiency can be obtained at a qualified specialist workshop.

Setting the maximum permissible charging current for charging at a mains socket

! **NOTE** Overloading the mains socket due to excessive charging current

If the charging current is too high, the fuse could be tripped or the external mains supply could overheat.

- ▶ Make sure that the external mains supply has been designed to handle the set charging current.
- ▶ If necessary, reduce the set charging current or use a different mains socket.
- ▶ For safety reasons, only use the charging cable supplied with the vehicle or an original Mercedes-Benz charging cable. Mercedes-Benz thoroughly tests these original charging cables for their suitability for high-voltage charging of your vehicle. Purchase these parts at an authorized Mercedes-Benz Center and obtain advice there.

Before charging at a mains socket, have the maximum permissible charging current for the relevant mains socket or the building inspected by a qualified electrician. The charging cable supplied is set to a country-specific maximum charging current value. When charging abroad, the maximum value may exceed the permitted value for that country. When abroad, observe the country-specific laws when charging. If you have questions concerning setting the charging current or if there is a malfunction, please contact a qualified specialist workshop.

Overview of the charging cable operating unit

The charging cable operating unit shows the current status of the charging process.

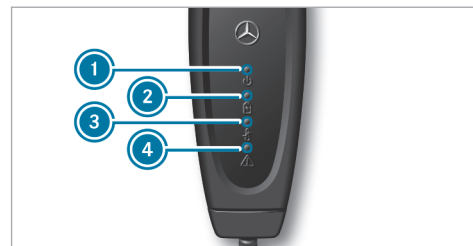

- ① Supply voltage indicator
- ② Charging process indicator
- ③ Temperature monitor indicator
- ④ Safety system indicator

Supply voltage indicator ①

Display	Meaning
Lights up white	The supply voltage is connected.

Charging process indicator ②

Display	Meaning
Flashes green	The high-voltage battery is charging.

Temperature monitor indicator ③

Display	Meaning
Lights up red	The green LED flashes simultaneously: over-temperature – the charging performance is reduced. The green LED does not flash: over-temperature – the charging process is stopped.
Flashes red	Overtemperature at the mains plug – the charging process is stopped.

Safety system indicator ④

Display	Meaning
Flashes red	Charging cable malfunction – cannot carry out the charging process, reset the charging cable operating unit.
Lights up red	White LED is off: power supply malfunction – cannot carry out the charging process, replace the mains socket. White LED is on: vehicle malfunction – cannot carry out the charging process, reset the charging cable operating unit.

When all four displays light up, the charging cable operating unit performs a self-test.

If temperature monitor ③ indicates a malfunction, it may help to protect the charging cable from direct sunlight.

To reset the charging cable operating unit: if safety system ④ indicates a charging cable malfunction or a vehicle malfunction, first reset the charging cable operating unit. To do this, disconnect the charging cable from the vehicle and from the mains socket and wait for approximately five seconds. If the malfunction persists after the charging cable is reconnected, charging at the mains socket is not possible. The charging cable must be replaced or the vehicle plug must be checked at a qualified specialist workshop, depending on the indicator.

Functions of the indicator lamps on the vehicle socket

The socket flap is centrally locked and unlocked together with the vehicle.

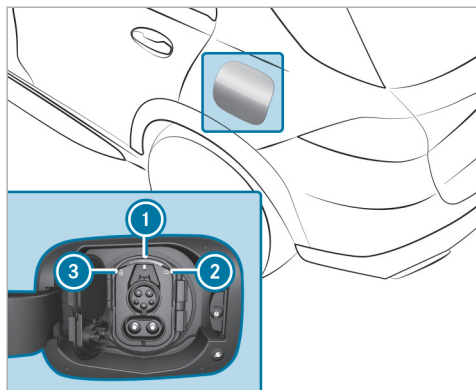

- ① Socket lamp
- ② Charging process indicator lamp
- ③ Locking status indicator lamp

Socket lamp ① flashes or lights up as with indicator lamps ② and ③.

Overview of the locking status

Locking status ③	Display	Meaning
	Lights up white	Vehicle socket unlocked, insert or remove charging cable
	Flashes white	Malfunction during locking or unlocking

Overview of the charging process status

Status of the charging process ②	Display	Meaning
	Flashes orange	Connection is being established
	Flashes green	Active energy flow

Status of the charging process ②	Display	Meaning
	Lights up orange (for approx. 60 s)	Interruption in charging
	Lights up green (for approx. 60 s)	Charging process completed
	Flashes red (for approx. 90 s)	Vehicle malfunction; charging is not possible

Starting the alternating current charging process (mode 2/3)

⚠ DANGER Risk of death when charging at a damaged socket

The charging process uses high voltage.

If the charging cable, the vehicle socket or the mains socket are damaged, you could receive an electric shock.

- ▶ Only use an undamaged charging cable.
- ▶ Avoid mechanical damage such as crushing, abrading or driving over the cable.
- ▶ Have a damaged vehicle socket replaced at a qualified specialist workshop as soon as possible.
- ▶ Never connect the charging cable to a damaged vehicle socket.

! **NOTE** Damage due to overheating of charging cable and charge port

During the charging process, the charging cable and charge port can heat up within the permissible limits.

The permissible limit values are influenced by the following factors:

- the power supply system and the charging cable are not damaged

- the instructions for handling the charging cable and the control element on the charging cable have been observed

- ▶ If the charging cable or charge port becomes too hot, have the power supply system checked.

! **NOTE** Damaged or dirty vehicle socket when the socket flap is open

- ▶ Always keep the socket cover and the socket flap closed when there is no charging cable connected. This protects the vehicle socket from dirt and damage.
- ▶ Make sure that the socket cover is closed properly before closing the socket flap. This can otherwise result in damage which may prevent the socket flap from being opened again.

! **NOTE** Damage to the vehicle socket or the charging cable connector due to incorrect handling

Do not use excessive force (maximum 67.4 lbf (300 N)) to insert the charging cable connector into the vehicle socket as far as it will go. You may otherwise damage the vehicle socket, the charging cable connector or their contacts.

- ▶ If you feel there is increased resistance, pull the charging cable connector out of the socket and reinsert it.

Requirements

- The transmission is in position **P**.
- The vehicle is unlocked or the distance between the key and the vehicle does not exceed 3 ft (1 m).
- The charging cable is not taut.

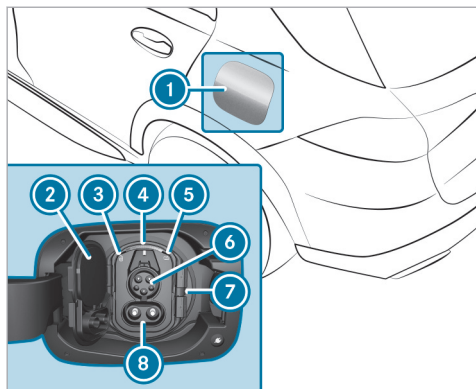

▶ Press the center rear section of socket flap ① and swing the socket flap forwards and open.
The  indicator lamp ③ and upper status display ④ light up white.

① If socket flap ① cannot be opened despite the vehicle being unlocked, the charge socket flap can be opened by emergency release (→ page 218).

▶ Press catch ⑦ to the right and fold up socket cover ②.

① Vehicles with a vehicle socket combo require only connection ⑥ for the charging cable connector. Open only the upper part of socket cover ②.

▶ To charge at a mains socket, insert the mains plug into the mains socket of the external power source as far as it will go.

▶ Insert the charging cable connector into vehicle socket connection ⑥ to the stop. If the wallbox/charging station is not equipped with a charging cable, insert the plug of the vehicle's charging cable into the wallbox/charging station socket to the stop.

Make sure that the charging cable is not taut when inserted.

The  indicator lamp ⑤ and status display ④ flash orange and, as soon as the high-voltage battery is charged, green.

When the charging cable is connected to the vehicle, the vehicle cannot be started or moved.

At the start of the charging process, the charge level display is shown in the driver's display with a charging prediction. The charging prediction refers to the time at which the high-voltage battery will be fully charged.

① Depending on the temperature, the fan and battery cooling system may audibly switch on during the charging process.

① If the vehicle is idle for lengthy periods and connected to the mains supply, the high-voltage battery will be recharged automatically as needed or when electrical consumers are activated (e.g. the pre-entry climate control).

① The vehicle is equipped with an electrical fuse, which protects it against overvoltage in the mains supply. This electrical fuse may trip during severe thunderstorms, for example, and may cause the fuse in the building to trip or may interrupt the charging process. These functions protect the vehicle.

After the fuse in the building is switched on again, the charging process resumes automatically. Following an interruption in the power supply without the fuse in the building being tripped, it may take up to ten minutes for charging to resume automatically.

Ending the alternating current charging process (mode 2/3)

Requirements

- The distance between the key and the vehicle does not exceed 3 ft (1 m).

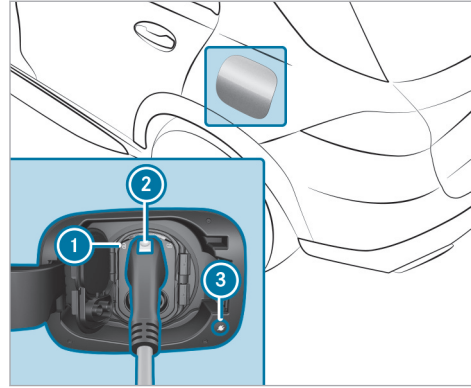

- ▶ Press charging interruption button ③.

or

- ▶ Unlock the vehicle. The charging process is ended. The  indicator lamp ① lights up white. The vehicle socket is unlocked.

- ① Vehicles equipped with a type 1 vehicle socket for AC charging have no charging interruption button ③.

- ▶ **Combo 1 vehicle socket:** press charging interruption button ③.



The charging process is ended. The  indicator lamp ① lights up white. The vehicle socket is unlocked.

- ▶ **Type 1 vehicle socket:** unlock the vehicle. The charging process is ended. The  indicator lamp ① lights up white. The vehicle socket is unlocked.

- ▶ Press and hold button ② on the charging cable connector and remove the charging cable connector from the vehicle socket.

- ① If you cannot remove the charging cable connector, repeat the unlocking procedure. If the charging cable connector is still locked, contact a qualified specialist workshop.

- ▶ Close the socket cover and the socket flap.

- ① After the charging cable connector has been disconnected, the  indicator lamp  on the vehicle socket remains lit for some time before switching off.

Starting the direct-current charging process (mode 4)

⚠ DANGER Risk of death when charging at a damaged socket

The charging process uses high voltage.

If the charging cable, the vehicle socket or the mains socket are damaged, you could receive an electric shock.

- ▶ Only use an undamaged charging cable.
- ▶ Avoid mechanical damage such as crushing, abrading or driving over the cable.
- ▶ Have a damaged vehicle socket replaced at a qualified specialist workshop as soon as possible.
- ▶ Never connect the charging cable to a damaged vehicle socket.

! **NOTE** Damage due to overheating of charging cable and charge port

During the charging process, the charging cable and charge port can heat up within the permissible limits.

The permissible limit values are influenced by the following factors:

- the power supply system and the charging cable are not damaged
- the instructions for handling the charging cable and the control element on the charging cable have been observed

▶ If the charging cable or charge port becomes too hot, have the power supply system checked.

! **NOTE** Damaged or dirty vehicle socket when the socket flap is open

▶ Always keep the socket cover and the socket flap closed when there is no charging cable connected. This protects the vehicle socket from dirt and damage.

▶ Make sure that the socket cover is closed properly before closing the socket flap. This can otherwise result in damage which may prevent the socket flap from being opened again.

! **NOTE** Damage to the vehicle socket or the charging cable connector due to incorrect handling

Do not use excessive force (maximum 67.4 lbf (300 N)) to insert the charging cable connector into the vehicle socket as far as it will go. You may otherwise damage the vehicle socket, the charging cable connector or their contacts.

▶ If you feel there is increased resistance, pull the charging cable connector out of the socket and reinsert it.

Requirements

- The transmission is in position .
- The vehicle is unlocked or the distance between the key and the vehicle is no greater than 3 ft (1 m).

- The vehicle is not switched on. The **READY** indicator on the driver's display is off.
- The charging cable is not taut.

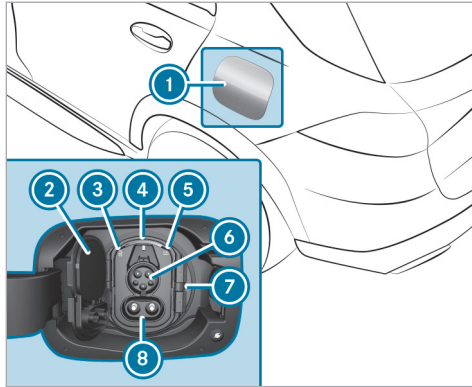

- ▶ Press the center rear section of socket flap **1** and swing the socket flap forwards and open. The **READY** indicator lamp **3** and upper status display **4** will light up white.

- ⓘ When the vehicle is switched on (the **READY** indicator is lit up on the instrument display), socket flap **1** cannot be opened. If socket flap **1** cannot be opened despite the vehicle being unlocked, the charge socket flap can be opened by emergency release (→ page 218).

- ▶ Push catch **7** to the right and fold open socket cover **2**.
- ⓘ The CCS charging cable connector requires connections **6** and **8**. Therefore, it is necessary to open both parts of socket cover **2**.
- ▶ Insert the CCS charging cable connector into the vehicle socket as far as it will go. Make sure that the charging cable is not taut when inserted. The **READY** indicator lamp **5** and status display **4** will flash orange and, as soon as the high-voltage battery is charged, green.

When the charging cable is connected to the vehicle, the vehicle cannot be started or moved.

At the start of the charging process, the charge level display will be shown on the driver's display

with a charging prediction. The charging prediction refers to the time at which the high-voltage battery will be fully charged.

- ⓘ Depending on the temperature, the fan and battery cooling system may audibly switch on during the charging process.
- ⓘ If the vehicle is idle for lengthy periods and connected to the mains supply, the high-voltage battery will be recharged automatically as needed or when electrical consumers are activated (e.g. the pre-entry climate control).

Ending the direct current charging process (mode 4)

Requirements

- The distance between the key and the vehicle does not exceed 3 ft (1 m).

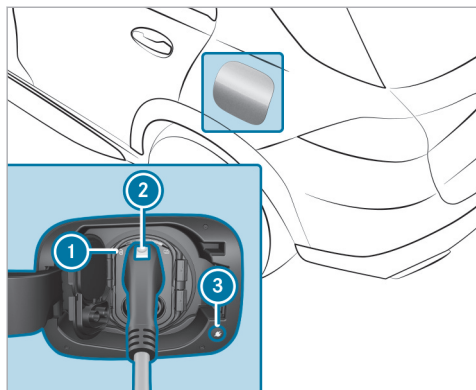

- ▶ Press charging interruption button ③. The charging process is ended. The indicator lamp ① lights up white. The vehicle socket is unlocked.
- ▶ Press and hold button ② on the charging cable connector and remove the charging cable connector from the vehicle socket.

- ⓘ If you cannot remove the charging cable connector, unlock the vehicle and repeat the procedure. If the charging cable connector is still locked, contact a qualified specialist workshop.
- ▶ Close the socket cover and the socket flap.
- ⓘ After the charging cable connector has been disconnected, the left indicator lamp ① on the vehicle socket remains lit for some time before switching off.

Emergency release of the socket flap

If the socket flap cannot be opened due to a malfunction, an emergency release of the socket flap can be performed for the charging process.

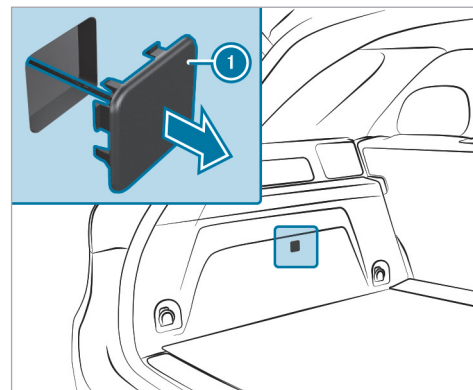

- ▶ Remove cover ① of the emergency release from the cargo compartment trim on the side.
- ▶ Pull the emergency release by cover ① in the direction of the arrow. The socket flap of the vehicle socket swings open.
- ▶ Insert cover ① back into the cargo compartment trim.

▶ Start the alternating current charging process (→ page 212).

or

▶ Start the direct current charging process (→ page 216).

Function of the charge level display on the instrument display

When the vehicle is connected to the mains supply and is switched off, the instrument display shows the charge level display for approximately two minutes.

Parking

Parking the vehicle

⚠ WARNING Risk of accident and injury caused by an insufficiently secured vehicle rolling away

If the vehicle is not securely parked sufficiently, it can roll away in an uncontrolled way even at a slight downhill gradient.

▶ On uphill or downhill gradients, turn the front wheels so that the vehicle rolls towards the curb if it starts moving.

▶ Apply the parking brake.

▶ Switch the transmission to position **P**.

⚠ WARNING Risk of fire caused by hot exhaust system parts

Flammable materials such as leaves, grass or twigs may ignite.

▶ Park the vehicle so that no flammable material can come into contact with hot vehicle components.

▶ In particular, do not park on dry grass-land or harvested grain fields.

⚠ WARNING Risk of accident and injury due to children left unattended in the vehicle

If you leave children unattended in the vehicle, they could, in particular:

- open doors, thereby endangering other persons or road users.
- get out and be struck by oncoming traffic.
- operate vehicle equipment and become trapped, for example.

In addition, the children could also set the vehicle in motion by, for example:

- releasing the parking brake.
- changing the gearbox position.
- starting the vehicle.

▶ Never leave children unattended in the vehicle.

▶ When leaving the vehicle, always take the key with you and lock the vehicle.

▶ Keep the key out of reach of children.

! **NOTE** Damage to the vehicle due to it rolling away

- ▶ Always secure the vehicle against rolling away.

! **NOTE** Damage due to the vehicle lowering

Vehicles with AIRMATIC or E-ACTIVE BODY CONTROL: The vehicle can lower because of temperature differences or longer non-operational times. This can cause damage to parts of the body.

- ▶ When stopping the vehicle and when driving off, make sure that there are no obstacles such as curbs under or in the immediate vicinity of the body.

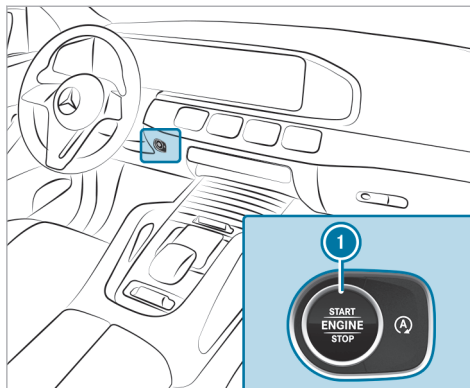

- ▶ Bring the vehicle to a standstill by depressing the brake pedal.
- ▶ On uphill or downhill gradients, turn the front wheels so that the vehicle rolls towards the curb if it starts moving.
- ▶ Apply the electric parking brake.

- ▶ Engage transmission position **P** in a stationary vehicle with the brake pedal depressed (→ page 197).

- ▶ Switch off the vehicle by pressing button **1**.
- ▶ Release the service brake slowly.
- ▶ Get out of the vehicle and lock it.

i When you park the vehicle, you can still operate the side windows and the sliding sunroof for approximately four minutes if the driver's door is closed.

i When you park the vehicle, you can still operate the side windows and the panoramic sliding sunroof for approximately four minutes if the driver's door is closed.

Automatic vehicle shut-off when locking

Your vehicle is equipped with automatic engine shut-off.

When you leave the vehicle ready to drive, the vehicle will be turned off when locked under the following conditions:

- The ignition is switched on or the engine is running.

- Transmission position **P** is engaged.
 - The driver's door is closed.
 - **In addition, one of the following conditions must be fulfilled:**
 - The vehicle is locked using the vehicle key.
 - **Vehicles with KEYLESS-GO:** the vehicle is locked via the locking button in the tail-gate.
- i** The engine will continue to run if the vehicle is not locked as described after it has been left. In this case, switch off the vehicle manually.

Automatic switch-off of the vehicle after a certain period of time (depending on equipment)

When the engine is running, the following display message appears in the driver's display when leaving the vehicle or after a certain time stopped in transmission position **P** : [Vehicle Ready to Drive Shutdown Occurs When Locked or Automatically in XX Mins](#)

The vehicle is then automatically switched off after a total of 20 minutes of time stopped.

- i** To avoid automatic switch-off after the time has elapsed, confirm the corresponding message in the central display of the multimedia system.

In the following cases, the engine continues to run:

- if the vehicle is not locked as described after leaving it
- if the automatic switch-off is not displayed by the display message
- if, once the time has elapsed, the automatic switch-off has been deactivated via the corresponding message in the central display

In this case, switch off the vehicle manually.

Garage door opener

■ Programming buttons for the garage door opener

⚠ DANGER Risk of death caused by exhaust gases

Combustion engines emit poisonous exhaust gases such as carbon monoxide. Inhaling these exhaust gases is hazardous to health and leads to poisoning.

- ▶ Never leave the engine or, if present, the auxiliary heating running in an enclosed space without sufficient ventilation.

⚠ WARNING Risk of injury by becoming trapped when opening and closing a garage door

When you operate or program a garage door with an integrated garage door opener, persons can become trapped or struck by the garage door if they stand within its range of movement.

- ▶ Always make sure that nobody is within the range of the garage door's movement.

Only operate the following doors using the garage door opener:

- Doors with a safety stop and reversing feature
- Doors which conform to the current U.S. safety standards

Before programming the garage door opener, park the vehicle outside the garage. Make sure that the vehicle is switched on but not started.

Requirements

- The vehicle has been parked outside the garage or outside the range of movement of the door.
- The vehicle is switched on.
- The vehicle has not been started.

- ⓘ The garage door opener function is always available when the vehicle is switched on.

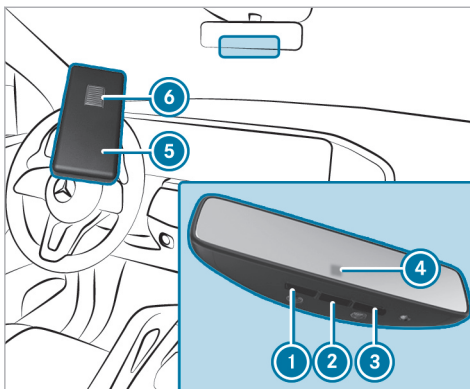

- ▶ Check if the transmitter frequency of the remote control has the frequency range of 280 to 868 MHz.

Radio equipment approval number:

- NZLMUAHL5 (USA)
- 4112A-MUAHL5 (Canada)

- ▶ Press and hold button ①, ② or ③ that you wish to program. Indicator lamp ④ flashes yellow.

- ⓘ It can take up to 20 seconds before the indicator lamp flashes yellow.

- ▶ Release the previously pressed button. Indicator lamp ④ continues to flash yellow.

- ▶ Point remote control ⑤ from a distance of 0.4 in (1 cm) to 3 in (8 cm) towards button ①, ② or ③.

- ▶ Press and hold button ⑥ of remote control ⑤ until one of the following signals appears:

- Indicator lamp ④ lights up green continuously. Programming is complete.
- Indicator lamp ④ flashes green. Programming was successful. Additionally, synchronization of the rolling code with the door system must be carried out.

- ▶ If indicator lamp ④ does not light up or flash green: repeat the procedure.

- ▶ Release all of the buttons.

- i** The remote control for the door drive is not included in the scope of delivery of the garage door opener.

■ Synchronizing the rolling code

Requirements

- The door system uses a rolling code.
- The vehicle must be within range of the garage door or door drive.
- The vehicle as well as persons and objects are located outside the range of movement of the door.

▶ Press the program button on the door drive unit. Initiate the next step within approximately 30 seconds.

▶ Press previously programmed button **1**, **2** or **3** repeatedly until the door closes. When the door closes, programming is completed.

- i** Please also read the operating instructions for the door drive.

■ Troubleshooting when programming the remote control

- ▶ Check if the transmitter frequency of remote control **5** is supported.
- ▶ Replace the batteries in remote control **5**.
- ▶ Hold remote control **5** at various angles from a distance of 0.4 in (1 cm) to 3 in (8 cm) front of the inside rearview mirror. You should test every position for at least 25 seconds before trying another position.
- ▶ Hold remote control **5** at the same angles at various distances in front of the inside rear view mirror. You should test every position for at least 25 seconds before trying another position.
- ▶ On remote controls that transmit only for a limited period, press button **6** on remote control **5** again before transmission ends.
- ▶ Angle the antenna line of the garage door opener unit towards the remote control.

- i** It is possible that older garage doors cannot be operated using the remote control in the inside rearview mirror even after you have

successfully performed the measures described above. If this is the case, contact the HomeLink® Hotline.

- i** Support and additional information on programming:

- on the toll free HomeLink® Hotline on 1-800-355-3515
- on the Internet at <https://www.homelink.com/mercedes>

■ Opening or closing the garage door

Requirements

- The corresponding button is programmed to operate the door.
- ▶ Press and hold buttons **1**, **2** or **3** until the door opens or closes.
- ▶ If the indicator lamp **4** flashes yellow after approx. 20 seconds: Press the previously pressed button again and keep it pressed until the door opens or closes.

Clearing the garage door opener memory

- ▶ Press and hold buttons ❶ and ❸.
Indicator lamp ❹ lights up yellow.
- ▶ If indicator lamp ❹ flashes green: release buttons ❶ and ❸.
The entire memory has been deleted.

Electric parking brake

Function of the electric parking brake (applying automatically)

⚠ WARNING Risk of accident and injury due to children left unattended in the vehicle

If you leave children unattended in the vehicle, they could, in particular:

- open doors, thereby endangering other persons or road users.
- get out and be struck by oncoming traffic.
- operate vehicle equipment and become trapped, for example.

In addition, the children could also set the vehicle in motion by, for example:

- releasing the parking brake.
- changing the gearbox position.
- starting the vehicle.

- ▶ Never leave children unattended in the vehicle.
- ▶ When leaving the vehicle, always take the key with you and lock the vehicle.
- ▶ Keep the key out of reach of children.

The electric parking brake is applied if the transmission is in position **P and one of the following conditions is fulfilled:**

- The vehicle is switched off.
- The seat belt tongue is not inserted in the seat belt buckle of the driver's seat and the driver's door is opened.

❶ To prevent application: pull the handle of the electric parking brake (→ page 225).

In the following situations, the electric parking brake is also applied:

- The HOLD function is keeping the vehicle stationary.
- Active Parking Assist is keeping the vehicle stationary.
- Active Distance Assist DISTRONIC is bringing the vehicle to a standstill.
- **In addition, one of the following conditions must be fulfilled:**
 - The vehicle is switched off.
 - The seat belt tongue is not inserted in the seat belt buckle of the driver's seat and the driver's door is opened.
 - There is a system malfunction.
 - The power supply is insufficient.
 - The vehicle is stationary for a lengthy period.

When the electric parking brake is applied, the red **PARK** (USA) or **(P)** (Canada) indicator lamp lights up in the driver's display.

- ❗ The electric parking brake is not automatically applied if the vehicle is switched off by the ECO start/stop function.

Function of the electric parking brake (releasing automatically)

The electric parking brake is released when the following conditions are fulfilled:

- The driver's door is closed.
- The vehicle has been started.
- The transmission is in position **D** or **R** and you depress the accelerator pedal or you shift from transmission position **P** to **D** or **R** when on level ground.
- If the transmission is in position **R**, the tailgate must be closed.
- The seat belt tongue is inserted into the seat belt buckle of the driver's seat.

If the seat belt tongue is not inserted into the seat belt buckle of the driver's seat, one of the following conditions must be fulfilled:

- You shift from transmission position **P**.
- or

- You have previously driven at speeds greater than 2 mph (3 km/h).

When the electric parking brake is released, the red **PARK** (USA) or **(P)** (Canada) indicator lamp in the driver's display goes out.

Applying/releasing the electric parking brake manually

Applying

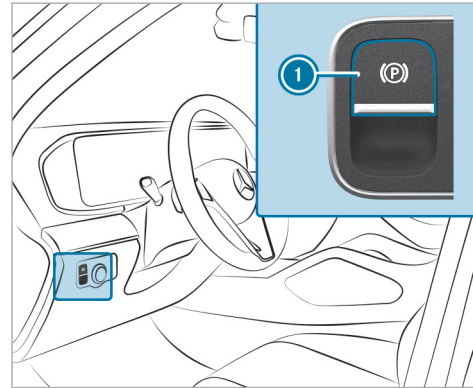

- ▶ Push handle **1**.
The red **PARK** (USA) or **(P)** (Canada) indicator lamp lights up in the driver's display.

- ❗ The electric parking brake is only securely applied if the red **PARK** (USA) or **(P)** (Canada) indicator lamp is lit continuously.

Releasing

- ▶ Switch on the vehicle.
- ▶ Pull handle **1**.
The red **PARK** (USA) or **(P)** (Canada) indicator lamp in the driver's display goes out.

Emergency braking

- ▶ Press and hold handle **1**.
As long as the vehicle is in motion, the **Release Parking Brake** message is displayed and the red **PARK** (USA) or **(P)** (Canada) indicator lamp flashes.

When the vehicle has been braked to a standstill, the electric parking brake is applied. The red **PARK** (USA) or **(P)** (Canada) indicator lamp lights up in the driver's display.

Information on collision detection on a parked vehicle

If a collision is detected on the locked vehicle when the tow-away alarm is activated and collision detection is switched on, you will receive a message in the multimedia system when the vehicle is switched on.

You will receive information about the following points:

- The area of the vehicle that may have been damaged.
- The force of the impact.

The following situation can lead to inadvertent activation:

- The parked vehicle is moved, for example, in a two-story garage.

- ① Deactivate the tow-away alarm in order to prevent inadvertent activation. If you deactivate the tow-away alarm, collision detection will also be deactivated.

You can permanently deactivate collision detection via the multimedia system (→ page 226).

- ① If the battery is severely discharged, the function for detecting a collision on a parked vehicle is automatically deactivated to facilitate the next engine start.

System limits

Detection may be restricted in the following situations:

- the vehicle is damaged without impact, for example, if an outside mirror is torn off or the paint is damaged by a key
 - an impact occurs at low speed
 - the electric parking brake is not applied
- ① You are responsible for your vehicle. Convince yourself that your vehicle is free of damage and roadworthy.

Setting collision detection on a parked vehicle

Multimedia system:

→  » Settings » Vehicle

» Open/Close » Vehicle Protection

- ▶ Activate or deactivate the function via [Collision Notification](#).

- ① A maximum of three incidents can be registered. Up to 15 photos are taken for every incident. In the event of another incident, the photos of the first incident will be overwritten if they have not been deleted already.

Activating or deactivating the collision photos function

Note possible legal restrictions in some countries regarding automatic recording of the vehicle surroundings.

- ▶ Activate or deactivate [Collision Photos](#).

Transferring the collision photos with the Mercedes me App

- ▶ Select [Upload Collision Photos](#).
- ▶ Select [Upload Automatically](#).

- ▶ Scan the generated QR code on the media display with the Mercedes me app. The encrypted collision photos will then be uploaded to Mercedes me.

ⓘ Any device that can scan QR codes can be used to view the collision photos in the Mercedes me App.

Copying the collision photos to a USB flash drive

- ▶ Connect a USB flash drive .

- ▶ Select **Manage Collision Photos**.

- ▶ Select **Copy (USB)**.

All collision photos are copied to the USB flash drive.

ⓘ To ensure secure operation, only use with FAT32 or exFAT formatted USB storage devices.

Deleting collision photos

- ▶ Select **Manage Collision Photos**.

- ▶ Select **Delete**.

All collision photos will be deleted.

Notes on parking the vehicle for an extended period

If you leave the vehicle parked for longer than six weeks, it may suffer damage through disuse.

The 12 V battery may also be impaired or damaged by heavy discharging.

ⓘ Further information can be obtained at a qualified specialist workshop.

Standby mode (extension of the starter battery's period out of use)

■ Standby mode function

ⓘ This function is not available for all models.

If standby mode is activated, energy loss will be minimized during extended periods of non-operation.

Standby mode is characterized by the following:

- The starter battery is preserved.
- The maximum non-operational time appears on the central display.
- The connection to online services is interrupted.

- The ATA (anti-theft alarm system) is not available.
- The interior protection and tow-away alarm functions are not available.
- The function for detecting collisions for a parked vehicle is not available.

If the following conditions are fulfilled, standby mode can be activated or deactivated using the multimedia system:

- The vehicle is switched on.
- The vehicle has not been started.

Exceeding the vehicle's displayed non-operational time may cause inconvenience; i.e. it cannot be guaranteed that the starter battery will reliably start the vehicle.

Charge the starter battery in the following situations:

- The vehicle's non-operational time must be extended.
- The state of charge of the starter battery is insufficient for standby mode.

- ① Standby mode is automatically deactivated when the vehicle is switched on.

■ Activating/deactivating standby mode (parking up the vehicle)

Requirements

- The power supply is switched on.
- The vehicle is not switched on.

Multimedia system:

-  → Settings → Vehicle
- Other Functions
- ▶ Activate or deactivate **Standby Mode**.

Driving and driving safety systems

Driving systems and your responsibility

Your vehicle is equipped with driving systems that assist you in driving, parking and maneuvering the vehicle. The driving systems are only aids. They are not a substitute for you paying attention to your surroundings and do not relieve you of your responsibility pertaining to road traffic law. The driver is always responsible for maintaining a safe

distance to the vehicle in front, for vehicle speed, for braking in good time and for staying in lane. Pay attention to the traffic conditions at all times and intervene when necessary. Be aware of the limitations regarding the safe use of these systems.

Driving systems can neither reduce the risk of an accident if you fail to adapt your driving style nor override the laws of physics. They cannot always take into account road, weather or traffic conditions.

- ① Some driving systems can regulate or limit the speed to a previously set value. Draw attention to the stored speed when changing drivers.

Information on vehicle sensors and cameras

Some driving and driving safety systems use cameras as well as radar or ultrasonic sensors to monitor the area in front of, behind or next to the vehicle.

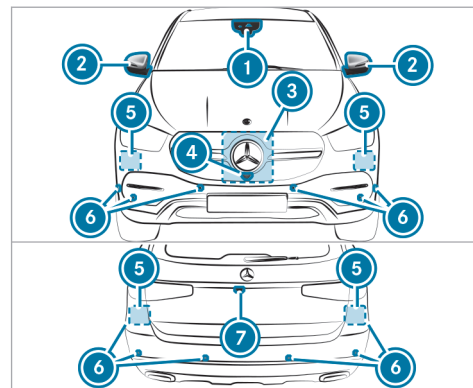

- ① Multifunction camera
- ② Cameras in the outside mirrors
- ③ Front radar
- ④ Front camera
- ⑤ Corner radars
- ⑥ Ultrasonic sensors
- ⑦ Rear-view camera

▲ WARNING Risk of accident due to restricted detection performance of vehicle sensors and cameras

If the area around vehicle sensors or cameras is covered, damaged or dirty, certain driving and safety systems cannot function correctly. There is a risk of an accident.

- ▶ Keep the area around vehicle sensors or cameras clear of any obstructions and clean.
- ▶ Have damage to the bumper, radiator grille or stone chipping in the area of the front and rear windows repaired at a qualified specialist workshop.

Keep the areas around the sensors and cameras in particular free of dirt, ice and slush (→ page 383). The sensors and cameras must not be covered and the detection areas around them must be kept clear. Do not attach additional license plate bracket, advertisements, stickers, wraps or stone chip protection films in the detection range of the sensors and cameras. Make sure

that there are no overhanging loads protruding into the detection area.

If there is damage to a bumper or the radiator grille, or after an impact, have the function of the sensors checked at a qualified specialist workshop. Have damage or stone chipping around the cameras on the front and rear passenger compartment windows repaired at a qualified specialist workshop.

Overview of driving systems and driving safety systems

- ABS (→ page 230)
- Off-road ABS (→ page 230)
- BAS (→ page 230)
- ESP® (→ page 231)
- ESP® Crosswind Assist (→ page 232)
- ESP® trailer stabilization (→ page 232)
- EBD (→ page 234)
- STEER CONTROL (→ page 234)
- HOLD function (→ page 234)

- Hill Start Assist (→ page 235)
- ATTENTION ASSIST (→ page 235)
- Cruise control (→ page 237)
- Traffic Sign Assist (→ page 258)
- AIRMATIC (→ page 266)
- E-ACTIVE BODY CONTROL (→ page 272)
- Trailer Maneuvering Assist (→ page 298)

Driving Assistance Package

The following functions are part of the Driving Assistance Package. Certain functions are only available in some countries. Some functions are also available without the Driving Assistance Package, albeit with restricted functionality.

- Active Distance Assist DISTRONIC (→ page 239)
- Active Speed Limit Assist (country-dependent) (→ page 243)
- Route-based speed adaptation (country-dependent) (→ page 244)
- DSR (→ page 246)
- Active Brake Assist (→ page 253)

- Active Steering Assist (country-dependent) (→ page 248)
- Active Emergency Stop Assist (country-dependent) (→ page 250)
- Active Lane Change Assist (country-dependent) (→ page 251)
- Active Stop-and-Go Assist (country-dependent) (→ page 246)
- Blind Spot Assist and Active Blind Spot Assist with exit warning (→ page 260)
- Active Lane Keeping Assist (→ page 263)

Parking Package

- Rear view camera (→ page 280)
- 360° camera (→ page 281)
- Parking Assist PARKTRONIC (→ page 287)
- Active Parking Assist (→ page 291)

Function of ABS

The Anti-lock Brake System (ABS) regulates the brake pressure in critical driving situations:



- During braking, for instance, at maximum full-stop braking or if there is insufficient tire traction, the wheels are prevented from locking.
- Vehicle steerability while braking is ensured.

If ABS intervenes when braking, you will feel a pulsing in the brake pedal. The pulsating brake pedal can be an indication of hazardous road conditions and can serve as a reminder to take extra care while driving.

System limits

- ABS is active from speeds of approx. 3 mph (5 km/h).
- ABS may be impaired or may not function if a malfunction has occurred and the yellow  ABS warning lamp lights up continuously after the vehicle is started.

Function of off-road ABS

 Off-road ABS is activated automatically when you select the  drive program.

Off-road ABS is specially adapted for driving off-road:

- The front wheels lock cyclically during braking.
- The braking distance is shortened due to the digging-in effect.

System limits

- Off-road ABS functions at speeds below 25 mph (40 km/h).
- If Off-road ABS intervenes, the ability to steer may be restricted.

Function of BAS

 **WARNING** Risk of an accident caused by a malfunction in BAS (Brake Assist System)

If BAS is malfunctioning, the braking distance in an emergency braking situation is increased.

- ▶ Depress the brake pedal with full force in emergency braking situations. ABS prevents the wheels from locking.

The Brake Assist System (BAS) supports your emergency braking situation with additional brake force.

If you depress the brake pedal quickly, BAS is activated:

- BAS automatically boosts the brake pressure.
- BAS can shorten the braking distance.
- ABS prevents the wheels from locking.

The brakes will function as usual once you release the brake pedal. BAS is deactivated.

Function of ESP®

⚠ WARNING Risk of skidding if ESP® is deactivated

If you deactivate ESP®, ESP® cannot carry out vehicle stabilization.

- ▶ ESP® should only be deactivated in the following situations.

! NOTE Mercedes-AMG vehicles

- ▶ Observe the notes in the Supplement. You could otherwise fail to recognize dangers.

The Electronic Stability Program (ESP®) can monitor and improve driving stability and traction in the following situations within physical limits:

- When pulling away on wet or slippery roads.
- When braking.

If the vehicle deviates from the direction desired by the driver, ESP® can stabilize the vehicle by intervening in the following ways:

- One or more wheels are braked.
- The engine output is adapted according to the situation.

When ESP® is deactivated, the  warning lamp lights up continuously:

- Driving stability will no longer be improved.
- The drive wheels could spin.
- ETS/4ETS traction control is still active.

i When ESP® is deactivated, you are still assisted by ESP® when braking.

When the  warning lamp flashes, one or several wheels has reached its grip limit:

- Adapt your driving style to suit the current road and weather conditions.
- Do not deactivate ESP®.
- Only depress the accelerator pedal as far as is necessary when pulling away.

Deactivate ESP® in the following situations to improve traction:

- When using snow chains.
- In deep snow.
- On sand or gravel.

 Spinning the wheels results in a cutting action, which enhances traction.

If the  warning lamp lights up continuously, ESP® is not available due to a malfunction.

Observe the following information:

- Warning and indicator lamps (→ page 536)
- Display messages (→ page 468)

ETS/4ETS (Electronic Traction System)

ETS/4ETS traction control is part of ESP® and makes it possible to pull away and accelerate on a slippery road.

If you select the  drive program, a special ETS system specifically suited to off-road terrain is automatically activated.

ETS/4ETS can improve the vehicle's traction by intervening in the following ways:

- The drive wheels are braked individually if they spin.
- More drive torque is transferred to the wheel or wheels with traction.

Influence of drive programs on ESP®

The drive programs enable ESP® to adapt to different weather and road conditions as well as the driver's preferred driving style. Depending on the selected drive program, the appropriate ESP® mode will be activated (→ page 194).

Function of ESP® Crosswind Assist

ESP® Crosswind Assist detects sudden gusts of side wind and helps the driver to keep the vehicle in the lane:

- ESP® Crosswind Assist is active at vehicle speeds between approx. 50 mph (80 km/h) and 125 mph (200 km/h) when driving straight ahead or cornering slightly.
- The vehicle is stabilized by means of individual brake application on one side.

Function of ESP® trailer stabilization

 **WARNING** Risk of accident in poor road and weather conditions

In poor road and weather conditions, the trailer stabilization cannot prevent lurching of the vehicle/trailer combination. Trailers with a high center of gravity may tip over before ESP® detects this.

 Always adapt your driving style to suit the current road and weather conditions.

When you are driving with a trailer, ESP® can stabilize your vehicle if the trailer begins to swerve from side to side:

- ESP® trailer stabilization will be active at speeds above 40 mph (65 km/h).
- Slight swerving is reduced by means of a targeted, individual brake application on one side.
- In the event of severe swerving, the operating energy output will also be reduced and the brakes will be applied to all wheels.

ESP® trailer stabilization may be impaired or may not function if:

- The trailer is not connected correctly or is not detected properly by the vehicle.

Activating/deactivating ESP® (Electronic Stability Program)

Multimedia system:



- ⓘ ESP® can only be activated/deactivated using quick access when at least one other function is available in quick access. ESP® can otherwise be found in the [Assistance](#) menu.

! NOTE Mercedes-AMG vehicles

- ▶ Observe the notes in the Supplement. You could otherwise fail to recognize dangers.

- ▶ Select [ESP](#).
- ▶ Select [On](#) or [Off](#).

ESP® is deactivated if the ESP® OFF warning lamp  lights up continuously on the driver's display.

Observe any information on warning lamps and display messages which may be shown on the driver's display.

Activating/deactivating ESP® (with Off-Road package or E-Active Body Control)

! NOTE Mercedes-AMG vehicles

- ▶ Observe the notes in the Supplement. You could otherwise fail to recognize dangers.

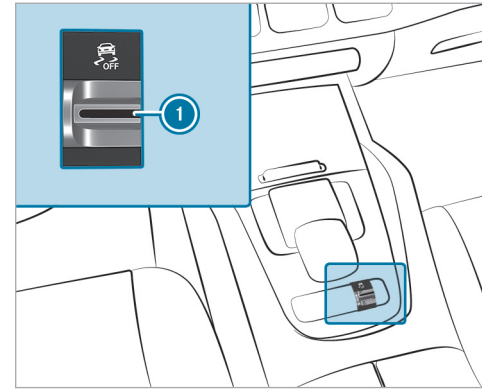

- ▶ Pull rocker switch .

ESP® is deactivated if the  ESP® OFF warning lamp lights up continuously on the driver's display.

Observe the information on warning lamps and display messages .

Function of EBD

Electronic Brakeforce Distribution (EBD) is characterized by the following:

- Monitoring and regulating the brake pressure on the rear wheels.
- Improved driving stability when braking, especially on bends.

Function of STEER CONTROL

STEER CONTROL assists you by transmitting a noticeable steering force to the steering wheel in the direction required for vehicle stabilization.

This steering recommendation is given in the following situations:

- both right wheels or both left wheels are on a wet or slippery road surface when you brake
- the vehicle starts to skid

System limits

STEER CONTROL may be impaired or may not function in the following situations:

- ESP® is deactivated.

- ESP® is malfunctioning.
- The steering is malfunctioning.

If ESP® is malfunctioning, you will be assisted further by the electric power steering.

HOLD function

HOLD function

The HOLD function holds the vehicle at a standstill without requiring you to depress the brake pedal, e.g. while waiting in traffic.

The HOLD function is only an aid. The responsibility for the vehicle safely standing still remains with the driver.

System limits

The HOLD function is only intended to provide assistance when driving and is not a sufficient means of safeguarding the vehicle against rolling away when stationary.

- The incline must not be greater than 30%.

Activating/deactivating the HOLD function

▲ WARNING Risk of an accident due to the HOLD function being active when you leave the vehicle

If the vehicle is only braked with the HOLD function it could, in the following situations, roll away:

- If there is a malfunction in the system or in the power supply.
- If the HOLD function is deactivated by depressing the accelerator pedal or brake pedal, e.g. by a vehicle occupant.

▶ Always secure the vehicle against rolling away before you leave it.

Requirements

- The vehicle is stationary.
- The driver's door is closed or the seat belt on the driver's side is fastened.
- The vehicle has been started or has been automatically switched off by the ECO start/stop function.

- The electric parking brake is released.
- Active Distance Assist DISTRONIC is deactivated.
- The transmission is in position **D**, **R** or **N**.

Activating the HOLD function

- ▶ Depress the brake pedal, and after a short time quickly depress further until the **HOLD** display appears in the driver's display.
- ▶ Release the brake pedal.

Deactivating the HOLD function

- ▶ Depress the accelerator pedal to pull away, or
- ▶ Depress the brake pedal until the **HOLD** display disappears from the driver's display.

The HOLD function is deactivated in the following situations:

- Active Distance Assist DISTRONIC is activated.
- The transmission is shifted to position **P**.
- The vehicle is secured with the electric parking brake.

In the following situations, the vehicle is held by transmission position **P** and/or by the electric parking brake:

- The seat belt is unfastened and the driver's door is opened.
- The vehicle is switched off.
- There is a system malfunction.
- The power supply is insufficient.

In addition, the **Brake Immediately** message may appear in the driver's display and a horn tone may sound at regular intervals.

- ▶ Immediately depress the brake pedal firmly until the warning message disappears. The HOLD function is deactivated.
- ▶ Additionally secure the vehicle against rolling away.

Function of Hill Start Assist

Hill Start Assist holds the vehicle for a short time when you pull away on a hill under the following conditions:

- The transmission is in position **D** or **R**.

- The electric parking brake is released.

This gives you enough time to move your foot from the brake pedal to the accelerator pedal and depress it before the vehicle begins to roll away.

⚠ WARNING Risk of accident and injury due to the vehicle rolling away

After a short time, Hill Start Assist no longer holds the vehicle.

- ▶ Swiftly move your foot from the brake pedal to the accelerator pedal. Do not leave the vehicle when it is being held by Hill Start Assist.

ATTENTION ASSIST

Function of ATTENTION ASSIST

ATTENTION ASSIST assists you on long, monotonous journeys, e.g. on highways and trunk roads. If indicators of fatigue or increasing lapses in concentration on the part of the driver are detected, the system suggests taking a break.

ATTENTION ASSIST is only an aid. It cannot always detect fatigue or lapses in concentration in

time. The system is not a substitute for a well-rested and attentive driver. On long journeys, take regular breaks in good time that allow for adequate recuperation.

You can choose between two settings:

- **Standard:** normal system sensitivity.
- **Sensitive:** higher system sensitivity. The driver is warned earlier and the attention level detected by ATTENTION ASSIST is adapted accordingly.

If drowsiness or increasing lapses in concentration are detected, the **ATTENTION ASSIST: Take a Break!** warning appears in the driver's display. You can acknowledge the message and take a break where necessary. If you do not take a break and ATTENTION ASSIST continues to detect increasing lapses in concentration, you will be warned again after a minimum of 15 minutes.



The following information is displayed in the driver's display:

- The length of the journey since the last break
- The attention level determined by ATTENTION ASSIST.

The more segments ① of the circle displayed, the higher the detected attention level. Fewer segments ① are displayed in the circle as the attention level decreases.

If ATTENTION ASSIST is unable to calculate the attention level and cannot issue a warning, the **System Suspended** message appears.

If a warning is given in the driver's display, the multimedia system offers to search for a rest area. You can select a rest area and start navigation to this rest area.

When you restart the vehicle, ATTENTION ASSIST is automatically switched on. The last selected sensitivity level remains stored.

System limits

ATTENTION ASSIST is active in the 37 mph (60 km/h) to 124 mph (200 km/h) speed range.

If the system is not available due to an error, the ATTENTION ASSIST warning light is permanently lit  in the driver display

Particularly in the following situations, ATTENTION ASSIST only functions in a restricted manner and warnings may be delayed or not occur:

- If you have been driving for less than approximately 30 minutes.
- If the road condition is poor (uneven road surface or potholes).
- If there is a strong side wind.
- If you adopt a sporty driving style (high cornering speeds or high rates of acceleration).

- If the Steering Assist function of Active Distance Assist DISTRONIC is active.
- If the clock is set to the incorrect time.
- If you change lanes and vary your speed frequently in active driving situations.

Also observe any information regarding display messages that can be displayed in the driver's display.

The ATTENTION ASSIST drowsiness or alertness assessment is reset and restarted when continuing the journey in the following situations:

- You switch off the vehicle.
- If you unfasten your seat belt and open the driver's door (e.g. to change drivers or take a break).

Setting ATTENTION ASSIST

Multimedia system:

→  ► Settings ► Assistance
► Assistance ► ATTENTION ASSIST

Setting the sensitivity

► Select  next to ATTENTION ASSIST.

► Select **Standard** or **Sensitive**.

Speed control cruise control

Function of cruise control

Cruise control regulates the speed to the value selected by the driver.

If you accelerate to overtake, for example, the stored speed is not deleted. If you remove your foot from the accelerator pedal after overtaking, cruise control will resume speed regulation back to the stored speed.

You can store any speed above 15 mph (20 km/h) up to the maximum design speed.

Observe the notes on driving systems and your responsibility; you may otherwise fail to detect dangers (→ page 228).

Mercedes-AMG vehicles: cruise control is available up to a maximum speed of 155 mph (250 km/h).

Displays in the driver's display

-  (green): cruise control is selected but not yet active, or temporarily passive.

-  (green): cruise control is active.

A stored speed appears under the  display and is indicated in the speedometer.

System limits

Cruise control may be unable to maintain the stored speed on uphill gradients. The stored speed is resumed when the gradient evens out.

Change into a lower gear in good time on long and steep downhill gradients. Take particular note of this when driving a laden vehicle. By doing so, you will make use of the braking effect of the engine. This relieves the load on the brake system and prevents the brakes from overheating and wearing too quickly.

Do not use cruise control in the following situations:

- in traffic situations which require frequent changes of speed, e.g. in heavy traffic, on winding roads
- on slippery roads. Accelerating can cause the drive wheels to lose traction and the vehicle could then skid.
- when visibility is poor

Operating cruise control

⚠ WARNING Risk of accident due to stored speed

If you call up the stored speed and this is lower than your current speed, the vehicle decelerates.

- ▶ Take into account the traffic situation before calling up the stored speed.

Requirements

- Cruise control is selected.
- ESP® must be activated, but not intervening.
- The vehicle speed is at least 15 mph (20 km/h).
- The transmission is in position **D**.

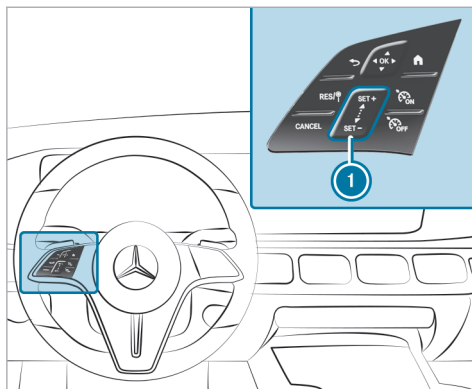

Steering wheel control panel for cruise control

RES/+ Adopts the stored/detected speed

CANCEL Deactivates cruise control

ON Activates cruise control

OFF Deactivates cruise control

1 Control panel to increase/reduce speed

Switching cruise control on

- ▶ Press **ON**.

Activating cruise control

- ▶ Press **SET+** or **SET-** on control panel **1**.
The current speed is stored and maintained by the vehicle.

or

- ▶ Press **RES/+**.
The last stored speed is called up and maintained by the vehicle.
If the last stored speed has previously been deleted, the current vehicle speed is stored.

i When you switch off the vehicle, the last speed stored is deleted.

Increasing/reducing the stored speed

- ▶ To increase the stored speed: swipe upwards from the bottom of control panel **1**.
 - The stored speed is increased by 1 mph (1 km/h).
- ▶ To reduce the stored speed: swipe downwards from the top of control panel **1**.
 - The stored speed is reduced by 1 mph (1 km/h).

or

- ▶ Briefly press **SET+** or **SET-** on control panel **1**.

The stored speed is increased or reduced to the following values depending on the unit:

- **mph:** the next value ending in 5
- **km/h:** the next value ending in 0

or

- ▶ Accelerate the vehicle to the desired speed.
- ▶ Press **SET+** on control panel **1**.

Adopting a detected speed

If cruise control is activated and Traffic Sign Assist has detected a traffic sign with a maximum permissible speed and this is displayed on the driver's display:

- ▶ Press **RES/Ⓢ**.
The maximum permissible speed shown by the traffic sign is stored and the vehicle maintains this speed.

Deactivating cruise control

- ▶ Press **CANCEL**.

Switching cruise control off

- ▶ Press **ESP OFF**.

- i** If you brake, deactivate ESP® or if ESP® intervenes, cruise control is deactivated.

Active Distance Assist DISTRONIC

Function of Active Distance Assist DISTRONIC

Active Distance Assist DISTRONIC maintains the set speed when you are driving freely. If vehicles are detected ahead, the set distance is maintained, if necessary until the vehicle comes to a standstill. The vehicle accelerates or brakes depending on the distance to the vehicle in front and the set speed. The speed and distance to the vehicle in front are set and saved using the steering wheel.

Available speed range:

- **Vehicles without Driving Assistance Package:**
15 mph (20 km/h) - 100 mph (160 km/h)
- **Vehicles with Driving Assistance Package:**
15 mph (20 km/h) - 130 mph (210 km/h)

Other features of Active Distance Assist DISTRONIC:

- Adjusts the driving style depending on the selected drive program (fuel-saving, comfortable or dynamic)
- Initiates acceleration to the stored speed if the turn signal indicator is switched on to change to the overtaking lane
- **Vehicles with Driving Assistance Package:**
 - Reacts to stationary vehicles detected in urban speed ranges (except bicycles and motorcycles)
 - Takes one-sided overtaking restrictions into account on highways or on multi-lane roads with separate roadways (country-dependent)

Vehicles with Driving Assistance Package and Parking Package: if the vehicle has been braked to a standstill on multi-lane, separate roadways by Active Distance Assist DISTRONIC, it can automatically follow the vehicle in front when driving off again within 30 seconds. If a critical situation is detected when you are driving off, a visual and acoustic warning is given indicating that the driver

must now take control of the vehicle. The vehicle is not accelerated any further.

Observe the notes on driving systems and your responsibility; you may otherwise fail to recognize dangers (→ page 228).

Display on the driver's display in the **Assistance** menu

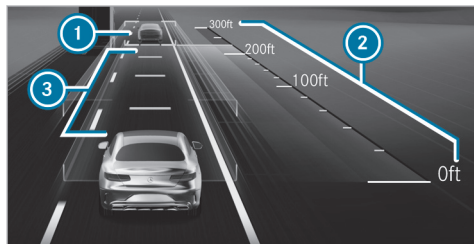

- ① Vehicle in front
- ② Distance indicator
- ③ Set specified distance

Vehicle detected in front ① is highlighted in green. It may also be in the lane to the left of your

vehicle in situations where it is not permitted to overtake on the right, such as on highways.

Permanent status display

- (gray): Active Distance Assist DISTRONIC selected but not yet active
- (green speedometer, gray vehicle): Active Distance Assist DISTRONIC active, speed set
- (green): Active Distance Assist DISTRONIC active and vehicle detected

The stored speed is shown under the permanent status display and highlighted on the speedometer. When Active Distance Assist DISTRONIC is passive, the status display is grayed out.

If the speed of the vehicle in front or the speed adjustment is less than the stored speed due to the route event ahead, the segments in the speedometer light up.

When the set specified distance is increased or reduced, the display briefly appears.

① On highways or high-speed major roads, the green vehicle symbol is displayed cyclically when the vehicle is ready to pull away.

① If you depress the accelerator pedal beyond the setting of the Active Distance Assist DISTRONIC, the system is switched to passive mode. The **Suspended** message appears on the driver's display briefly.

System limits

The system may be impaired or may not function in the following situations, for example:

- In snow, rain, fog, heavy spray, direct sunlight or highly variable light conditions, or if there is glare.
- If there is swirling dust, e.g. when you are driving off-road or on sandy surfaces.
- The windshield in the area of the camera is dirty, fogged up, damaged or covered.
- If the radar sensors are dirty or covered.
- In parking garages or on roads with steep uphill or downhill gradients.
- If there are narrow vehicles in front, such as bicycles or motorcycles.

In addition, on slippery roads, braking or accelerating can cause one or several wheels to lose traction and the vehicle could then skid.

Do not use Active Distance Assist DISTRONIC in these situations.

⚠ WARNING Risk of accident from acceleration or braking by Active Distance Assist DISTRONIC

Active Distance Assist DISTRONIC may accelerate or brake in the following cases, for example:

- If the vehicle pulls away using Active Distance Assist DISTRONIC.
- If the stored speed is called up and is considerably faster or slower than the currently driven speed.
- If Active Distance Assist DISTRONIC no longer detects a vehicle in front or does not react to relevant objects.

▶ Always carefully observe the traffic conditions and be ready to brake at all times.

▶ Take into account the traffic situation before calling up the stored speed.

⚠ WARNING Risk of accident due to insufficient deceleration by Active Distance Assist DISTRONIC

Active Distance Assist DISTRONIC brakes your vehicle with up to 50% of the possible deceleration. If this deceleration is not sufficient, Active Distance Assist DISTRONIC alerts you with a visual and acoustic warning.

- ▶ Adjust your speed and maintain a suitable distance from the vehicle in front.
- ▶ Brake the vehicle yourself and/or take evasive action.

⚠ WARNING Risk of accident if detection function of Active Distance Assist DISTRONIC is impaired

Active Distance Assist DISTRONIC does not react or has a limited reaction:

- when driving on a different lane or when changing lanes
- to pedestrians, animals, bicycles or stationary vehicles, or unexpected obstacles
- to complex traffic conditions
- to oncoming vehicles and crossing traffic

As a result, Active Distance Assist DISTRONIC may neither give warnings nor intervene in such situations.

▶ Always observe the traffic conditions carefully and react accordingly.

■ Operating Active Distance Assist DISTRONIC

Requirements

- The electric parking brake is released.
- ESP® is activated and is not intervening.

- The transmission is in position **D**.
- All the doors are closed.
- Check of the radar sensor system has been successfully completed.

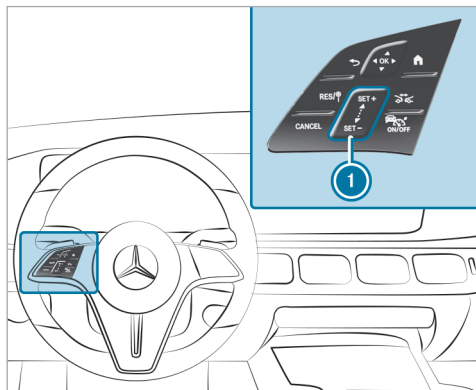

- RES/Ⓢ** Adopts the stored/detected speed
- CANCEL** Deactivating Active Distance Assist DISTRONIC
- 1** Increases/decreases the speed

- Ⓢ** Increases/decreases the specified distance
- DISTRONIC** Activates/deactivates Active Distance Assist DISTRONIC

▶ **To operate Active Distance Assist DISTRONIC:** press the respective button with only one finger or swipe on the control panel.

Activates/deactivates Active Distance Assist DISTRONIC

▶ Press **DISTRONIC**.

Activating Active Distance Assist DISTRONIC

▶ **To activate without a stored speed:** on control panel **1** press **SET/+** on the upper section or **SET/-** on the lower section or **RES/Ⓢ**. Remove your foot from the accelerator pedal.

or

▶ **To activate with a stored speed:** press **RES/Ⓢ**. Remove your foot from the accelerator pedal. The last stored speed is called up and maintained by the vehicle.

If the stored speed has been deleted, the current vehicle speed is stored.

Increasing or reducing the speed

▶ To increase the stored speed: swipe upwards from the bottom of control panel **1**.

- The stored speed is increased by 1 mph (1 km/h).

▶ To decrease the stored speed: swipe downwards from the top of control panel **1**.

- The stored speed is decreased by 1 mph (1 km/h).

or

▶ Briefly press **SET/+** on the upper section or **SET/-** on the lower section of control panel **1**.

The stored speed is increased or reduced by 5 mph (10 km/h).

or

▶ Accelerate the vehicle to the desired speed.

▶ Press **SET/+** on the upper section of control panel **1**.

Adopting the limit speed shown in the driver's display

- ▶ Activate the Active Distance Assist DISTRONIC: Press **SET/+**, **SET/-** or **RES/0**.
- ▶ Accept the displayed speed limit: press **RES/0**. The limit speed displayed in the driver's display is adopted as the stored speed. The vehicle adapts its speed to that of the vehicle in front, but only up to the stored speed, or limits its speed accordingly.

i A speed limit shown in the driver display is adopted only while the vehicle is in motion, not when stationary.



Pulling away with Active Distance Assist DISTRONIC

- ▶ Activate Active Distance Assist DISTRONIC and remove your foot from the brake pedal.
- ▶ Press **RES/0**.

or

- ▶ Depress the accelerator pedal briefly and firmly. The functions of Active Distance Assist DISTRONIC continue to be carried out.

Reducing or increasing the specified distance from the vehicle in front

- ▶ Press . The  display appears. The specified distance is reduced by one level. If the lowest level is already selected, the selection jumps to the highest level.

Deactivating Active Distance Assist DISTRONIC

⚠ WARNING Risk of an accident due to Active Distance Assist DISTRONIC being active when you leave the driver's seat

If you leave the driver's seat while the vehicle is being braked by Active Distance Assist DISTRONIC only, the vehicle can roll away.

- ▶ Always deactivate Active Distance Assist DISTRONIC and secure the vehicle to prevent it from rolling away before you leave the driver's seat.

- ▶ Press **CANCEL**.

i If you brake, deactivate ESP® or if ESP® intervenes, Active Distance Assist DISTRONIC is deactivated.

Function of Active Speed Limit Assist

If a change in the speed limit of 12 mph (20 km/h) or more is detected and automatic adoption of speed limits is activated, the new speed limit is automatically adopted as the stored speed (→ page 259).

The vehicle's speed is adjusted when it is level with the traffic sign at the latest. In the case of signs indicating entry into an urban area, the speed is adapted according to the speed permitted within the urban area. The speed limit display on the driver's display is always updated when the vehicle is level with the traffic sign.

If there is no speed restriction on an unlimited stretch of road (e.g. on a highway), the recommended speed is automatically adopted as the stored speed. The system uses the speed stored on an unlimited stretch of road as the recommended speed. If you do not alter the stored speed on an unlimited stretch of road, the recommended speed is 80 mph (130 km/h).

If Active Distance Assist DISTRONIC has been put into passive mode by pressing the accelerator pedal, only speed limits which are higher than the set speed are adopted.

Observe the notes on driving systems and your responsibility; you may otherwise fail to recognize dangers (→ page 228).

System limits

The system limits of Traffic Sign Assist apply to the detection of traffic signs (→ page 258).

Speed limits below 12 mph (20 km/h) are not automatically adopted by the system as the stored speed. Temporary speed restrictions (e.g. for a certain time or due to weather conditions) cannot be properly detected by the system. The maximum permissible speed applying to a vehicle with a trailer is not detected by the system.

Adjust the speed in these situations.

⚠ WARNING Risk of accident due to Active Speed Limit Assist adapting the vehicle's speed

The speed adopted by Active Speed Limit Assist may be too high or incorrect in some individual cases, such as:

- at speed limits below 12 mph (20 km/h)
- in wet conditions or in fog
- when towing a trailer

▶ Ensure that the driven speed complies with traffic regulations.

▶ Adjust the driving speed to suit current traffic and weather conditions.

Function of route-based speed adaptation

When Active Distance Assist DISTRONIC is activated, the vehicle speed will be adapted accordingly to the route events ahead. Depending on the drive program selected, the vehicle negotiates a route event ahead in an economical, comfortable or dynamic manner. When the route event has been passed, the vehicle accelerates again to the stored speed. The set distance to the vehicle in

front, vehicles detected ahead and speed restrictions ahead are taken into account.

You can activate and deactivate route-based speed adaptation in the multimedia system (→ page 245).

The following route events are taken into account:

- Bends
- T-intersections, traffic circles and toll stations
- Turns and exits
- Traffic jams ahead (only with Live Traffic Information)

i When the toll station is reached, Active Distance Assist DISTRONIC adopts the speed as the stored speed.

Also, the speed is reduced if the turn signal indicator to change lanes is switched on and one of the following situations is detected:

- Turning at intersections
- Driving on slowing-down lanes
- Driving on lanes adjacent to slowing-down lanes

The driver is responsible for choosing the right speed and observing other road users. This applies in particular to intersections, traffic circles and traffic lights because route-based speed adaptation does not brake the vehicle to a standstill.

When route guidance is active, the first speed adjustment is carried out automatically. If the turn signal indicator is switched on, the selected route is confirmed and further speed adjustment is activated.

Speed adaptation is canceled in the following cases:

- If the turn signal indicator is switched off before the route event.
- If the driver depresses the accelerator or brake pedal during the process.

System limits

Route-based speed adaptation does not take right of way regulations into account. The driver is responsible for complying with road traffic regulations and driving at a suitable speed.

The speed adaptation made by the system may not always be suitable, particularly in the following situations:

- the road's course not clearly visible
- Road narrowing
- varying maximum permissible speeds in individual lanes, for example at toll stations
- wet road surfaces, snow or ice
- when towing a trailer

In these situations the driver must intervene accordingly.

⚠ WARNING Risk of accident in spite of route-based speed adaptation

Route-based speed adaptation can malfunction or be temporarily unavailable in the following situations:

- If the driver does not follow the calculated route
- If map data is not up-to-date or available
- In the event of roadworks

- In bad weather or road conditions
 - If the accelerator pedal is depressed
 - In the event of electronically displayed speed limitations
- ▶ Adapt the speed to the traffic situation.

■ Setting Active Distance Assist DISTRONIC driving styles

Requirements

- Active Distance Assist DISTRONIC is activated.

Multimedia system:

📶 🏠 ▶▶ Settings ▶▶ Assistance
▶▶ Driving ▶▶ Active Distance Assist

Setting speed adaptation

▶ Select **Adopt Speed Limit** or **Route-based Speed Adaptation**.

When these functions are active, the vehicle speed is adjusted depending on a route event ahead or a speed limit.

- ① When one of the following systems is active, the detected speed can be manually adopted as the speed limit:
 - Active Distance Assist DISTRONIC
 - Variable limiter
- ① Further information on speed adaptation (→ page 244).

■ Function of Active Stop-and-Go Assist

Active Stop-and-Go Assist helps you when in traffic jams on multi-lane roads with separate roadways by automatically pulling away within up to 60 seconds and with moderate steering maneuvers. It orients itself using the vehicle in front and lane markings. Active Stop-and-Go Assist automatically maintains a safe distance from the vehicle in front and vehicles cutting in.

Active Stop-and-Go Assist requires you, as the driver, to keep your hands on the steering wheel at all times so that you are able to intervene at any time to correct the course of the vehicle and keep it in lane. Observe the notes on driving systems and your responsibility; you may otherwise fail to recognize dangers (→ page 228).

Active Stop-and-Go Assist activates automatically as soon as all of the requirements are met: The  status display appears on the driver's display when the function is active.

Requirements:

- You are in a traffic jam on a highway or high-speed major road.
- Active Distance Assist DISTRONIC is activated and active (→ page 241).
- Active Brake Assist is available (→ page 253).
- Active Steering Assist is activated and active (→ page 250).
- You are traveling no faster than 35 mph (60 km/h).

System limits



The system limitations of Active Distance Assist DISTRONIC and Active Steering Assist apply to Active Stop-and-Go Assist.

DSR (Downhill Speed Regulation)

■ Function of DSR

DSR is an aid to assist you when driving downhill. It keeps the speed of travel at the selected target speed. The steeper the downhill gradient, the greater the DSR braking effect on the vehicle. On flat stretches of road and uphill gradients, the DSR brakes the vehicle minimally or not at all.

When DSR is activated and the transmission is in position **D**, **R** or **N**, DSR controls the driving speed. The target speed can be set to a value between 1 mph (2 km/h) and 11 mph (18 km/h). By braking or accelerating, you can drive at a higher or lower speed than the target speed at any time.

If you drive faster than 28 mph (45 km/h) or change the drive program (except in ) DSR switches off automatically. The  Off message appears on the driver's display. The status indicator on the driver's display goes out. You also hear a warning tone.

Information on DSR

⚠ WARNING Risk of skidding and accident when DSR is activated on slippery road surfaces

If the driven speed and the target speed differ, the wheels may lose traction.

- ▶ Take into account the road surface and the difference between the driving speed and target speed before activating DSR.

Observe the notes on driving systems and your responsibility; you may otherwise fail to recognize dangers (→ page 228).



You are always responsible for keeping control of the vehicle and for assessing whether the downhill gradient can be negotiated. Depending on road surface and tires, DSR may not always be able to keep to the target speed. Select a target speed suitable for the environmental conditions and also apply the brakes yourself if required.

Activating/deactivating DSR (with Offroad package or E-ACTIVE BODY CONTROL)

Requirements:

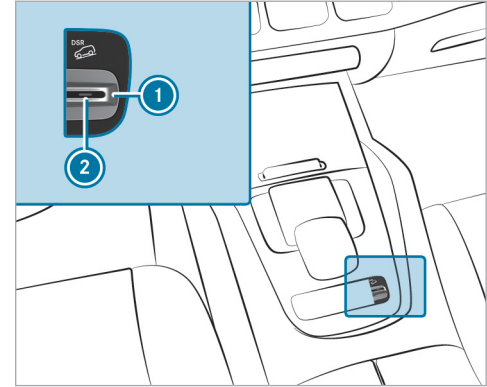
- You are driving at 24 mph (40 km/h) or slower.
If the current vehicle speed is too high, the **Max. Speed 25 mph** message appears on the driver's display.
- You have not selected drive program **S**.
- Active Distance Assist DISTRONIC is deactivated.



- ▶ **To activate:** pull rocker switch ①. Indicator lamp ② lights up.
The  symbol appears on the driver's display.
- ▶ **To deactivate:** pull rocker switch ①. Indicator lamp ② and the  symbol go out.

■ Activating or deactivating DSR (Downhill Speed Regulation)

Requirements

- You are driving at 24 mph (40 km/h) or slower.
If the vehicle speed is too high, the **Max. speed 40 km/h** message appears on the driver's display.
- Active Distance Assist DISTRONIC, cruise control and the variable limiter are switched off.

Multimedia system:

→  » Settings » Assistance

▶ Select .

A status display appears on the driver's display when the function is activated.

■ Changing the target speed

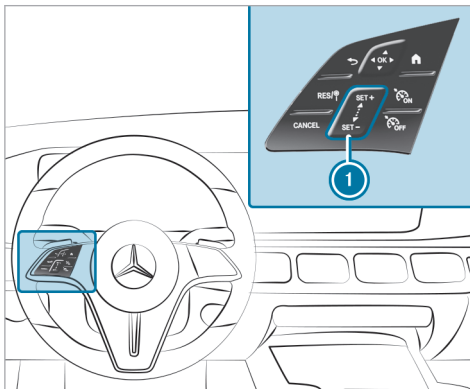

- ▶ **To increase/reduce the target speed:** press **SET+** or **SET-** on control panel ①. The selected target speed is increased or reduced by 1 mph (1 km/h) and appears next to the  symbol on the driver's display.

Active Steering Assist



■ Function of Active Steering Assist





Active Steering Assist is available up to a speed of 130 mph (210 km/h). The system helps you to stay in the center of the lane by means of moderate steering interventions. Depending on the speed at which you are driving, Active Steering Assist uses the vehicles ahead and lane markings as a reference.

- ① Depending on the country, Active Steering Assist can use the surrounding traffic as a reference in the lower speed range. If necessary, Active Steering Assist can then also provide assistance when driving outside the center of the lane to form an emergency corridor, for example.

If the detection of lane markings and vehicles ahead is impaired, Active Steering Assist switches to passive mode. The system provides no support in this case.

Status display of Active Steering Assist

-  (gray): activated and passive
-  (green): activated and active

-  (red): system limits detected
 -  (white, red hands): "hands on the steering wheel" prompt
- i** During the transition from active to passive status, the  symbol is shown as enlarged and flashing. When the passive state is reached, the  symbol is displayed in gray.
- i** Depending on the selected vehicle settings, Active Steering Assist may be unavailable.

Steering and touch detection

The driver is required to keep their hands on the steering wheel at all times and be able to intervene at any time to correct the course of the vehicle and keep it in lane. The driver must expect a change from active to passive mode or vice versa at any time.

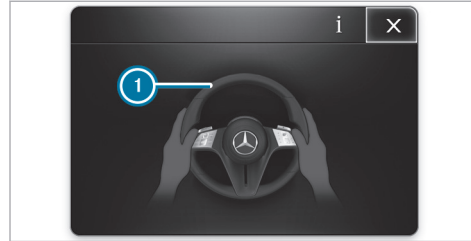

If the system detects that the driver has not steered the vehicle for a considerable period of time or has removed their hands from the steering wheel, display **1** appears. If the driver still does not steer the vehicle, a warning tone sounds in addition to the visual warning message.

If the driver does not react to the warning for a considerable period, the system may initiate an emergency stop (→ page 250).

The warning is not issued or is stopped as soon as the system detects that the driver is touching the steering wheel or steering.

Touch detection may be limited or may not function if there is no direct contact between hand

and steering wheel, e.g. when you are wearing gloves or if there is a steering wheel cover on the steering wheel.

If Active Steering Assist detects that a system limit has been reached, a visual warning is issued and a warning tone sounds.

Observe the notes on driving systems and your responsibility; you may otherwise fail to recognize dangers (→ page 228).

System limits

Active Steering Assist has a limited steering torque for lateral guidance. In some cases, the steering intervention is not sufficient to keep the vehicle in the lane or to drive through exits.

The system may be impaired or may not function in the following instances:

- There is poor visibility, e.g. due to snow, rain, fog, heavy spray, highly variable light conditions or strong shadows on the road.
- There is glare, e.g. from oncoming traffic, direct sunlight or reflections.
- Insufficient illumination of the road.

- The windshield is dirty, fogged up, damaged or covered in the vicinity of the camera, e.g. by a sticker.
- No, or several, unclear lane markings are present for one lane, or the markings change quickly, such as in a construction area or at intersections.
- The lane markings are worn away, dark or covered up, e.g. by dirt or snow.
- If the distance to the vehicle in front is too short and thus the lane markings cannot be detected.
- The road is narrow and winding.
- There are obstacles in the lane or projecting out into the lane, such as object markers.

The system does not provide assistance in the following conditions:

- On tight bends and when turning.
- When crossing intersections.
- At traffic circles or toll stations.
- When towing a trailer.
- When the tire pressure is too low.

- Vehicles with E-ACTIVE BODY CONTROL: in drive program **[CV]** and at lean level 2 and 3

⚠ WARNING Risk of accident if Active Steering Assist unexpectedly stops functioning

If the system limits of Active Steering Assist are reached there is no guarantee that the system will remain active or will keep the vehicle in lane.

- ▶ Always keep your hands on the steering wheel and observe the traffic carefully.
- ▶ Always steer the vehicle paying attention to traffic conditions.

⚠ WARNING Risk of accident if Active Steering Assist unexpectedly intervenes

The detection of lane markings and objects may malfunction and cause unexpected steering interventions.

- ▶ Steer according to traffic conditions.

■ Activating/deactivating Active Steering Assist

Requirements

- ESP[®] is activated, but is not intervening.
- Active Distance Assist DISTRONIC is activated.

Multimedia system:

→  **▶▶ Settings ▶▶ Assistance**
▶▶ Driving

 Activate or deactivate **Active Steering Assist**.

Function of Active Emergency Stop Assist

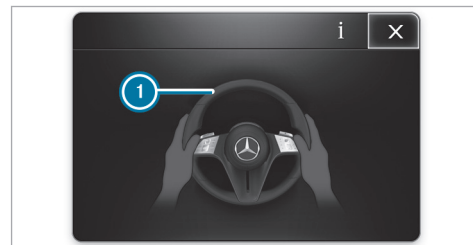

If the system detects that the driver has not steered the vehicle for a considerable period of time or has removed their hands from the steering wheel, display **!** appears. If the driver still does not steer the vehicle, or gives no confirmation to the system, a warning tone sounds in addition to the visual warning message.

If the driver still does not respond to the warning, the **Beginning Emergency Stop** message appears on the driver display. If the driver still does not respond, Active Distance Assist DISTRONIC reduces the speed. The vehicle is decelerated in stages to a standstill.

Depending on the country, at speeds below 40 mph (60 km/h) the hazard warning lights switch on automatically.

When the vehicle is stationary, the following actions are carried out:

- The vehicle is secured with the electric parking brake.
- Active Distance Assist DISTRONIC is ended.
- The vehicle is unlocked.
- If possible, an emergency call is placed to the Mercedes-Benz emergency call center.

The driver can cancel the deceleration at any time by performing one of the following actions:

- Steering
- Braking or accelerating
- Deactivating Active Distance Assist DISTRONIC

Active Lane Change Assist

■ Function of Active Lane Change Assist

Active Lane Change Assist supports the driver when changing lanes by applying steering torque if the driver activates a turn signal indicator.

Observe the notes on driving systems and your responsibility; you may otherwise fail to recognize dangers (→ page 228).

Assistance when changing lanes is provided if all the following conditions are met:

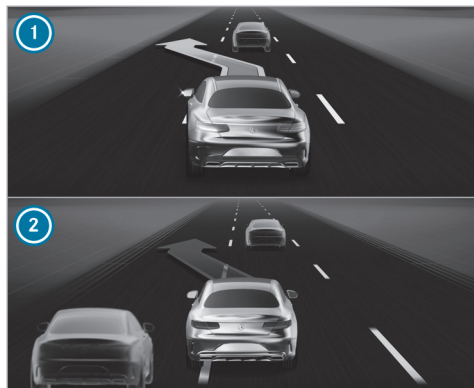

- You are driving on a freeway or road with multiple lanes in the direction of travel.
- The neighboring lane is separated by a broken lane marking.
- No vehicle is detected in the adjacent lane.
- The vehicle speed is between 50 mph (80 km/h) and 110 mph (180 km/h).
- Active Lane Change Assist is switched on in the multimedia system.
- Active Steering Assist is activated and active.



Display on the driver's display in the **Assistance** menu

- ① Green arrow: lane change initiated
- ② Red arrow: lane change canceled

If no vehicle is detected in the adjacent lane and a lane change is permitted, the lane change begins after the driver has activated the turn signal indicator. This is indicated to the driver by a green flashing arrow next to the steering wheel symbol

. The message **Lane Change to the Left**, for example, also appears. If Active Lane Change Assist is activated with the turn signal indicator, but a lane change is not possible immediately, only the green flashing arrow appears next to the steering wheel symbol , which remains green.

As soon as the lane change assistance starts, the turn signal indicator is automatically activated.

If a lane change is not possible, the arrow is faded out after a few seconds and a new lane change must be initiated. An immediate lane change is only possible on freeway sections without speed limits.

In addition, a warning tone may sound, depending on the situation.

⚠ WARNING Risk of accident when changing lane to an occupied adjacent lane

Lane Change Assist cannot always clearly detect if the adjacent lane is free.

The lane change might be initiated although the adjacent lane is not free.

- ▶ Before changing lanes, make sure that the neighboring lane is free and there is no danger to other road users.
- ▶ Monitor the lane change.

⚠ WARNING Risk of accident if Lane Change Assist unexpectedly stops functioning

If the system limitations for Lane Change Assist have been reached, there is no guarantee that the system will remain active.

Lane Change Assist cannot then assist you by applying steering torque.

- ▶ Always monitor the lane change and keep your hands on the steering wheel. Observe the traffic conditions and steer and/or brake if necessary.

System limits

The system limits of Active Steering Assist apply to Active Lane Change Assist (→ page 248).

The system may also be impaired or may not function in the following situations:

- The sensors in the rear bumper are dirty, damaged or covered by a sticker or ice and snow, for example.
- The exterior lighting shows a defect.

i The Active Lane Change Assist sensors adjust automatically while a certain distance is being driven after the vehicle has been delivered. Active Lane Change Assist is unavailable during this teach-in process; no arrow appears next to the Active Steering Assist symbol  when the turn signal indicator is activated.

Setting Active Lane Change Assist

Multimedia system:

-  » Settings » Assistance
- » Driving » Active Lane Change Assist
- ▶ Select **Active Lane Change Assist**.
- ▶ Choose between the **On** and **Off** (Off) setting options.

i If **Active Steering Assist** has been switched off, it will not be possible to operate **Active Lane Change Assist**.

Active Brake Assist

Function of Active Brake Assist

Active Brake Assist consists of the following functions:

- Collision warning
- Autonomous braking function
- Situation-dependent brake force boosting
- **Vehicles with Driving Assistance Package:** Evasive Steering Assist and cornering function

Active Brake Assist can help you to minimize the risk of a collision with vehicles, cyclists or pedestrians or to reduce the effects of such a collision.

If Active Brake Assist has detected a risk of collision, a warning tone will sound and the Active Brake Assist warning lamp  will light up.

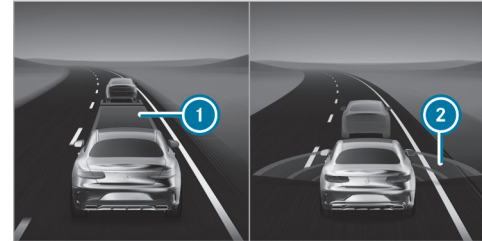

In the **Assistance** menu, an insufficient distance **1** to the vehicle in front is displayed in red. If you further reduce the distance, the vehicle in front will also be highlighted in red. When the system detects a risk of collision, red radar waves **2** appear in front of the vehicle.

Vehicles with PRE-SAFE®: depending on the country, an additional haptic warning will occur in the form of slight, repeated tensioning of the seat belt.

If you do not react to the warning, autonomous braking can be initiated in critical situations.

In especially critical situations, Active Brake Assist can initiate autonomous braking directly. In this

case, the warning lamp and warning tone occur simultaneously with the braking application.

If you apply the brake yourself in a critical situation or apply the brake during autonomous braking, situation-dependent brake force boosting will occur. The brake pressure will increase up to maximum full-stop braking if necessary.

Observe the notes on driving systems and your responsibility; you may otherwise fail to recognize dangers (→ page 228).



If autonomous braking or situation-dependent brake force boosting has occurred, pop-up ① will appear on the driver's display and then automatically disappear after a short time.

If the autonomous braking function or situation-dependent brake force boosting is triggered, additional preventive measures for occupant protection (PRE-SAFE®) may also be initiated.

⚠ WARNING Risk of an accident caused by limited detection performance of Active Brake Assist

Active Brake Assist cannot always clearly identify objects and complex traffic situations.

In such cases, Active Brake Assist might:

- Give a warning or brake without reason
- Not give a warning or not brake

Active Brake Assist is only an aid. The driver is responsible for maintaining a sufficiently safe distance to the vehicle in front, vehicle speed and for braking in good time.

- ▶ Always pay careful attention to the traffic situation; do not rely on Active Brake Assist alone.
- ▶ Be prepared to brake or swerve if necessary.

If Active Brake Assist is deactivated or the functions are restricted, e.g. due to activation of another driving system, the  display message will appear on the driver's display.

If the system is unavailable due to dirty or damaged sensors or due to a malfunction, or if the functions are restricted, the  warning lamp will appear on the driver's display.

Also observe the system limits of Active Brake Assist.

The individual subfunctions are available in various speed ranges

The distance warning function can issue a warning in the following situations:

- From approximately 4 mph (7 km/h), if your vehicle is critically close to a vehicle, cyclist or pedestrian, you will hear an intermittent warning tone and the distance warning lamp  will light up on the driver's display.

Vehicles with PRE-SAFE®: depending on the country, an additional haptic warning will occur in the form of slight, repeated tensioning of the seat belt.

Brake immediately or take evasive action, provided it is safe to do so and the traffic situation allows this.

Collision warning (vehicles without Driving Assistance Package)

The collision warning can aid you in the following situations with an intermittent warning tone and a warning lamp:

- From approximately 4 mph (7 km/h), if your vehicle is critically close to a vehicle, cyclist or pedestrian, you will hear an intermittent warning tone and the distance warning lamp  will light up on the driver's display.

Vehicles with PRE-SAFE®: depending on the country, an additional haptic warning will occur in the form of slight, repeated tensioning of the seat belt.

- At speeds up to approximately 155 mph (250 km/h) when approaching vehicles ahead
- At speeds up to approximately 50 mph (80 km/h) when approaching stationary vehicles, moving pedestrians, and cyclists ahead

- At speeds up to approximately 37 mph (60 km/h) when approaching crossing cyclists

Collision warning (vehicles with Driving Assistance Package)

The collision warning can aid you in the following situations with an intermittent warning tone and a warning lamp:

- At speeds up to approximately 155 mph (250 km/h) when approaching vehicles ahead
- At speeds up to approximately 62 mph (100 km/h) when approaching stationary vehicles
- At speeds up to approximately 50 mph (80 km/h) when approaching moving pedestrians and cyclists ahead
- At speeds up to approximately 43 mph (70 km/h) when approaching stationary pedestrians, crossing vehicles and stationary and crossing cyclists

Autonomous braking function (vehicles without Driving Assistance Package)

If the vehicle is traveling at speeds above approximately 4 mph (7 km/h), the autonomous braking function may intervene in the following situations:

- At speeds up to approximately 124 mph (200 km/h) when approaching vehicles ahead
- At speeds up to approximately 50 mph (80 km/h) when approaching cyclists ahead
- At speeds up to approximately 37 mph (60 km/h) when approaching moving pedestrians, crossing cyclists, and stationary vehicles

Autonomous braking function (vehicles with Driving Assistance Package)

If the vehicle is traveling at speeds above approximately 4 mph (7 km/h), the autonomous braking function may intervene in the following situations:

- At speeds up to approximately 155 mph (250 km/h) when approaching vehicles ahead
- At speeds up to approximately 62 mph (100 km/h) when approaching stationary vehicles

- At speeds up to approximately 50 mph (80 km/h) when approaching cyclists ahead
- At speeds up to approximately 43 mph (70 km/h) when approaching stationary and moving pedestrians, crossing vehicles and stationary and crossing cyclists

Situation-dependent brake force boosting (vehicles without Driving Assistance Package)

Situation-dependent brake force boosting may intervene from a speed of approximately 4 mph (7 km/h) in the following situations:

- At speeds up to approximately 155 mph (250 km/h) when approaching vehicles ahead
- At speeds up to approximately 50 mph (80 km/h) when approaching stationary vehicles and cyclists ahead
- At speeds up to approximately 37 mph (60 km/h) when approaching moving pedestrians and crossing cyclists

Situation-dependent brake force boosting (vehicles with Driving Assistance Package)

Situation-dependent brake force boosting may intervene from a speed of approximately 4 mph (7 km/h) in the following situations:

- At speeds up to approximately 155 mph (250 km/h) when approaching vehicles ahead
- At speeds up to approximately 62 mph (100 km/h) when approaching stationary vehicles
- At speeds up to approximately 50 mph (80 km/h) when approaching cyclists ahead
- At speeds up to approximately 37 mph (60 km/h) when approaching stationary and moving pedestrians, crossing vehicles, and stationary and crossing cyclists

Canceling a brake application of Active Brake Assist

You can cancel a brake application of Active Brake Assist at any time by:

- sharply depressing the accelerator pedal or with kickdown
- releasing the brake pedal

Active Brake Assist may cancel the brake application when one of the following conditions is fulfilled:

- You maneuver to avoid an obstacle
- There is no longer a risk of collision
- An obstacle is no longer detected in front of your vehicle

Evasive Steering Assist (only vehicles with Driving Assistance Package)

Evasive Steering Assist has the following characteristics:

- The ability to detect stationary or moving pedestrians.
- Assistance through power-assisted steering if a swerving maneuver is detected.
- Activation through an abrupt steering movement during a swerving maneuver.
- Assistance during swerving and straightening of the vehicle.
- Reaction from a speed of approximately 12 mph (20 km/h) up to a speed of approximately 43 mph (70 km/h).

You can prevent the assistance at any time by actively steering.

Cornering function (only vehicles with Driving Assistance Package)

If the system detects a risk of a collision with an oncoming vehicle when turning across an oncoming lane, autonomous braking can be initiated at speeds below 9 mph (15 km/h) before you have left the lane in which you are driving.

⚠ WARNING Risk of accident despite Evasive Steering Assist

Evasive Steering Assist cannot always recognize objects or complex traffic situations clearly.

Moreover, the steering support provided by Evasive Steering Assist is not sufficient to avoid a collision.

- ▶ Always pay careful attention to the traffic situation; do not rely on Evasive Steering Assist alone.
- ▶ Be prepared to brake or swerve if necessary.

- ▶ End the support by actively steering in non-critical situations.
- ▶ Drive at an appropriate speed if there are pedestrians close to the path of your vehicle.

System limits

Full system performance is not available for a short time after switching on the vehicle or after driving off. Depending on the environmental conditions, it may take a few minutes before full system performance is available.

The system may be impaired or may not function, particularly in the following situations:

- In snow, rain, fog, heavy spray, direct sunlight or highly variable light conditions, or if there is glare.
- If the sensors are dirty, fogged up, damaged or covered.
- If the sensors are impaired due to interference from other radar sources, e.g. strong radar reflections in parking garages.
- If a loss of tire pressure or a defective tire has been detected and displayed.

- If DSR is active.
- In complex traffic situations where objects cannot always be clearly identified.
- If pedestrians or vehicles move quickly into the sensor detection range.
- If pedestrians are hidden by other objects.
- If the typical outline of a pedestrian cannot be distinguished from the background.
- If a pedestrian is not detected as such, e.g. due to special clothing or other objects.
- If the driver's seat belt is not fastened.
- On bends with a tight radius.

- ① The Active Brake Assist sensors adjust automatically while a certain distance is being driven after the vehicle has been delivered. Active Brake Assist is unavailable or only partially available during the teach-in process.

■ Setting Active Brake Assist

Requirements

- The vehicle is switched on.

Multimedia system:

→  ▶ Settings ▶ Assistance
▶ Collision Avoidance

▶ Activate or deactivate the function.

- ❶ It is recommended that you always leave Active Brake Assist activated.

When Active Brake Assist is deactivated, the distance warning function, the collision warning, the autonomous braking function and Evasive Steering Assist will be deactivated.

- ❶ If Active Brake Assist is deactivated, the  symbol will appear on the status bar of the driver's display, and the system will be reactivated the next time the vehicle is started.

Setting the time of the warnings

- ▶ Select  next to **Active Brake Assist**.
- ▶ Select **Early**, **Medium** or **Late**.

Traffic Sign Assist

Function of Traffic Sign Assist

Traffic Sign Assist detects traffic signs with the multifunction camera (→ page 228). It assists

you by displaying detected speed limits and overtaking restrictions on the driver display.

Observe the notes on driving systems and your responsibility; you may otherwise fail to recognize dangers (→ page 228).

Since Traffic Sign Assist also uses the data stored in the navigation system, it can update the display in the following situations without detecting traffic signs.

The camera also detects traffic signs with a restriction indicated by an additional sign (e.g. when wet). These are only displayed if a restriction applies or if the system cannot clearly determine whether the restriction applies.

Warning when the maximum permissible speed is exceeded

The system can warn you if you unintentionally exceed the maximum permissible speed. Depending on the country, you can set in the multimedia system by how much the maximum permitted speed may be exceeded before a warning is given. You can specify whether the warning is to be just a visual warning or an acoustic one as well.

Displays in the driver's display

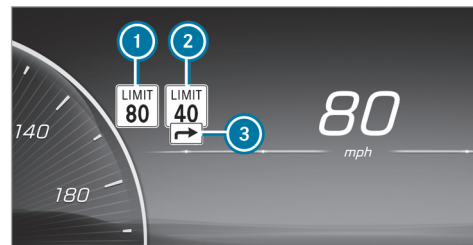

- ❶ Permissible speed
- ❷ Permissible speed when there is a restriction
- ❸ Additional sign with restriction

The system can show up to two traffic signs in the driver's display simultaneously. The system always prioritizes displaying speed limits. Up to one traffic sign with a maximum permissible speed can be shown in the head-up display. If two speed signs are shown in the driver display, e.g. in the case of detected restrictions, the value of the left-hand speed limit ❶ is always transmitted to the TEM-POMAT or Active Distance Assist DISTRONIC for acceptance and shown in the head-up display.

Traffic Sign Assist also uses data from the digital street map in the navigation system. When you leave or enter a municipality or change roads, on a highway exit or slip road for example, or after you turn at an intersection, the display in the driver's display can thus be updated without a traffic sign having been detected.

If Traffic Sign Assist cannot determine the currently applicable maximum permissible speed (e.g. due to missing signs), the following display appears in the driver's display:



Traffic Sign Assist is not available in all countries. If the vehicle is in a country where Traffic Sign Assist is not supported, this is displayed continuously.

System limits

The system may be impaired or may not function particularly in the following situations:

- If there is poor visibility, e.g. due to insufficient illumination of the road, highly variable shade conditions, rain, snow, fog or heavy spray.
- If there is glare, e.g. from oncoming traffic, direct sunlight or reflections.
- If there is dirt on the windshield in the vicinity of the multifunction camera or if the camera is fogged up, damaged or obscured.
- If the traffic signs are hard to detect, e.g. due to dirt, snow or insufficient lighting, or because they are obscured.
- If the information on the navigation system's digital map is incorrect or out of date.
- If signs are ambiguous, e.g. road signs in roadworks or in adjacent lanes.
- If you turn sharply when passing traffic signs outside the camera's field of vision.

Setting Traffic Sign Assist

Multimedia system:

>> Settings >> Assistance
 >> Assistance >> Traffic Sign Assist

Activating or deactivating the speed warning

- ▶ Switch off **Speed Limit Warning**.
The speed warning remains off according to country-specific legislation until the next time the vehicle is switched on or off and the driver's door is opened.

Change the type of speed warning

- ▶ Change the warning to **Visual only** or **Visual and acoustic**.

Setting the warning threshold

This value determines the speed at which a warning is issued when exceeded.

- ▶ Set the desired speed under **Warning Threshold**.

Activating or deactivating further functions of Traffic Sign Assist

- ▶ Switch further warning contents on or off.
The available functions are switched on or off.

Set the type of warning for other functions

- ▶ Select **Visual only** or **Visual and acoustic**.

Traffic light view

Information about the traffic light view

The traffic light view supports the driver when waiting in front of a red light by displaying the camera image on the central display. The camera image is displayed when the driver is the first vehicle in front of the red light and faded out when the vehicle drives off.

Displaying traffic light view

Requirements:

- The **Traffic Light View** option is switched on .
- A traffic light view is available.



Multimedia system:

➔  ➔ Settings ➔ Assistance
➔ Assistance ➔ Traffic Light View

 This function is not available in all countries.

If the vehicle is in first position at a traffic light, the camera image with traffic light view is shown on the central display.

When the vehicle pulls away, the camera image is faded out.

- ▶ Activate  or deactivate  **Traffic Light View**.

Using other available functions

- ▶ Select .
- ▶ Select **On Request** or **Automatic**.
If **On Request** is set and a traffic light view is available, the **Tap Here for Traffic Light View** message is displayed. The camera image is shown after confirmation of the message.
When **Automatic** is set, the camera image is automatically displayed when the traffic light view is available.



Blind Spot Assist and Active Blind Spot Assist with exit warning

Function of Blind Spot Assist and Active Blind Spot Assist with exit warning

Blind Spot Assist and Active Blind Spot Assist use two lateral, rear-facing radar sensors to monitor the area up to 130 ft (40 m) behind and 10 ft (3 m) next to your vehicle.

If a vehicle is detected at speeds above approximately 8 mph (12 km/h) and this vehicle subsequently enters the monitoring range directly next to your vehicle, the warning lamp in the outside mirror lights up red.

Status display:

-  (gray): system is activated but inoperative
-  (green): system is activated and operational

If a vehicle is detected close to your vehicle and you switch on the turn signal indicator in the corresponding direction, a double warning tone sounds and the red warning lamp in the outside mirror flashes. If the turn signal indicator remains

switched on, all other detected vehicles are indicated only by the flashing of the red warning lamp.

If you overtake a vehicle quickly, no warning is given.

⚠ WARNING Risk of accident despite Active Blind Spot Assist

Active Blind Spot Assist does not react to the following:

- if you overtake a vehicle too closely so that it is in the blind spot area
- if vehicles traveling at a much faster speed approach and then overtake

Active Blind Spot Assist may not give warnings or intervene in such situations.

- ▶ Always pay careful attention to the traffic situation and maintain a safe distance at the side of the vehicle.

Observe the notes on driving systems and your responsibility; you may otherwise fail to recognize dangers (→ page 228).

Exit warning

The exit warning is an additional function of Blind Spot Assist and can warn vehicle occupants about approaching vehicles when leaving the vehicle when stationary.

⚠ WARNING Risk of accident despite exit warning

The exit warning neither reacts to stationary objects nor to persons or road users approaching you at a greatly differing speed.

The exit warning cannot warn drivers in these situations.

- ▶ Always pay particular attention to the traffic situation when opening the doors and make sure there is sufficient clearance.

If there is a vehicle in the monitoring range, this is indicated in the outside mirror. If a vehicle occupant opens the door on the side with the warning, a warning tone sounds and the warning lamp in the outside mirror starts to flash.

This additional function is available only when Blind Spot Assist is active. When the exit warning is activated, it can warn vehicle occupants for up to three minutes after switching the vehicle off. The exit warning is no longer available once the warning lamp in the outside mirror flashes three times.

The exit warning is only an aid and not a substitute for the attention of vehicle occupants. The responsibility for opening and closing the doors and for leaving the vehicle remains with the vehicle occupants.

System limits

Blind Spot Assist and Active Blind Spot Assist may be limited in the following situations, in particular:

- if there is dirt on the sensors or the sensors are obscured
- in poor visibility, e.g. due to fog, heavy rain or snow
- if there are narrow vehicles, e.g. bicycles or motorbikes
- if the road has very wide or narrow lanes

- if vehicles are not driving in the middle of their lane

Warnings may be issued in error when driving close to crash barriers or similar continuous lane borders. Always make sure that there is sufficient distance to the side for other traffic or obstacles.

Warnings may be interrupted when you are driving alongside long vehicles (e.g. trucks) for a prolonged time.

Blind Spot Assist is not operational when reverse gear is engaged.

Blind Spot Assist and the exit warning are not operational when a trailer is coupled to the vehicle and the electrical connection has been correctly established.

The exit warning may be limited in the following situations:

- when the sensors are covered by adjacent vehicles in narrow parking spaces
- when people approach the vehicle
- in the event of stationary or slowly moving objects

Function of brake application (Active Blind Spot Assist)

If Active Blind Spot Assist detects a risk of a side impact in the monitoring range, a course-correcting brake application is carried out. This is designed to help you avoid a collision.

The course-correcting brake application is available in the speed range between approximately 20 mph (30 km/h) and 125 mph (200 km/h).

⚠ WARNING Risk of accident despite brake application of Active Blind Spot Assist

A course-correcting brake application cannot always prevent a collision.

- ▶ Always steer, brake or accelerate yourself, especially if Active Blind Spot Assist warns you or makes a course-correcting brake application.
- ▶ Always maintain a safe distance at the sides.



If a course-correcting brake application occurs, the red warning lamp flashes in the outside mirror and a warning tone sounds. In addition, a display **ⓘ** indicating the danger of a side collision appears in the driver's display.

In rare cases, the system may make an inappropriate brake application. This brake application may be interrupted at any time if you steer slightly in the opposite direction or accelerate.

System limits

Note the system limitations of Active Blind Spot Assist; you may otherwise not recognize the dangers (→ page 260).

Either a course-correcting brake application appropriate to the driving situation, or none at all, may occur in the following situations:

- Vehicles or obstacles, e.g. crash barriers, are located on both sides of your vehicle.
- A vehicle approaches too closely on the side.
- You have adopted a sporty driving style with high cornering speeds.
- You brake or accelerate significantly.
- A driving safety system intervenes, e.g. ESP® or Active Brake Assist.
- ESP® is deactivated.
- A loss of tire pressure or a defective tire is detected.
- You are driving with a trailer and the electrical connection to the trailer hitch has been correctly established.

■ Activating/deactivating Blind Spot Assist or Active Blind Spot Assist

Multimedia system:

→  ▶ Settings ▶ Assistance
▶▶ Collision Avoidance

▶ Activate or deactivate **Active Blind Spot Assist**.

Active Lane Keeping Assist

■ Function of Active Lane Keeping Assist

Active Lane Keeping Assist monitors the area in front of your vehicle by means of the multifunction camera (→ page 228) and can warn you before you leave your lane unintentionally. The system can guide you back into your lane through a course-correcting steering intervention and additionally warns you with vibration pulses in the steering wheel. Active Lane Keeping Assist is available in the speed range between approximately 37 mph (60 km/h) and 130 mph (210 km/h).

The system can intervene in the following situations:

- Active Lane Keeping Assist detects a lane marking.
- One of your front wheels goes over a lane marking.

If you activate the turn signal indicator, a steering intervention does not occur on the corresponding side.

If you leave the lane without activating the turn signal indicator, but danger of a collision with a moving obstacle is detected in your lane, a steering intervention does not occur.

Vehicles with Blind Spot Assist or Driving Assistance Package: if the system detects an obstacle, such as another vehicle in the adjacent lane, a steering intervention will occur regardless of the turn signal indicator.

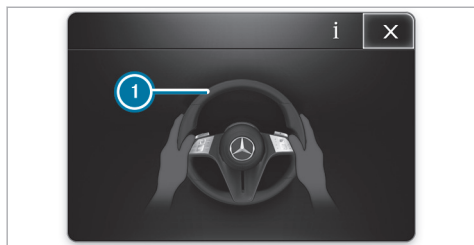

Display ❶ will appear in the driver's display and a warning tone will sound in the following situations:

- A steering intervention by Active Lane Keeping Assist lasts longer than approximately ten seconds.
- The system carries out two or more steering interventions within approximately three minutes without any steering intervention from the driver.

In the Active Lane Keeping Assist settings, you can set the sensitivity of the system and set the level of support. Additionally, you can set whether the system should react to discontinuous lane

markings or only continuous lane markings (→ page 265).

Status displays for Active Lane Keeping Assist



White: Active Lane Keeping Assist is deactivated.

If ESP® is deactivated or a tire pressure loss warning is displayed, Active Lane Keeping Assist is automatically deactivated.



Yellow: there is a malfunction. Please also observe the display messages.



Gray: Active Lane Keeping Assist is activated, but not operating.



Green: Active Lane Keeping Assist is activated and operating.



Red: Active Lane Keeping Assist has guided you back into your lane with a course-correcting steering intervention. The status display will flash if there is also a haptic warning in the steering wheel. The lane marking is shown in red only on the side for which there is a warning.

Active Lane Change Assist display in the "Assistance" menu



If the front wheel of the vehicle drives over a detected lane marking, this will be highlighted red in the **Assistance** menu in the driver's display.

System limits

In the following situations, a lane-correcting steering intervention may not occur but rather a warning may be given on the steering wheel, depending on the situation:

- You clearly and actively steer, brake or accelerate.

- If a driving safety system intervenes, such as ESP®, Active Brake Assist or Active Blind Spot Assist.
- You have adopted a sporty driving style with high cornering speeds or high rates of acceleration.
- If transport equipment, foreexample a trailer or bicycle rack, is attached to the trailer hitch and the electrical connection has been correctly established.

The system may be impaired or may not function particularly in the following situations:

- If there is poor visibility, e.g. due to insufficient illumination of the road, highly variable shade conditions, rain, snow, fog or heavy spray.
- If there is glare, e.g. from oncoming traffic, the sun or reflections.
- If there is dirt on the windshield in the vicinity of the multifunction camera or if the camera is fogged up, damaged or obscured.
- If there is dirt on the bumper in the area of the radar sensors, or if they are damaged or covered.

- If there are no lane markings, or several unclear lane markings are present for one lane, e.g. around roadworks.
- If the lane markings are worn, dark or covered.
- If the distance to the vehicle in front is too short and thus the lane markings cannot be detected.
- If the lane markings change quickly, e.g. lanes branch off, cross one another or merge.
- If the road is very narrow and winding.

Observe the notes on driving systems and your responsibility; you may otherwise fail to recognize dangers (→ page 228).

■ Activating/deactivating Active Lane Keeping Assist

Multimedia system:

-  » Settings » Assistance
- » Collision Avoidance
- » Active Lane Keeping Assist

- ▶ Activate or deactivate the function.

Alternatively, Active Lane Keeping Assist can be activated and deactivated via the  quick vehicle access.

- ⓘ The settings after engine start are country-specific.

■ Setting Active Lane Keeping Assist

Multimedia system:

-  » Settings » Assistance
- » Collision Avoidance
- » Active Lane Keeping Assist

Setting the sensitivity

- ▶ Select .
- ▶ Select **Early**, **Med.** or **Late**.

The last selected setting will be adopted the next time the vehicle is started.

- ⓘ The standard setting for this function is dependent on the country.
- ⓘ The function is not available for vehicles with the Driving Assistance package.

Activating or deactivating assistance on dashed lane markings

- ▶ Select **Advanced Support**.

The last selected setting will be adopted the next time the vehicle is started.

- ⓘ The standard setting for this function is dependent on the country.

AIRMATIC

Function of AIRMATIC

! NOTE Mercedes-AMG vehicles

- ▶ Observe the notes in the Supplement. You could otherwise fail to recognize dangers.

AIRMATIC is an air suspension system with variable damping for improved driving comfort. The all-round level control system ensures the best possible suspension and constant ground clearance, even with a laden vehicle. When driving at speed, the vehicle is lowered automatically to improve driving safety and to reduce energy consumption.

You also have the option of manually adjusting the vehicle level.

AIRMATIC includes the following components and functions:

- air suspension with automatic all-round level control
- speed-dependent lowering of the vehicle level
- via the level button () rocker switch) a higher vehicle level can be selected for greater ground clearance
- ADS PLUS (Adaptive Damping System with constant adjustment of damping characteristics)

Suspension setting and vehicle level per drive program

Drive programs **C** and **E**:

- comfortable suspension setting
- adjusting the vehicle to normal level
- lowering the vehicle to low level -1 at speeds above approx. 87 mph (140 km/h)
- raising the vehicle to normal level at speeds below approx. 25 mph (40 km/h)

Drive program **B**, **H** and **EL** (plug-in hybrid):





- comfortable suspension setting
- adjusting the vehicle to normal level
- lowering the vehicle to low level -1 at speeds above approx. 87 mph (140 km/h)
- raising the vehicle to normal level at speeds below approx. 25 mph (40 km/h)

Drive program **S**:

- firmer suspension setting
- setting the vehicle to low level -1 and no speed-dependent lowering of the vehicle
- **Plug-in hybrid:**
 - adjusting the vehicle to normal level
 - lowering the vehicle to low level -1 at speeds above approx. 87 mph (140 km/h)
 - raising the vehicle to normal level at speeds below approx. 25 mph (40 km/h)

Drive program :

- suspension setting for off-road
- **Vehicles without Off-road package:**



- raising the vehicle to off-road level +1 at speeds below approx. 37 mph (60 km/h)
- lowering the vehicle to normal level at speeds above approx. 50 mph (80 km/h) and raising the vehicle to off-road level +1 again at speeds below approx. 30 mph (45 km/h)
- from speeds of approx. 68 mph (110 km/h), switching to 
- **Plug-in hybrid:** from speeds of approx. 68 mph (110 km/h), switching to 
- **Vehicles with Off-road package:**
 - raising the vehicle to off-road level +1 at speeds below approx. 56 mph (90 km/h)
 - at speeds above approx. 68 mph (110 km/h), switching to , lowering the vehicle to normal level and at speeds below approx. 47 mph (75 km/h), it is possible to select 

Individual suspension settings can be called up in drive program  (→ page 194).

When the entry/exit level is activated, the vehicle is lowered to low level -2 to facilitate entering/exiting. When driving at speeds of approximately 19 mph (30 km/h) or above, the entry/exit level is deactivated and the vehicle is raised (→ page 271).

When car wash mode is activated, the vehicle is raised to a significantly higher level for automated car washes. When driving at speeds above approximately 12 mph (20 km/h) car wash mode is deactivated and the vehicle lowered to the vehicle level previously set (→ page 380).

Below a speed of approx. 37 mph (60 km/h), you can also raise the vehicle manually to an off-road level depending on the equipment (→ page 268)

 **Operation with a trailer or bicycle rack:** if transport equipment, such as a trailer or a bicycle rack, is attached to the trailer hitch and the electrical connection has been correctly established, the vehicle always remains at normal level in all drive programs with the exception of . In drive program ,

the vehicle is lowered above speeds of approx. 19 mph (30 km/h) to normal level.

Differences between different vehicle levels compared to the normal level:

Vehicles without Off-road package

- **Car wash level:**
 - Approx. +3.5 in (+90 mm)
- **Off-road level +1:**
 - Approx. +2.4 in (+60 mm)
- **Low level -1:**
 - Approx. -0.6 in (-15 mm)
- **Low level -2 or entry/exit level:**
 - Approx. -1.0 in (-25 mm)

Vehicles with Off-road package

- **Off-road level +3 or car wash level:**
 - Approx. +3.5 in (+90 mm)
- **Off-road level +2:**
 - Approx. +2.4 in (+60 mm)
- **Off-road level +1:**
 - Approx. +1.2 in (+30 mm)

- **Low level -1**
 - Approx. -0.6 in (-15 mm)
 - **Low level -2 or entry/exit level:**
 - Approx. -1.0 in (-25 mm)
-  Car wash level is 1.3 in (30 mm) above the maximum vehicle height (off-road level). Take note of the significantly higher vehicle level in car wash mode, particularly when driving into underground car parks, in order to avoid possible damage.

System limits

AIRMATIC may not be available or have only limited availability in the following cases:

- The overheating protection has been activated due to frequent level changes within a short time. The  warning lamp appears in the driver's display.
After the cooling phase, the system is again available without restriction.

Setting the vehicle level (vehicles with AIR-MATIC)

 **WARNING** Risk of accident because vehicle level is too high

Driving characteristics may be impaired.

The vehicle can drift outwards, for example, when steering or cornering.

- ▶ Choose a vehicle level which is suited to the driving style and the road surface conditions.

 **WARNING** Risk of entrapment from vehicle lowering

When lowering the vehicle, people could become trapped if their limbs are between the vehicle body and the tires or underneath the vehicle.

- ▶ Make sure no one is underneath the vehicle or in the immediate vicinity of the wheel arches when the vehicle is being lowered.

 **WARNING** Risk of becoming trapped due to the vehicle lowering

Vehicles with AIRMATIC or level control: when you unload luggage or leave the vehicle, the vehicle first rises slightly and then returns to the set level shortly afterwards.

You or anyone else in the vicinity of the wheel arches or the underbody could thus become trapped.

The vehicle can also be lowered after being locked.

- ▶ When leaving the vehicle, make sure that nobody is in the vicinity of the wheel arches or the underbody.

 **NOTE** Damage due to vehicle lowering



Parts of the body could be damaged when the vehicle is lowered.

- ▶ Make sure that there are no obstacles such as curbs underneath or in the immediate vicinity of the body when the vehicle is being lowered.

NOTE Mercedes-AMG vehicles

- ▶ Observe the notes in the Supplement. You could otherwise fail to recognize dangers.

Requirements

- The vehicle has been started.
- **Vehicles without Off-road package:**
 - The vehicle is not moving faster than 37 mph (60 km/h).
- **Vehicles with Off-road package:**
 - Off-road level +1: the vehicle is not moving faster than 56 mph (90 km/h).
 - Off-road level +2: the vehicle is not moving faster than 37 mph (60 km/h) in .
 - Off-road level +3: the vehicle is not moving faster than 12 mph (20 km/h) in  and the rear fog lamp is not switched on.
- **When operating with a trailer or bicycle rack and the trailer socket is correctly contacted:**
 - The vehicle is being driven no faster than 19 mph (30 km/h).

- ⓘ Use the normal level in trailer operation. High-level driving is not permitted in trailer operation on public roads.

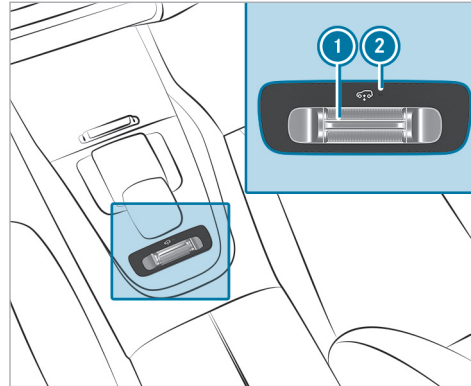
Raising the vehicle (vehicles without Off-road package)

- ▶ Push rocker switch ① forwards. Indicator lamp ② flashes while the vehicle is being raised to off-road level +1 and lights up

continuously when the raising process is complete.

Off-road level +1 set remains stored even after the vehicle has been switched off.

The vehicle is lowered again to the vehicle level of the selected drive program in the following situations:

- When driving faster than 50 mph (80 km/h).
- When driving briefly between 40 mph (65 km/h) and 50 mph (80 km/h).
- You select a different drive program.

Lowering the vehicle (vehicles without Off-road package)

- ▶ Pull rocker switch ①. The vehicle is lowered to the height of the currently selected drive program. Indicator lamp ② flashes while the vehicle is being lowered and goes out when the lowering process is complete.

Raising the vehicle (vehicles with Off-road package)

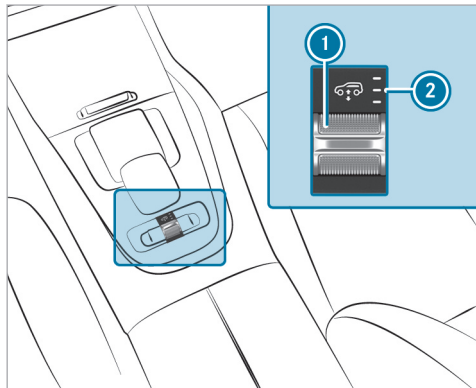

- ▶ Push rocker switch ① forwards. The vehicle rises to the next higher vehicle level.

Following indicator lamps ② flash while the vehicle is being raised and light up continuously when the raising process is complete.

- Off-road level +1: one indicator lamp
- Off-road level +2: two indicator lamps
- Off-road level +3: three indicator lamps

The off-road level set remains stored even after the vehicle has been switched off.

In the following situations, the vehicle is lowered to the next lower vehicle level:

- In off-road level +3:
 - When driving faster than 12 mph (20 km/h).
 - You switch on the rear fog lamps.
- In off-road level +2:
 - When driving faster than 50 mph (80 km/h).
 - When driving briefly between 40 mph (65 km/h) and 50 mph (80 km/h).
- In off-road level +1:

- When driving faster than 68 mph (110 km/h).
- When driving briefly between 62 mph (100 km/h) and 68 mph (110 km/h).

① If you select a different drive program, the vehicle is lowered to the vehicle level of the selected drive program.

Lowering the vehicle (vehicles with Off-road package)

- ▶ Pull rocker switch ①.

The vehicle is lowered to the next lower vehicle level. Indicator lamps ② of the currently selected off-road gear flash while the vehicle is being lowered.

Following indicator lamps ② light up continuously when the lowering process is complete.

- Off-road level +2: two indicator lamps
- Off-road level +1: one indicator lamp
- Normal level: no indicator lamp

The vehicle level set remains stored even after the vehicle has been switched off.

Setting the entering and exiting level (AIR-MATIC)

Requirements

- The vehicle has been started.
- The vehicle is moving at speeds below 20 mph (30 km/h).

Multimedia system:

→  → Settings

→ Schnellzugriff (Quick access)

▶ Select **Lower When Getting In On**.

The vehicle is lowered to low level -2 to facilitate entering and exiting. The selection is stored and the entry/exit level remains stored even after the vehicle is switched off.

In the following situations, the vehicle will be raised to the currently selected vehicle level:

- **Entry/Exit Lowering OFF** is selected.
- After restarting, the vehicle is moving faster than 20 mph (30 km/h).

i The availability of this function depends on the vehicle equipment.

i Further information on AIRMATIC (→ page 266).

Lowering and raising the rear of the vehicle

⚠ WARNING Risk of entrapment from vehicle lowering

When lowering the vehicle, people could become trapped if their limbs are between the vehicle body and the tires or underneath the vehicle.

- ▶ Make sure no one is underneath the vehicle or in the immediate vicinity of the wheel arches when the vehicle is being lowered.

Requirements:

- all vehicle doors are closed
- there is no trailer coupled
- there is no bicycle rack installed
- the battery is sufficiently charged (if necessary, start the engine)

Lowering the rear of the vehicle

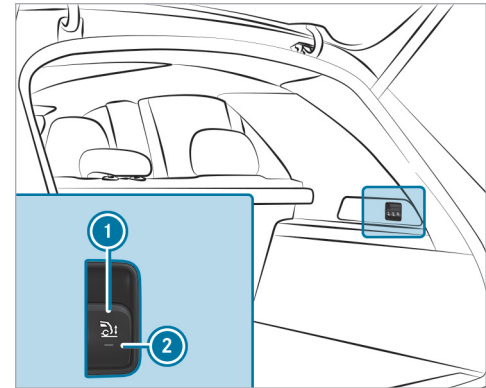

- ▶ Apply the electric parking brake.
- ▶ Shift the transmission to position **P** (→ page 197).
- ▶ Pull switch **1** in the load compartment trim briefly. Indicator lamp **2** flashes until the vehicle has been lowered.

The vehicle is lowered at the rear axle by approx. 1.5 in (40 mm). When the vehicle has been lowered, indicator lamp ② remains lit.

Lowering is interrupted in the following situations:

- a vehicle door is opened.
- switch ① is pulled again.
- the vehicle is being driven faster than 1.2 mph (2 km/h).

① The vehicle is automatically set to the level of the drive program selected if you drive at speeds greater than 1.2 mph (2 km/h).

If indicator lamp ② flashes twice and the rear of the vehicle does not lower:

▶ Make sure that the requirements are met.

① Lowering the rear of the vehicle allows the vehicle to be loaded more easily. Observe the notes on loading the vehicle when doing this (→ page 119).

Raising the rear of the vehicle

▶ Check if the battery is sufficiently charged. If necessary, start the engine.

▶ Pull switch ① briefly. Indicator lamp ② goes out.

The vehicle will be raised to the currently selected level.

① The vehicle is automatically set to the level of the drive program selected if you drive at speeds greater than 1.2 mph (2 km/h).

If the vehicle cannot be raised:

▶ Ensure that the battery is sufficiently charged; if necessary, start the engine. The raising process continues.

E-ACTIVE BODY CONTROL

Function of E-ACTIVE BODY CONTROL

NOTE Mercedes-AMG vehicles

▶ Observe the notes in the Supplement. You could otherwise fail to recognize dangers.

E-ACTIVE BODY CONTROL is an electrohydraulic suspension system with variable damping for improved driving comfort. The all-round level con-

trol system ensures the best possible suspension and constant ground clearance, even with a laden vehicle. When driving at speed, the vehicle is lowered automatically to improve driving safety and to reduce energy consumption. The suspension setting is adjusted depending on the road surface, vehicle load and the drive program selected. In addition, there is the option of setting the vehicle level manually.

The ROAD SURFACE SCAN function detects areas of unevenness in the road before you drive over them by means of a multifunction camera. This reduces chassis movements.

The damping is adjusted individually to each wheel and depends on the following factors:

- Driving style, e.g. sporty
- Road condition, e.g. bumps
- Drive program

E-ACTIVE BODY CONTROL is comprised of the following functions and components:

- **Vehicles with Driving Assistance Package:** ROAD SURFACE SCAN
- Curve inclination function CURVE

- Recovery mode
- Individual wheel control
- Air suspension with automatic level control
- speed-dependent lowering of the vehicle level
- via the level button ( rocker switch) a higher vehicle level can be selected for greater ground clearance
- ADS PLUS (Adaptive Damping System with constant adjustment of damping characteristics)







Suspension setting and vehicle level per drive program

Drive program 

- firmer suspension setting
- adjusting the vehicle to low level -1
- no speed-dependent lowering of the vehicle
- ROAD SURFACE SCAN deactivated
- curve inclination function deactivated



Drive programs   and 

- comfortable suspension setting

- adjusting the vehicle to normal level
- lowering the vehicle to low level -1 at speeds above approx. 87 mph (140 km/h)
- raising the vehicle to normal level at speeds below approx. 25 mph (40 km/h)
- ROAD SURFACE SCAN deactivated ()
- ROAD SURFACE SCAN active (, )
- curve inclination function deactivated (, )
- curve inclination function active ()

Drive program :

- suspension setting for off-road
- **Vehicles without Off-road package:**
 - raising the vehicle to off-road level +1 at speeds below approx. 37 mph (60 km/h)
 - lowering the vehicle to normal level at speeds above approx. 50 mph (80 km/h) and raising the vehicle to off-road level +1 again at speeds below approx. 30 mph (45 km/h)



- from speeds of approx. 68 mph (110 km/h), switching to 
- ROAD SURFACE SCAN deactivated
- curve inclination function deactivated
- recovery mode and individual wheel control possible
- **Vehicles with Off-road package:**
 - raising the vehicle to off-road level +1 at speeds below approx. 56 mph (90 km/h)
 - from speeds above approx. 68 mph (110 km/h), switching to , lowering the vehicle to normal level and at speeds below approx. 47 mph (75 km/h), it is possible to select  again
 - ROAD SURFACE SCAN deactivated
 - curve inclination function deactivated
 - recovery mode and individual wheel control possible

Individual suspension settings can be called up in drive program  (→ page 194).

When the entry/exit level is activated, the vehicle is lowered to low level -2 to facilitate entering/exiting. When driving at speeds of approximately 19 mph (30 km/h) or above, the entry/exit level is deactivated and the vehicle is raised (→ page 271).

When car wash mode is activated, the vehicle is raised to a significantly higher level for automated car washes. When driving at speeds above approximately 12 mph (20 km/h) car wash mode is deactivated and the vehicle lowered to the vehicle level previously set (→ page 380).

Below a speed of approx. 37 mph (60 km/h), you can also raise the vehicle manually to an off-road level depending on the equipment (→ page 268)

i **Operation with a trailer or bicycle rack:** if transport equipment, such as a trailer or a bicycle rack, is attached to the trailer hitch and the electrical connection has been correctly established, the curve inclination function is off and the vehicle always remains at normal level in all drive programs with the exception of . In drive program , the vehicle is lowered above speeds of approx. 19 mph (30 km/h) to normal level.

Differences between different vehicle levels compared to the normal level:

Vehicles without Off-road package

- **Car wash level:**
 - Approx. +3.5 in (+90 mm)
- **Off-road level +1:**
 - +2.4 in (+60 mm)
- **Low level -1**
 - Approx. -0.6 in (-15 mm)
- **Low level -2 or entry/exit level:**
 - Approx. -1.0 in (-25 mm)

Vehicles with Off-road package

- **Off-road level +3 or car wash level:**
 - Approx. +3.5 in (+90 mm)
- **Off-road level +2:**
 - Approx. +2.4 in (+60 mm)
- **Off-road level +1:**
 - Approx. +1.2 in (+30 mm)
- **Low level -1**
 - Approx. -0.6 in (-15 mm)

- **Low level -2 or entry/exit level:**

- Approx. -1.0 in (-25 mm)

i Car wash level is 1.3 in (30 mm) above the maximum vehicle height (off-road level). Take note of the significantly higher vehicle level in car wash mode, particularly when driving into underground car parks, in order to avoid possible damage.

System limits

E-ACTIVE BODY CONTROL may not be available or have only limited availability in the following cases:

- The overheating protection has been activated due to frequent level changes within a short time. The  warning lamp appears in the driver's display.
After the cooling phase, the system is again available without restriction.

Function of ROAD SURFACE SCAN

i This function is not available in all countries. The ROAD SURFACE SCAN function monitors the road in front of your vehicle using a multifunction

camera (→ page 228). ROAD SURFACE SCAN detects unevenness in the road surface, e.g. bumps, before the vehicle drives over them. Chassis movements are reduced and driving comfort is increased.

ROAD SURFACE SCAN is automatically activated if the following conditions are met:

- Drive program **C** or **CV** is selected.
- The vehicle is set to the normal level.
- You are driving at a speed between 4 mph (7 km/h) and 112 mph (180 km/h).

System limits

ROAD SURFACE SCAN may be impaired or may not function in the following situations:

- If the road is insufficiently lit, e.g. at night.
- In snow, rain, fog, heavy spray, direct sunlight or highly variable light conditions, or if there is glare.
- If the windshield in the area of the multifunction camera is dirty, fogged up, damaged or covered.

- If the road surface has no optical structure or reflects light.
- If you are driving too close to the vehicle in front.
- If sections of the route have a very small radius of curvature.
- During abrupt driving maneuvers, e.g. heavy braking or sudden acceleration.

Observe the notes on cleaning the multifunction camera (→ page 383).

Function of recovery mode

⚠ WARNING Risk of injury due to the vehicle moving up and down

During recovery mode, the vehicle moves up and down and can cause injuries.

- ▶ When activating recovery mode, make certain that no one is in the vicinity of the vehicle.

! **NOTE** Risk of damage due to the vehicle moving up and down

When recovery mode is activated, the vehicle springs back in and out automatically and thus moves up and down. Bottoming out can damage the underbody.

- ▶ Make sure that when recovery mode is activated, there is sufficient ground clearance.

Recovery mode is a function of the suspension which can assist the driver on loose surfaces (e.g. sand, snow) when freeing a vehicle which has become stuck.

The vehicle body rocks in slow, vertical motions when recovery mode has been activated. This temporarily puts the wheels under greater load, which means they have increased traction and the vehicle is freed.

You can activate free driving mode via Off-road Assist (→ page 279).

Function of individual wheel control

⚠ WARNING Risk of becoming trapped due to the vehicle lowering

The vehicle can be lowered when the individual wheel control function has been activated. Body parts could become trapped if they are between the vehicle body and the tires or underneath the vehicle.

- ▶ Make sure that nobody is under the vehicle or in the immediate vicinity of the wheel arches when individual wheel control is activated.

ⓘ NOTE Risk of damage due to the vehicle moving up and down

The vehicle can be lowered or raised on one or more wheels when the individual wheel control function has been activated. Vehicle parts could be damaged due to contact with objects.

- ▶ Make sure that the vehicle has sufficient room to move when the individual wheel control function has been activated.

Individual wheel control is a function of the suspension, which can be used to set the vehicle level for each wheel individually. This can help to improve alignment of the body when driving off-road.

You can activate individual wheel control via Off-road Assist (→ page 279).

Adjusting the vehicle level (vehicles with E-ACTIVE BODY CONTROL)

⚠ WARNING Risk of accident because vehicle level is too high

Driving characteristics may be impaired.

The vehicle can drift outwards, for example, when steering or cornering.

- ▶ Choose a vehicle level which is suited to the driving style and the road surface conditions.

⚠ WARNING Risk of entrapment from vehicle lowering

When lowering the vehicle, people could become trapped if their limbs are between the vehicle body and the tires or underneath the vehicle.

- ▶ Make sure no one is underneath the vehicle or in the immediate vicinity of the wheel arches when the vehicle is being lowered.

⚠ WARNING Risk of becoming trapped due to the vehicle lowering

Vehicles with AIRMATIC or level control: when you unload luggage or leave the vehicle, the vehicle first rises slightly and then returns to the set level shortly afterwards.

You or anyone else in the vicinity of the wheel arches or the underbody could thus become trapped.

The vehicle can also be lowered after being locked.

- ▶ When leaving the vehicle, make sure that nobody is in the vicinity of the wheel arches or the underbody.

! NOTE Damage due to vehicle lowering

Parts of the body could be damaged when the vehicle is lowered.

- ▶ Make sure that there are no obstacles such as curbs underneath or in the immediate vicinity of the body when the vehicle is being lowered.

Requirements

- The vehicle has been started.
- **Vehicles without Off-road package:**
 - The vehicle is not moving faster than 37 mph (60 km/h).
- **Vehicles with Off-road package:**
 - Off-road level +1: the vehicle is not moving faster than 56 mph (90 km/h).
 - Off-road level +2: the vehicle is not moving faster than 37 mph (60 km/h) in .

- Off-road level +3: the vehicle is not moving faster than 12 mph (20 km/h) in  and the rear fog lamp is not switched on.

- **When operating with a trailer or bicycle rack and the trailer socket is correctly contacted:**

- The vehicle is being driven no faster than 19 mph (30 km/h).
- ① Use the normal level in trailer operation. High-level driving is not permitted in trailer operation on public roads.

Raising the vehicle (vehicles without Off-road package)

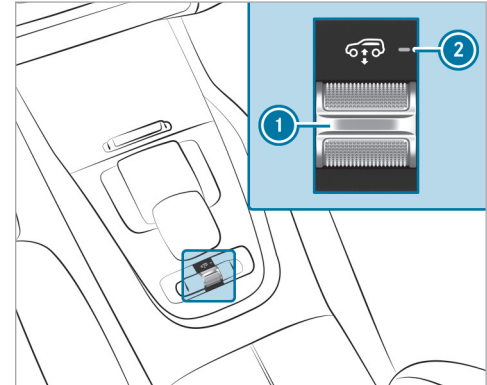

- ▶ Push rocker switch ① forwards. Indicator lamp ② flashes while the vehicle is being raised to off-road level +1 and lights up continuously when the raising process is complete.

Off-road level +1 set remains stored even after the vehicle has been switched off.

The vehicle is lowered again to the vehicle level of the selected drive program in the following situations:

- When driving faster than 50 mph (80 km/h).
- When driving briefly between 40 mph (65 km/h) and 50 mph (80 km/h).
- You select a different drive program.

Lowering the vehicle (vehicles without Off-road package)

- ▶ Pull rocker switch ①.
The vehicle is lowered to the height of the currently selected drive program. Indicator lamp ② flashes while the vehicle is being lowered and goes out when the lowering process is complete.

Raising the vehicle (vehicles with Off-road package)

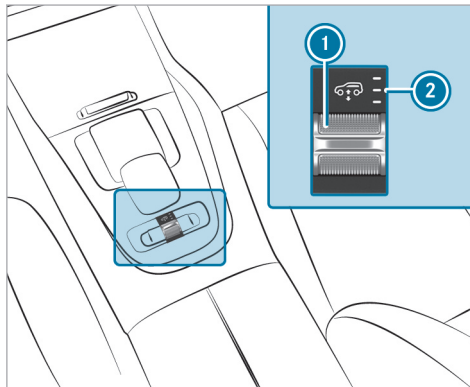

- ▶ Push rocker switch ① forwards.
The vehicle rises to the next higher vehicle level.

Following indicator lamps ② flash while the vehicle is being raised and light up continuously when the raising process is complete.

- Off-road level +1: one indicator lamp
- Off-road level +2: two indicator lamps
- Off-road level +3: three indicator lamps

The off-road level set remains stored even after the vehicle has been switched off.

In the following situations, the vehicle is lowered to the next lower vehicle level:

- In off-road level +3:
 - When driving faster than 12 mph (20 km/h).
 - You switch on the rear fog lamps.
- In off-road level +2:
 - When driving faster than 50 mph (80 km/h).
 - When driving briefly between 40 mph (65 km/h) and 50 mph (80 km/h).
- In off-road level +1:

- When driving faster than 68 mph (110 km/h).
- When driving briefly between 62 mph (100 km/h) and 68 mph (110 km/h).

i If you select a different drive program, the vehicle is lowered to the vehicle level of the selected drive program.

Lowering the vehicle (vehicles with Off-road package)

▶ Pull rocker switch **1**.

The vehicle is lowered to the next lower vehicle level. Indicator lamps **2** of the currently selected off-road gear flash while the vehicle is being lowered.

Following indicator lamps **2** light up continuously when the lowering process is complete.

- Off-road level +2: two indicator lamps
- Off-road level +1: one indicator lamp
- Normal level: no indicator lamp

The vehicle level set remains stored even after the vehicle has been switched off.

Setting Off-road Assist

Requirements

- the vehicle is stationary
- the off-road level is set
- off-road drive program  is selected
- the vehicle is switched on
- all doors and the hood are closed
- the transmission is not engaged in position **P**
- there is no trailer coupled
- the vehicle is outdoors
- the detected lateral inclination of the vehicle must not exceed approx. 15°
- the system is within its operating temperature
- the on-board voltage is sufficiently high

Multimedia system:

  ▶▶ Offroad ▶▶ Assistance

Recovery mode

Recovery mode assists the driver when pulling away on rough terrain, such as sand or snow.

▶ Select **Recovery Mode**.

▶ Select **Start**.

Recovery mode is activated.

▶ Select **Stop** to stop recovery mode.

Recovery mode is automatically deactivated in the following situations:

- you are actually traveling faster than 9 mph (15 km/h)
- after a running time of 30 seconds
- it is detected that an object has hit the underbody of the vehicle hard
- not all conditions are met

i Further information on recovery mode (→ page 275).

Individual wheel control

Individual wheel control enables the vehicle level to be set separately for each wheel.

▶ Select **Individual Wheel Ctrl.**

▶ Set the vehicle level for the desired wheel.

i You can also use the touchscreen to set the level for two or more wheels at the same time.

- ▶ Select **Reset** to set all wheels to the default setting.

Individual wheel control is automatically deactivated in the following situations:

- you are traveling faster than 9 mph (15 km/h)
 - it is detected that an object has hit the underbody of the vehicle hard
 - not all conditions are met
- i** Further information on individual wheel control (→ page 276).

Rear view camera

Function of the rear view camera

The rear view camera is only an aid. It is not a substitute for your attention to the surroundings. Responsibility for safe maneuvering and parking remains with you. Make sure that there are no persons, animals, objects, etc. in the maneuvering area while maneuvering and parking.

- i** The area behind the vehicle is displayed as a mirror image, as in the inside rear view mirror.

Vehicles with Parking Package

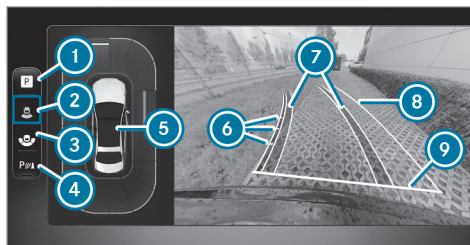

Camera Views menu in the 11.9" central display (top view)

- 1** Parking Assistance menu
- 2** Rear view camera with top view
- 3** Wide-angle view
- 4** Activating/deactivating Parking Assist PARKTRONIC (→ page 290)
- 5** Warning display of Parking Assist PARKTRONIC (→ page 287, 298)
- 6** Guide lines at a distance of approximately 1.6 ft (0.5 m), 3.3 ft (1.0 m), 5 ft (1.5 m) and 9.9 ft (3.0 m) from the rear area

- 7** Lane marking the course the tires will take with the current steering angle (dynamic)
 - 8** Driven surface depending on the current steering angle (dynamic)
 - 9** Guide line at a distance of approximately 1.0 ft (0.3 m) from the rear area
- i** When Active Parking Assist is active, lanes **7** are displayed in green (→ page 291).

System limits

If the system is not ready for operation, the **System Inoperative** message appears in the central display.

The rear view camera will not function or will function only partially in the following situations:

- You are driving forwards at a speed greater than approximately 10 mph (16 km/h).
- The tailgate is open.
- The weather conditions are poor, e.g. heavy rain, snow, fog, storm or spray.
- The ambient light is poor, e.g. at night or if light is shining into the camera.

- The camera lens is obstructed, dirty or fogged up. Observe the notes on cleaning the rear view camera (→ page 383).
- The camera or rear of your vehicle is damaged. In this case, have the camera and its position and setting checked at a qualified specialist workshop.
- The detection range is limited by additional vehicle attachments at the rear, such as a license plate bracket or bicycle rack.

Also observe the information on vehicle sensors and cameras (→ page 228).

- i** Do not use the rear view camera in these types of situations. You could otherwise injure others or collide with objects when parking the vehicle.
- i** The contrast of the display may be impaired by direct sunlight or by other light sources, e.g. when driving out of a garage. In this case, pay particular attention.
- i** Have the display repaired or replaced if, for example, pixel errors considerably restrict its use.

360° camera

Function of the 360° Camera

The 360° Camera is a system that consists of four cameras which cover the immediate surroundings of the vehicle. The cameras assist you when you are parking, for example, or at exits with reduced visibility.

The 360° Camera includes the following cameras and evaluates their images:

- Rear view camera
- Front camera
- Two side cameras in the outside mirrors

The cameras are only an aid and may show a distorted view of obstacles, show them incorrectly or not show them at all. They are not a substitute for your attention to the surroundings. Responsibility for safe maneuvering and parking remains with you. Make sure that there are no persons, animals, objects, etc. in the maneuvering area while maneuvering and parking.

Menu overview **Camera Views**



- 1** Parking Assistance menu
- 2** Top view with image from the front camera
- 3** Panorama view
- 4** Top view with image from the rear view camera
- 5** 3D view, left-hand side of the vehicle
- 6** 3D view, right-hand side of the vehicle
- 7** 3D auto view
- 8** Trailer view (equipment-dependent)
- 9** Activating/deactivating Parking Assist PARKTRONIC (→ page 290)
- 10** To set the GPS activation point

- ① In all views, the Parking Assist PARKTRONIC warning display is shown (→ page 287).

Function of the guide lines

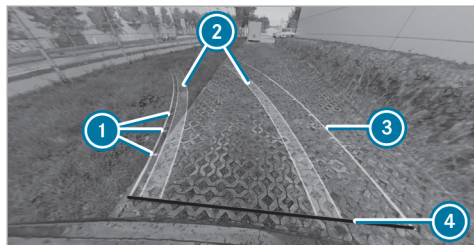

- ① Guide lines at a distance of approximately 1.6 ft (0.5 m), 3.3 ft (1.0 m), 5 ft (1.5 m) and 9.9 ft (3.0 m) from the rear area
- ② Lane marking the course the tires will take with the current steering angle (dynamic)
- ③ Driven surface depending on the current steering angle (dynamic)
- ④ Guide line at a distance of approximately 1.0 ft (0.3 m) from the rear area

- ① When Active Parking Assist is active, lanes and guide lines are displayed in green instead of yellow (→ page 291).

Top view with image from the front or rear view camera

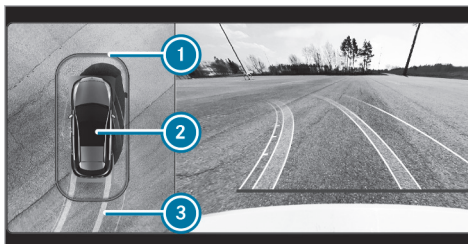

- ① Warning display of Parking Assist PARKTRONIC (→ page 287)
- ② Your vehicle from above
- ③ Lane indicating the route the vehicle will take at the current steering angle

3D view, left-/right-hand side of the vehicle

! **NOTE** Risk of accident due to objects being severely distorted in the display or not displayed at all

Due to the projection of the cameras, objects in the 3D views may be severely distorted when displayed or not displayed at all.

▶ Make sure that there are no persons, animals or objects etc. in the maneuvering area while maneuvering and parking.



In the 3D view, left-/right-hand side of the vehicle, the virtual camera moves to the respective

side of the vehicle ②. When you change the transmission position, the view is automatically adapted. In addition, top view ① is displayed with the Parking Assist PARKTRONIC warning display.

3D auto view

- ① The area behind the vehicle is **not** displayed as a mirror image as is usual in the 3D views.

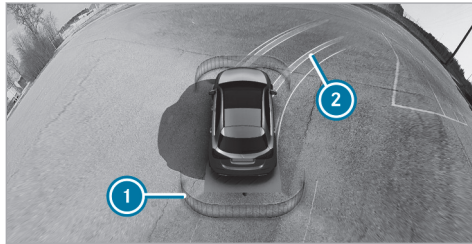

- ① Display of Parking Assist PARKTRONIC (→ page 287)
- ② Guide lines

In the 3D auto view, the virtual camera moves to the standard perspective, facing forward from the

rear above the roof. The view changes automatically when approaching obstacles.

If you touch the touchscreen, the view changes to 3D view with free rotation. You can turn, tilt and zoom the views by touch.

Wide-angle view



- ① Display of Parking Assist PARKTRONIC (→ page 287)
- ② Top view with image from the rear view camera
- ③ Wide-angle view

If the top view with image from the rear camera is displayed, switch to the wide-angle view with icon

② indented to the left. When the wide-angle view is displayed, switch back to the respective top view.

Trailer view

- ① In trailer mode, the guide lines are shown at the level of the trailer hitch.

If you select trailer view and no trailer is coupled to the vehicle, the following display appears:

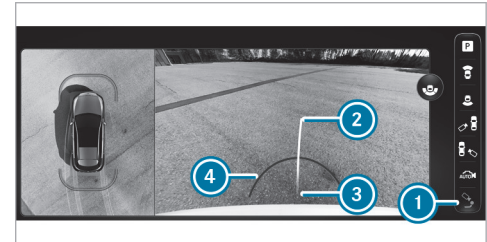

Trailer view: locating aid

- ① To switch between standard and trailer view
- ② Yellow locating aid

- ③ Ball head of the trailer hitch
- ④ Red guide line at a distance of approximately 1.0 ft (0.3 m) from the ball head of the trailer hitch

When the electrical connection is established between the vehicle and the trailer, the display changes to the side camera view.

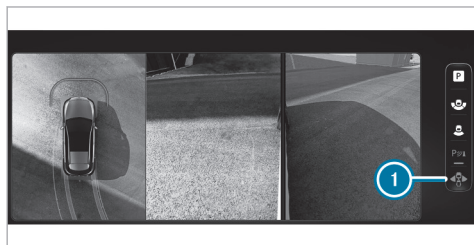

Trailer view: side view of the mirror cameras

- ① To switch between standard and trailer view

System limits

If the system is not ready for operation, the **System Inoperative** message appears in the central display.

The 360° Camera will not function or will only partially function in the following situations:

- You are driving forwards at a speed greater than approximately 10 mph (16 km/h).
- The doors are open.
- An outside mirror is not completely folded out.
- The tailgate is open.
- The weather conditions are poor, e.g. heavy rain, snow, fog, storm or spray.
- The ambient light is poor, e.g. at night or if light is shining into the camera.
- The camera lens is obstructed, dirty or fogged up.
- If cameras or vehicle components in which the cameras are installed are damaged. In this event, have the cameras, their positions and their setting checked at a qualified specialist workshop.

- ① Do not use the 360° Camera under such circumstances. You could otherwise injure others or collide with objects when parking the vehicle.

For technical reasons, the standard height of the vehicle may be altered if the vehicle is carrying a heavy load and can result in inaccuracies in the guide lines and in the display of the generated images.

The field of vision and other functions of the camera system may be restricted due to additional attachments on the vehicle (e.g. license plate bracket, bicycle rack).

- ① The contrast of the display may be impaired by abrupt, direct sunlight or by other light sources, e.g. when driving out of a garage. In this case, pay particular attention.
- ① Have the display repaired or replaced if, for example, pixel errors considerably restrict its use.

See the notes on cleaning the 360° Camera (→ page 383).

Off-road function of the 360° camera

The 360° camera can support you with different views when driving off-road.

The following views are available:

- Transparent hood

- Front view
- Rear view

To call up the function, call up the off-road menu in the multimedia system (→ page 338).

- ① Active Parking Assist and the maneuvering assistant functions are not available in drive program . PARKTRONIC Parking Assist is available in all driving programs when it is switched on. Please also note the system limits of the respective functions.

Transparent hood

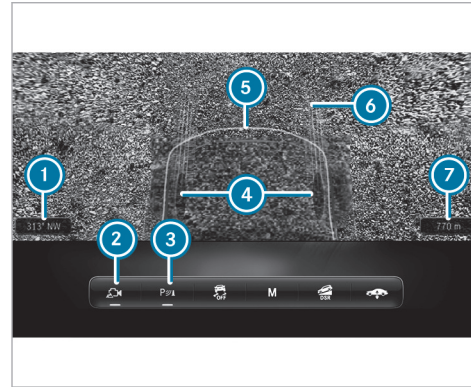

Transparent hood displays (example)

- ① Point of the compass
- ② Switch camera view on/off
- ③ Activating/deactivating PARKTRONIC (→ page 287)
- ④ Position of the wheels
- ⑤ Area under the hood

- ⑥ Lane indicating the route the vehicle will take at the current steering angle
- ⑦ Altitude above sea level

If the off-road menu is open in the central display and the button ② is switched on, the Transparent hood view is automatically displayed in gearbox position .

The Transparent hood view shows a virtual image of the area directly in front of the bumper, in front of the tires and under the hood. In addition, the current lane is displayed. The Transparent hood can assist you when driving in difficult terrain, e.g. on rocky or uneven ground.

The hatched area under the hood ⑤ was captured and recorded by the front camera. As soon as the area has been crossed by the vehicle, it is faded in. If the vehicle has not been moved for some time, the recorded area is displayed in gray-scale and faded out.

Front and rear view

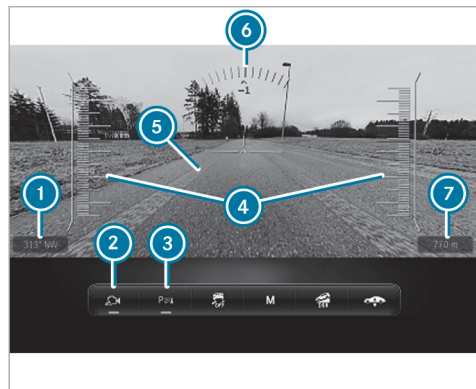

Display of front and rear view (example)

- ① Point of the compass
- ② Switch camera view on/off
- ③ Activating/deactivating PARKTRONIC (→ page 287)
- ④ Pitch display

- ⑤ Lane indicating the route the vehicle will take at the current steering angle
- ⑥ Roll display
- ⑦ Altitude above sea level

- ⓘ Note that the area between the vehicle and up to approx. 40 in (1 m) in front of the vehicle is not displayed.
The slope and inclination indicators are shown only in the front view.

If the vehicle is traveling faster than approx. 5 mph (8 km/h) the view automatically changes from Transparent hood to Front View. If the vehicle is traveling at a speed greater than approximately 12 mph (20 km/h) - 19 mph (30 km/h) (depending on the drive program), the camera image will be closed.

When you engage reverse gear, the image from the rear view camera is automatically displayed.

System limits

The area under the hood may not be displayed correctly in the following situations:

- in the rain

- Driving in the dark
- When shadows fall on the area recorded by the camera

Observe the instructions on the function of the 360° camera as well as its system limits, otherwise you will not be able to recognize dangers (→ page 281).

■ Calling up the 360° camera views using the button

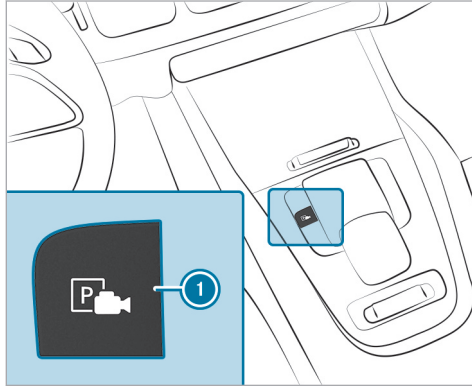

- ▶ Press button ①.
- ▶ Select the **Camera Views** menu.
- ▶ Select the desired view in the multimedia system (→ page 281).

■ Selecting a view for the 360° camera (reverse gear)

- ▶ Engage reverse gear.
- ▶ Select the desired view in the multimedia system (→ page 281).

■ Opening the camera cover

Multimedia system:

→ ▶ Settings ▶ Assistance

▶▶ Camera

- ▶ Select **Open Camera Cover**.

- ① The camera cover closes automatically after some time or after the vehicle is switched on or off.

Parking Assist PARKTRONIC

■ Function of Parking Assist PARKTRONIC

Parking Assist PARKTRONIC is an electronic parking assistance system which monitors the area surrounding your vehicle and shows you the distance between the vehicle and a detected obstacle visually and audibly.

Parking Assist PARKTRONIC is only an aid. It is not a substitute for your attention to the surroundings. Responsibility for safe maneuvering and parking remains with you. Make sure that there are no persons, animals, objects, etc. in the maneuvering area while maneuvering and parking in/exiting parking spaces.

The passive side impact protection also warns you of obstacles to the side. During the parking procedure or maneuvering, objects are detected as the vehicle drives past. If you steer in the direction of a detected obstacle and there is a risk of a lateral collision, a warning is issued. In order for an object on the side to be detected, the sensors in the front and rear bumper must first detect the object while you are driving past it.

In order for front or rear obstacles to the side to be displayed, the vehicle must first travel a distance of at least half a vehicle length. Once the vehicle has traveled one vehicle length, obstacles on all sides can be shown.

Displays in the driver's display

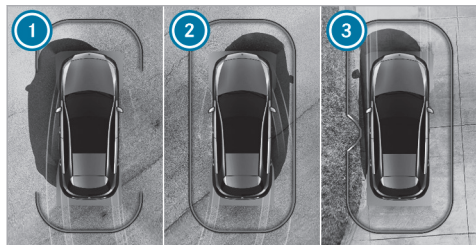

Vehicles with 360° Camera

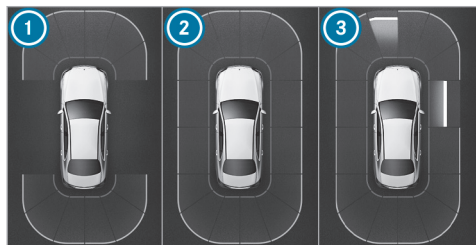

Vehicles without 360° Camera

As soon as Parking Assist PARKTRONIC is ready for display, the respective areas of the display are shown in blue.

- ① Front and rear ready for display
- ② All sides ready for display
- ③ Obstacles detected at the front left and on the right-hand side

The color of the display changes depending on the distance to the detected obstacle:

- **Blue:** > 3.3 ft (1 m) (no obstacles detected)
- **Yellow:** approximately 3.3 ft (1 m) - 2.3 ft (0.7 m)
- **Orange:** approximately 2.3 ft (0.7 m) - 1.2 ft (0.4 m)
- **Red:** < 1.2 ft (0.4 m)

Vehicles with 360° Camera: the boundary line shifts dynamically depending on the position and distance of the obstacles detected.

Depending on the distance to the obstacle detected, an intermittent warning tone also sounds. You can set the timing of the warnings in the multimedia system (→ page 290)

Standard setting:

- **Front and sides:** < 1.2 ft (0.4 m)
- **Rear:** < 3.3 ft (1 m)

Warn Early All Around:

- **Front:** < 3.3 ft (1 m)
- **Sides:** < 2.3 ft (0.7 m)
- **Rear:** < 3.3 ft (1 m)

A continuous warning tone sounds from a distance of approximately 0.7 ft (0.2 m), regardless of the selected setting.



Vehicles with 360° Camera

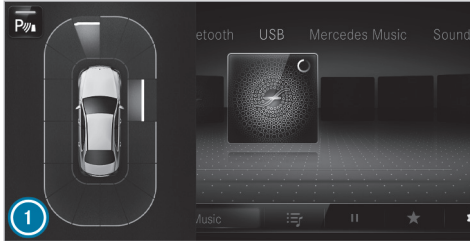

Vehicles without 360° Camera

If an obstacle is detected in the travel path and the menu **Camera & Parking** is not open in the driver display, the pop-up window appears **1**:

- **vehicles without Active Parking Assist:** at speeds below 8 mph (12 km/h)
- **vehicles with Active Parking Assist:** at speeds below 11 mph (18 km/h)

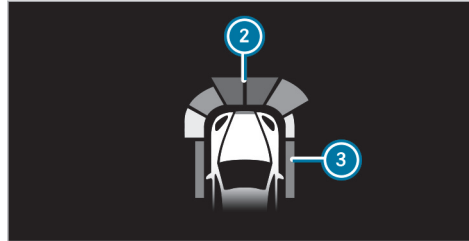

Optionally, obstacles detected by Parking Assist PARKTRONIC from a distance of approximately 3.3 ft (1.0 m) in front **2** and 2.3 ft (0.7 m) on the side **3** can also be displayed in the head-up display.

System limits

Parking Assist PARKTRONIC does not necessarily take into account the following obstacles:

- Obstacles below the detection range, e.g. persons, animals or objects.
- Obstacles above the detection range, e.g. overhanging loads, overhangs or loading ramps of trucks.

- Pedestrians or animals approaching the vehicle from the side.
- Objects placed next to the vehicle

Obstacles on the sides are not shown in the following situations, for example:

- You park the vehicle and switch it off.
- You open the doors.

After an engine start, obstacles must be detected again by driving past them before a warning can be issued.

Observe the information on vehicle sensors and cameras; the system otherwise cannot function properly (→ page 228).

Vehicles with trailer hitch: Parking Assist PARKTRONIC is deactivated for the rear zone when you establish an electrical connection between your vehicle and a trailer.

Problems with Parking Assist PARKTRONIC

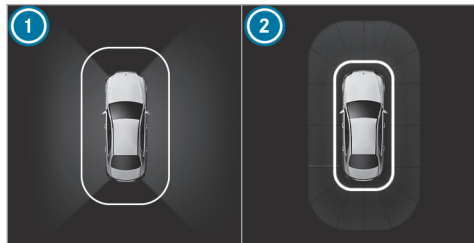

- ① Vehicles with 360° Camera
- ② Vehicles without 360° Camera

If the Parking Assist PARKTRONIC display lights up red for approximately three seconds then goes out, and the  symbol appears, the system may have been deactivated due to signal interference. Start the vehicle again and check if Parking Assist PARKTRONIC is working at a different location.

If the  symbol appears and a warning tone sounds, it may be due to one of the following causes:

- **The sensors are dirty:** clean the sensors and observe the notes on care of vehicle parts (→ page 383).
- **Parking Assist PARKTRONIC has been deactivated due to a malfunction:** restart the vehicle. If the problem persists, consult a qualified specialist workshop.

■ Activating/deactivating Parking Assist PARKTRONIC

! **NOTE** Risk of an accident from objects at close range

Parking Assist PARKTRONIC may not detect certain objects at close range.

- ▶ When parking or maneuvering the vehicle, pay particular attention to any objects which are above or below the sensors, e.g. flower pots or drawbars. The vehicle or other objects could otherwise be damaged.

Requirements:

- The camera menu is open.
- Or: Active Parking Assist is active.
- Or: the PARKTRONIC pop-up window appears.

▶ Press  in the central display.

If the indicator lamp is lit, Parking Assist PARKTRONIC is active. If the indicator lamp does not light up or the symbol  is displayed, PARKTRONIC Parking Assist is not active.

① Parking Assist PARKTRONIC is automatically activated when the vehicle is started.

Alternatively, Parking Assist PARKTRONIC can be activated or deactivated in the quick access menu.

■ Setting the warning tones of Parking Assist PARKTRONIC

Multimedia system:

▶  ▶ **Settings** ▶ **Assistance**
▶ **Parking**

Adjusting warning tones

▶ Select **Set Warning Tones**.

- ▶ Set the desired level under **Volume** or **Tone Pitch**.

Activating/deactivating audio fadeout

- ▶ **Audio Fadeout** select and **Audio Fade for Warnings** switch on or off.
The volume of the currently playing media source is reduced during a Parking Assist PARKTRONIC warning tone.

or

- ▶ **Audio Fadeout** select and **Audio Fadeout When in R** switch on or off.
The volume of the currently playing media source is reduced when reverse gear is engaged.

Setting the time of the warnings

- ▶ Select **Time of Warning**.
- ▶ Activate or deactivate **Side Warning**.
- ▶ Set the desired warning time for **Front** or **Rear**.

Active Parking Assist

Function of Active Parking Assist

Active Parking Assist is an electronic parking assistance system, which uses ultrasound with the assistance of the rear view camera and 360° camera. When you are driving forwards at up to approximately 22 mph (35 km/h), the system automatically measures parking spaces on both sides of the vehicle.

Active Parking Assist offers the following functions:

Vehicles with rear view camera

- Parking in parking spaces parallel to the road

Vehicles with 360° camera

- Parking in parking spaces parallel to the road
- Parking in parking spaces perpendicular to the road (optionally either forwards or reverse)
- Parking in parking spaces that can only be detected as such due to markings (e.g. at the roadside)
- Exiting parking spaces if you have parked using Active Parking Assist

As soon as all requirements are met for searching for parking spaces, the  display appears on the driver's display.

When Active Parking Assist has detected parking spaces, the  display appears on the driver's display. The arrows show on which side of the road detected parking spaces are located. They are then shown on the central display.

Vehicles with rear view camera: the parking space can be selected as desired. The vehicle is parked in reverse.

Vehicles with 360° camera: the parking space can be selected as desired. Depending on the location of the parking space, the parking direction (forwards or reverse) can also be selected as desired.

When Active Parking Assist is activated, the turn signal indicators are activated based on the calculated path of your vehicle.

The parking procedure is supported by accelerating, braking, steering and gear changes.

Active Parking Assist is only an aid. It is not a substitute for your attention to the surroundings. The responsibility for safe maneuvering and parking

remains with you. Make sure that no persons, animals or objects etc. are in the maneuvering range.

Active Parking Assist will be canceled in the following situations:

- You begin steering.
- You apply the electric parking brake.
- You engage park position **P**.
- ESP® intervenes.
- You open the doors or the tailgate while driving.

System limits

If the exterior lighting is faulty, Active Parking Assist may not function, depending on the defect.

Also observe the system limits of the following systems:

- Rear view camera (→ page 280)
- 360° camera (→ page 281)

Objects located above or below the detection range of the sensors, e.g. overhanging loads, overhangs or loading ramps of goods vehicles, or the borders of parking spaces, are not detected

during measurement of the parking space. They are then not taken into account when calculating the parking procedure either. In some circumstances, Active Parking Assist may therefore guide you into the parking space incorrectly.

⚠ WARNING Risk of accident due to objects located above or below the detection range of Active Parking Assist

If there are objects above or below the detection range, the following situations may arise:

- Active Parking Assist may steer too early.
- The vehicle may not stop in front of these objects.

There is a danger of collision!

▶ In these situations, do not use Active Parking Assist.

Extreme weather conditions, such as snow or heavy rain, may lead to a parking space being measured inaccurately. Parking spaces that are partially occupied by trailer drawbars might not be identified as such or may be measured incor-

rectly. Only use Active Parking Assist on level, high-grip ground.

Do not use Active Parking Assist in the following situations:

- In extreme weather conditions, e.g. when there is ice or packed snow, or in heavy rain.
- When transporting a load that protrudes beyond the vehicle.
- On steep uphill or downhill gradients of more than approximately 15%.
- When snow chains are installed.
- When a trailer or bicycle rack is attached.
- Directly after a tire change or when spare tires are installed.
- If the tire pressure is too low or too high.
- If the suspension is out of alignment, e.g. after you have bottomed out on a curb.

Active Parking Assist may also display parking spaces that are not suitable for parking, such as:

- Parking spaces where parking is prohibited.
- Parking spaces on unsuitable surfaces.

Parking with Active Parking Assist

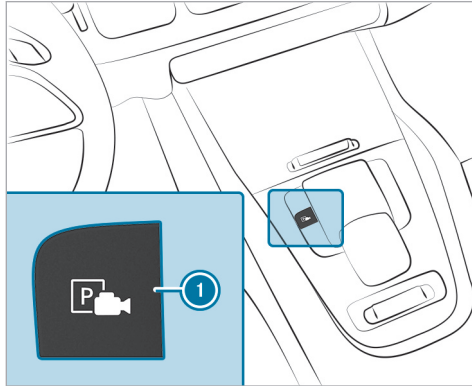

i Depending on the vehicle's equipment, button **1** may also be located in a different position on the center console.

▶ Press button **1**.

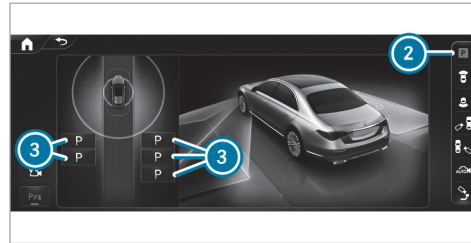

Parking assistance menu (example)

▶ Select **Parking Assistance** menu **2**.

Parking spaces **3** detected by the system are shown on the central display.



Parking assistance menu (example)

When the vehicle is stationary, indicated vehicle path **4** into currently selected parking space **5** also appears.

▶ If a parking space is displayed: stop the vehicle.

▶ If necessary, select another parking space.

▶ **Vehicles with 360° camera:** to change the parking direction, tap the selected parking space again.

- ▶ **To start the parking procedure:** press button ❶ again.
The vehicle drives into the selected parking space.

The turn signal indicator is switched on automatically when the parking procedure begins. You are responsible for selecting the turn signal indicator in accordance with the traffic conditions. If necessary, select the turn signal indicator accordingly.

⚠ WARNING Risk of accident due to vehicle swinging out while parking or pulling out of a parking space

While parking or exiting a parking space, the vehicle swings out and can drive onto areas of the oncoming lane.

This could cause you to collide with objects or other road users.

- ▶ Pay attention to objects and other road users.
- ▶ Where necessary, stop the vehicle or cancel the parking procedure with Active Parking Assist.

On completion of the parking procedure, the **Active Parking Assist Finished** display message appears.

- ▶ Secure the vehicle against rolling away. When required by legal stipulations or local conditions: turn the wheels toward the curb.
- ❶ You can stop the vehicle and change the transmission position during the parking procedure. The system then calculates a new vehicle path. If no new vehicle path is available, the transmission position can be changed again, or the process can be canceled.

■ Exiting a parking space with Active Parking Assist

Requirements

- The vehicle has been parked with Active Parking Assist.
- ▶ Start the vehicle.
- ▶ Press button ❶.



Parking assistance menu (example)

- ▶ Select **Parking Assistance** menu ❷.
- ▶ If necessary, change direction of exit ❸.
- ▶ **To start exiting the parking space:** press button ❶ again.
- ▶ If necessary, change the transmission position. Observe any messages shown on the driver's display and central display.
The vehicle moves out of the parking space.

The turn signal indicator is automatically switched on when the procedure for exiting the parking space begins and switched off when it is completed. You are responsible for selecting the turn sig-

nal indicator in accordance with the traffic conditions. If necessary, select the turn signal indicator accordingly.

After the procedure for exiting the parking space has been completed, a warning tone and the  **Active Parking Assist Finished: Take Control of Vehicle** message prompt you to take control of the vehicle. You have to accelerate, brake, steer and change gear yourself again.

If you do not react to the prompt to take control of the vehicle, the system will brake the vehicle to a standstill.

■ Pausing Active Parking Assist

You can interrupt the parking or exiting procedure of Active Parking Assist by performing one of the following actions, forexample:

- ▶ Depress the brake pedal.
- ▶ Open the front passenger door, a rear door, the tailgate or the hood.
- ▶ Apply the electric parking brake or activate the HOLD function.
- ▶ **To resume the parking or exiting procedure:** gently depress the accelerator pedal.

- ① If the electric parking brake was applied before Active Parking Assist was activated, depress the accelerator pedal lightly to start the parking or exiting procedure.

Check the area around your vehicle again before resuming a paused parking procedure. Make sure once more that there are no persons, animals or objects in the vehicle's path. Also observe the system limitations of Active Parking Assist.

■ Automatic braking function of Active Parking Assist

Persons or objects detected in the maneuvering range could cause the vehicle to brake sharply and interrupt the parking or exiting procedure. The vehicle will then be held at a standstill. If you depress the accelerator pedal, the parking or exiting procedure is resumed.

Check the area around your vehicle again before resuming the parking or exiting procedure. Make sure once more that no persons, animals or objects are in the maneuvering range. Also observe the system limitations of Active Parking Assist.

Maneuvering assistance

■ Function of Drive Away Assist

Drive Away Assist can reduce the severity of an impact when you are pulling away. If an obstacle is detected in the direction of travel, the vehicle's speed is briefly reduced to approx. 1 mph (2 km/h). If a critical situation is detected, the  symbol appears on the central display.

Drive Away Assist can be deactivated or activated in the **Maneuvering Assistance** menu.

- ① You can cancel an intervention by Drive Away Assist at any time by deactivating Parking Assist PARKTRONIC.

 **WARNING** Risk of accident caused by limited detection performance of Drive Away Assist

Drive Away Assist cannot always clearly identify objects and traffic situations.

- ▶ Always pay careful attention to the traffic situation; do not rely on Drive Away Assist alone.

- ▶ Be prepared to brake or swerve as necessary, provided the traffic situation permits and that it is safe to take evasive action.

Drive Away Assist is only an aid. It is not a substitute for your attention to the surroundings. The responsibility for safe maneuvering and parking remains with you. Make sure that no persons, animals or objects etc. are in the maneuvering range.

A risk of collision may occur in the following situations, for example:

- If the driver mixes up the accelerator and brake pedals.
- If an incorrect transmission position is engaged.

Drive Away Assist is active under the following conditions:

- If Parking Assist PARKTRONIC is activated.
- If you shift the transmission position to **R** or **D** when the vehicle is stationary.

- If the detected obstacle is less than approx. 3.3 ft (1.0 m) away.
- If the maneuvering assistance function is activated in the multimedia system.

System limits

Drive Away assist is not available in the  drive program.

The performance of Drive Away Assist is limited on inclines.

When driving with a trailer, Drive Away Assist is not available.

- i** Also observe the system limits of Parking Assist PARKTRONIC (→ page 287).

Function of Cross Traffic Alert

- i** Cross Traffic Alert is only available for vehicles with Blind Spot Assist or Active Blind Spot Assist.

Cross Traffic Alert can warn drivers of any crossing traffic when backing up and maneuvering out of a parking space. The radar sensors in the bumper also monitor the area adjacent to the vehicle. If a critical situation is detected, the 

symbol appears on the central display and the vehicle can be braked automatically.

If the radar sensors are obstructed by vehicles or other objects, detection is not possible.

Cross Traffic Alert is active under the following conditions:

- The vehicle is backing up at walking pace.
- Maneuvering assistance is activated (→ page 297).
- i** Also observe the instructions on Blind Spot Assist and Active Blind Spot Assist (→ page 260).

System limits

Cross Traffic Alert is not available in the  drive program.

Cross Traffic Alert is not available on inclines.

Cross Traffic Alert is not available when driving with a trailer.

Close-range braking function

The close-range braking function can prevent collisions with pedestrians when the vehicle is backing up at slow speeds. If the rear view camera

detects a person in the vehicle path, the vehicle can be braked to a standstill.

The close-range braking function can intervene under the following conditions:

- The vehicle is backing up at a speed slower than 6 mph (10 km/h).
- The camera image is shown in the central display (→ page 287).

You can activate and deactivate the close-range braking function in the **Maneuvering Assistance** menu (→ page 297).

If the close-range braking function is triggered, the following symbol appears in red in the selected view in the **Camera & Parking** menu:



- ⓘ If the close-range braking function is not available, the same symbol appears in gray.

The close-range braking function is only an aid. It is not a substitute for your attention to the surroundings. The responsibility for safe maneuvering

and parking remains with you. Make sure that no persons, animals or objects etc. are in the maneuvering range.

⚠ WARNING Risk of accident caused by limited detection by the maneuvering brake function

The maneuvering brake function cannot always clearly detect people. Other obstacles are not detected by the function.

In these cases, the function may brake unnecessarily or not brake at all.

- ▶ Always pay careful attention to the traffic situation; do not rely on the maneuvering brake function alone.
- ▶ Be ready to brake.

System limits

In the driving program , the shunt braking is not available.

Observe the system limits of the following functions:

- Active Parking Assist (→ page 291)

- 360° camera (→ page 281)
- Rear view camera (→ page 280)

The close-range braking function is not available in the following situations:

- on inclines
- If transport equipment, for example a trailer or bicycle rack, is attached to the trailer hitch and the electrical connection has been correctly established.

■ Activating/deactivating maneuvering assistant

Multimedia system:

→  ▶ Settings ▶ Assistance
▶▶ Parking

- ⓘ This function is an on-demand feature (→ page 28).
- ⓘ Activating/deactivating the maneuvering assistant function is not available in all countries.
- ▶ Select **Maneuvering Assistance**.
- ▶ Activate or deactivate the desired maneuvering assistance.

Trailer Maneuvering Assist

Function of Trailer Maneuvering Assist

- ⓘ This function is an on-demand feature (→ page 28).

⚠ WARNING Risk of accident due to unsuitable trailers

Trailers with a steered axle or a fifth wheel cannot be used with Trailer Maneuvering Assist.

Due to this, the trailer cannot be maneuvered in the desired direction and you can cause a collision or the trailer can rollover.

- ▶ Only use Trailer Maneuvering Assist with trailers with fixed drawbars and axles.

⚠ WARNING Risk of accidents due to unsuitable hitching devices

Trailer hitches without a ball head, such as a Hensley hitch or a pintle hitch, as well as any hitch adapters or multiple hitch ball mounts, **cannot** be guided by Trailer Maneuvering Assist.

This will prevent the trailer from maneuvering in the desired direction and you may cause a collision or the trailer may roll over.

- ▶ Use Trailer Maneuvering Assist only with a trailer hitch with a ball head.
- ▶ Use Trailer Maneuvering Assist only with a trailer hitch without additional attachments, such as a weight distribution system or sway control.
- ▶ Use Trailer Maneuvering Assist only with a trailer with a drawbar that has no additional attachments or superstructures.
- ▶ Use Trailer Maneuvering Assist only with a hitch ball mount. The use of an additional hitch adapter or hitch ball mount is not permitted.

⚠ WARNING Danger of accident due to incorrect taught values for the ball head position

If after changing the trailer, ball neck or changing the ball head position the values for the ball head position are **not** reset and a cali-

bration drive is carried out again, Trailer Maneuvering Assist will not function properly.

This will prevent the trailer from maneuvering in the desired direction and you may cause a collision.

- ▶ After changing the trailer, the ball neck or the ball head position, do not use Trailer Maneuvering Assist without carrying out a calibration drive again.
- ▶ After changing the trailer, the ball neck or the ball head position, reset the taught-in values.
- ▶ Then, carry out a calibration drive to teach in the values of the new ball head position.

Information on resetting the taught-in values for the ball head position and on the calibration drive (→ page 305).

! **NOTE** Damage due to overhanging loads in front or drawbar installations

The vehicle and the trailer may be damaged during maneuvering due to overhanging loads at the front of the trailer or drawbar installations.

- ▶ Pay attention to overhanging loads or drawbar installations while maneuvering.

Trailer Maneuvering Assist will assist you when you are backing up with a trailer. Using the rear-view camera, it monitors the articulation angle between the vehicle and trailer and adjusts it to a specified value. Trailer Maneuvering Assist will also limit your speed.

For Trailer Maneuvering Assist to function properly, a calibration drive must be carried out for the trailer and ball neck used and if the ball head position is changed. The current ball head position will be taught in during the calibration drive (→ page 305).

Trailer Maneuvering Assist is only an aid. It is not a substitute for your attention to the surroundings. The responsibility for safe maneuvering and

parking remains with you. Make sure that there are no persons, animals or objects in the maneuvering area while you are maneuvering and parking in / exiting parking spaces.

You can either enter the articulation angle value directly via the multimedia system, or use a straightening maneuver or the 90° maneuver. When you carry out a straightening maneuver, the system will calculate the articulation angle automatically and align the vehicle/trailer combination with the trailer's current direction.

Observe the notes on trailer operation (→ page 301).

System limits

Observe the system limits of the following functions:

- Active Parking Assist (→ page 291)
- 360° camera (→ page 281)
- Rear-view camera (→ page 280)

The system may be impaired or may not function in the following situations:

- The gradient is greater than approximately 15%.
- The height of the ball head above level ground is less than 13.8 in (0.35 m) or more than 21.6 in (0.55 m)

■ Using Trailer Maneuvering Assist

Requirements

- The vehicle has been started and is stationary.
- A trailer has been detected.
- A calibration drive was performed with the ball neck used and the current ball head position (→ page 305).
- The gradient is less than approximately 15 %.
- The tailgate is closed.
- The electric parking brake is not applied.
- The driver's seat belt is fastened.

Using Trailer Maneuvering Assist

- i** To ensure that Trailer Maneuvering Assist works properly, the taught-in values for each ball head position must be reset after the ball neck and ball head position have been changed. A calibration drive must then be performed again. Information on resetting and the calibration drive (→ page 305).

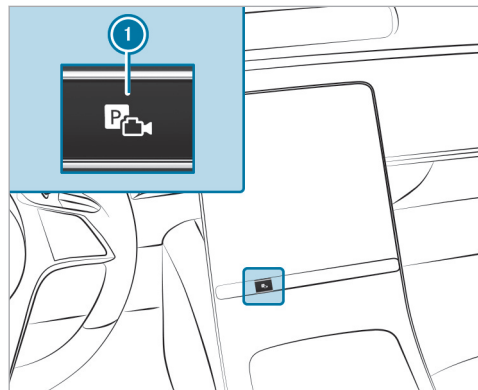

- ▶ Engage reverse gear **R**.
- ▶ Press button **1**.
The camera image is shown in the central display.

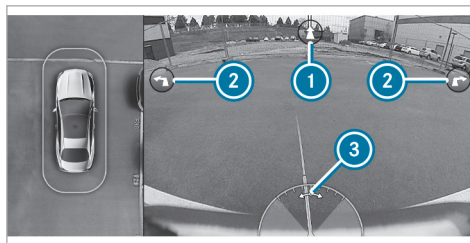

- i** The picture is an example only and is shown without trailer.

You can select various maneuvers in the Trailer Maneuvering Assist menu. The maneuver available depends on the current articulation angle and length of the trailer.

- ▶ To adjust the articulation angle: select **3**. In the central display, swipe the entire area of

the camera image to the left or right to change the bend angle.

or

- ▶ To activate the straightening maneuver: select **1**.

The system calculates the articulation angle in such a way that the direction of the trailer at the time of activation is maintained. There is a short countersteering movement of the trailer while the vehicle is backing up, which then guides it back to the desired line. In this way, the vehicle is aligned straight with the trailer and, at the same time, the direction of the trailer is maintained.

or

- ▶ To activate the 90° maneuver:
 - Align the vehicle in the same direction (line) as the trailer.
 - Select (left or right) **2**.

The system calculates the articulation angle so that the trailer can be maneuvered into a space perpendicular to the vehicle using the smallest possible angle. After the maneuver,

the vehicle is aligned again in the direction of the trailer.

▶ Accelerate and brake as required.

ⓘ The maximum articulation angle depends on the length of the trailer. This is calculated by the system by driving the vehicle forwards, including cornering. Before the length of the trailer has been calculated, the maximum articulation angle is approximately 23°. The longer the trailer is, the higher the maximum articulation angle (max. approximately 60°).

ⓘ Pay attention to your surroundings and be ready to brake at all times.

Trailer hitch

Notes on trailer operation

! **NOTE** Mercedes-AMG vehicles

▶ Observe the notes in the Supplement. You could otherwise fail to recognize dangers.

! **WARNING** Risk of accident due to unsuitable ball neck

If you install an unsuitable ball neck, the trailer hitch and the rear axle may be overloaded.

This can significantly impair the driving characteristics and the trailer may become loose. There is a risk of fatal injury.

- ▶ Only install a ball neck that complies with the permissible dimensions and is designed for the requirements of trailer operation.
- ▶ Do not modify the ball neck or the trailer hitch.

The values approved by the manufacturer can be found on the identification plates and in the "Technical data" section under "Trailer hitch" for the towing vehicle (→ page 465).

! **WARNING** Risk of accident due to vehicle/trailer combination swerving

If you drive too fast in trailer operation, the vehicle/trailer combination may start to swerve.

This could cause you to lose control of the vehicle/trailer combination. The vehicle/trailer combination may even rollover.

- ▶ Under no circumstances should you try to straighten the vehicle/trailer combination by increasing your speed.
- ▶ Reduce the speed and do not countersteer.
- ▶ Brake if necessary.

! **NOTE** Damage to the engine resulting from overheating

▶ If you subsequently have a trailer coupling retrofitted, depending on the vehicle type, changes to the engine cooling system may be required.

In the case of retrofitting a trailer coupling, please observe the attachment points on the vehicle frame.

Retrofitting a trailer hitch is permissible only if a trailer load is specified in your vehicle documents. If this is not the case, the vehicle is not approved for trailer operation.

Further information can be obtained at a qualified specialist workshop.

For a detachable trailer coupling, it is essential to comply with the operating instructions of the trailer coupling manufacturer.

Couple and uncouple the trailer carefully. If you do not connect the trailer to the towing vehicle correctly, the trailer may become detached.

Observe the following notes on the tongue weight:

- Do not use a tongue weight that exceeds or falls below the permissible tongue weight
- Use a tongue weight as close as possible to the maximum tongue weight

Do not exceed the following values:

- Permissible towing capacity
- Permissible rear axle load of the towing vehicle
- Permissible gross weight of the towing vehicle
- Permissible gross weight of the trailer
- Maximum permissible speed of the trailer

Ensure the following before starting a journey:

- The tire pressure on the rear axle of the towing vehicle is set for a maximum load
- The lighting of the connected trailer is operational

In the event of increased rear axle load, the car/trailer combination must not exceed a maximum speed of 62 mph (100 km/h) for reasons concerning the operating permit. This also applies in countries in which the permissible maximum speed for car/trailer combinations is above 62 mph (100 km/h).

Vehicles with AIRMATIC or E-ACTIVE BODY CONTROL: if the socket of the trailer hitch is occupied, e.g. by a trailer or rear bicycle rack, the vehicle is

set to the normal level at speeds greater than 19 mph (30 km/h). This is done regardless of which drive program has been selected.

Attaching the ball neck

⚠ WARNING Risk of accident and injury due to incorrectly installed ball neck

If the ball neck is not properly mounted and secured, it may come loose along with the trailer while the vehicle is in motion and endanger other road users. There is a risk of fatal injuries.

- ▶ Mount and secure the ball neck as described in the installation instructions of the ball neck manufacturer.
- ▶ With the ball neck mounted, always make sure it is properly secured before commencing a journey.

Attaching the ball neck

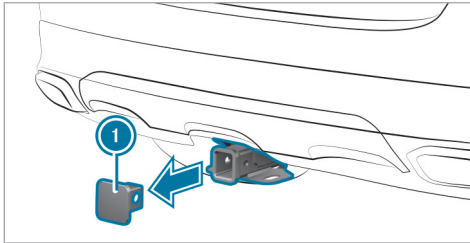

- ▶ Secure the vehicle against rolling away.
- ▶ Remove cover cap ❶ from the ball neck mount in the direction of the arrow.
- ▶ Store cover cap ❶ such that it cannot move around.
- ▶ Comply with the installation instructions of the ball neck manufacturer.

Observe the notes on loading the vehicle.

- ❶ To ensure that the Trailer Maneuvering Assist functions properly, the taught-in values for the ball head position must be reset after each change of trailer, ball neck, or ball head posi-

tion. A calibration drive must then be performed again. Information on resetting and the calibration drive (→ page 305).

Coupling up/uncoupling a trailer

⚠ WARNING Risk of injury due to a change in vehicle level

Vehicles with level control system: the vehicle level may be changed unintentionally, e.g. by other persons. If you couple or uncouple the trailer during this time, you may become trapped. In addition, other people could become trapped if their limbs are between the vehicle body and the tires or underneath the vehicle.

Observe the following when coupling or uncoupling:

- ▶ Do not open or close any doors or the tailgate.
- ▶ Do not initiate the level control system and do not operate DYNAMIC SELECT.
- ▶ Do not lock or unlock the vehicle.

The trailer will be correctly detected by the vehicle only if the following conditions are met:

- The trailer is connected correctly.
- The trailer lighting system is in working order.
- ❶ Before using Trailer Maneuvering Assist and after each change of trailer, a calibration drive must be carried out with the ball neck being used (→ page 305).

A correctly connected trailer influences, among other things, the functions of the following systems:

- ESP® trailer stabilization
- Trailer Maneuvering Assist
- Active Lane Keeping Assist
- Parking Assist PARKTRONIC
- Active Parking Assist
- Blind Spot Assist or Active Blind Spot Assist
- Drive Away Assist
- Cross traffic warning
- Maneuvering brake function
- Rear view camera

- 360° camera
- AIRMATIC
- E-ACTIVE BODY CONTROL

Vehicles without level control system: the ball head height will change depending on the vehicle's load. In this case, use a trailer with a height-adjustable drawbar.

Coupling up a trailer

! **NOTE** Damage to the starter battery due to full discharge

Charging the trailer battery using the power supply of the trailer can damage the starter battery.

- ▶ Do not use the vehicle's power supply to charge the trailer battery.

Information about a suitable ball neck for Mercedes-Benz vehicles can be obtained from a qualified specialist workshop, e.g. an authorized Mercedes-Benz Center.

- ▶ Secure the vehicle against rolling away.

- ▶ Remove the cover cap from the ball neck mount and store it in a safe place (→ page 302).
- ▶ Position the trailer on a level surface behind the vehicle and couple it up to the vehicle.
- ▶ Establish the electrical connection between the vehicle and the trailer.
- ⓘ Accessories can be connected to the permanent power supply up to 180 W and to the power supply that is switched on via the ignition lock.

Uncoupling a trailer

! **WARNING** Risk of being crushed and becoming trapped when uncoupling a trailer

When uncoupling a trailer with an engaged inertia-activated brake, your hand may become trapped between the vehicle and the trailer drawbar.

- ▶ Do not uncouple trailers with an engaged overrun brake.

! **NOTE** Damage during uncoupling with an engaged overrun brake

The vehicle may be damaged if you uncouple with an engaged overrun brake.

- ▶ Do not uncouple trailers with an engaged overrun brake.

! **WARNING** Risk of becoming trapped when disconnecting the trailer cable

Vehicles with level control system: the vehicle may lower when you disconnect the trailer cable.

This could result in other people becoming trapped if their limbs are between the vehicle body and the tires or underneath the vehicle.

- ▶ Make sure nobody is underneath the vehicle or in the immediate vicinity of the wheel arches when you disconnect the trailer cable.

- ▶ Secure the vehicle against rolling away.

- ▶ Disconnect the electrical connection between the vehicle and the trailer.
- ▶ Uncouple the trailer.
- ▶ Remove the ball neck and, in doing so, observe the installation instructions from the ball neck manufacturer.
- ▶ Place the cover on the ball neck mount.

Making settings for trailer operation

Multimedia system:

-  ▶ Settings ▶ Vehicle ▶ Driving
▶ Trailer settings

Making settings for a trailer

The settings in this menu enable the calculation of a route suitable for the selected trailer and optimize the calculated arrival time.

- ▶ Select the desired trailer type.
- ▶ The maximum permissible speed of the set trailer.
- ▶ **To save changes:** select **Confirm**.

Calibrating a trailer coupling

- ▶ Select **Trailer coupling has been changed** to start calibration for the new ball head position.
- ▶ **To save changes:** select **Confirm**.
- ▶ Then activate Trailer Maneuvering Assist and follow the corresponding instructions in the central display. As soon as the **Activated: Trailer Maneuvering Assist** message is displayed, calibration is complete. Trailer Maneuvering Assist can now be used.

Vehicle towing instructions

The vehicle is not suitable for the use of tow bar systems that are used for flat towing or dinghy towing, for example. Attaching and using tow bar systems can result in damage to the vehicle. When you are towing a vehicle with tow bar systems, safe driving characteristics cannot be guaranteed for the towing vehicle or the towed vehicle. The vehicle-trailer combination may swerve from side to side.

Observe the following information:

- Permitted towing methods (→ page 403)

- **Plug-in hybrid:** permitted towing methods (→ page 405)
- The notes on towing the vehicle with both axles on the ground (→ page 406)

Notes on the driver's display

⚠ WARNING Risk of accident if the driver display fails

If the driver display has failed or is malfunctioning, function restrictions in systems relevant to safety cannot be detected.

The operating safety of your vehicle may be impaired.

- ▶ Drive on carefully.
- ▶ Have the vehicle checked immediately at a qualified specialist workshop.

! NOTE Mercedes-AMG vehicles

- ▶ Observe the notes in the Supplement. You could otherwise fail to recognize dangers.

If the operating safety of your vehicle is impaired, park the vehicle immediately and safely. Contact a qualified specialist workshop.

The driver's display shows basic information such as speed, engine speed, fuel level, coolant temperature as well as indicator and warning lamps. Additional functions available include the following:

- Different menus, e.g. for assistance and navigation
- Status displays for the driving systems
- Display messages
- Information on speed, **Consumption** and range
- Power meter level and state of charge of the high-voltage battery
- Indicator and warning lamps

Some menu content and settings can be customized.

Operating the driver's display

⚠ WARNING Risk of distraction from information systems and communications equipment

If you operate information systems and communication devices integrated in the vehicle when driving, you could be distracted from the traffic situation. This could also cause you to lose control of the vehicle.

- ▶ Only operate this equipment when the traffic situation permits.
- ▶ If you cannot be sure of this, stop the vehicle whilst paying attention to road and traffic conditions and operate the equipment with the vehicle stationary.

Observe the legal requirements for the country in which you are currently driving when operating the driver's display.

Scrolling on the menu bar

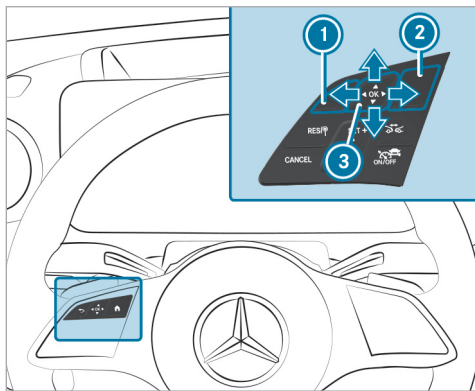

- ① Back button
- ② Main menu button
- ③ Touch Control

The content on the driver's display is controlled using the control elements on the left side of the steering wheel. You can use Touch Control ③ to navigate vertically and horizontally by swiping with

one finger. Confirm your selection by pressing the Touch Control.

- ① To operate Touch Control ③ in the most effective way, use the tip of your thumb if possible. You can also set the sensitivity of the Touch Control on the central display .
- ▶ Briefly press main menu button ② .
- ▶ Select a menu by swiping to the left or right on Touch Control ③ .
- ▶ **To confirm:** press Touch Control ③ .

Driver display menus

Notes on menus on the driver's display

⚠ WARNING Risk of distraction from information systems and communications equipment

If you operate information systems and communication devices integrated in the vehicle when driving, you could be distracted from the traffic situation. This could also cause you to lose control of the vehicle.

- ▶ Only operate this equipment when the traffic situation permits.
- ▶ If you cannot be sure of this, stop the vehicle whilst paying attention to road and traffic conditions and operate the equipment with the vehicle stationary.

Observe the legal requirements for the country in which you are currently driving when operating the driver's display.

The following menu can be called up via the menu bar on the driver's display:

- Understated
- Sport
- Classic
- Navigation
- Assistance
- Offroad (vehicles with 4MATIC)
- Service

On some of these menus, you can choose between different display content on the center display area.

On most of the menus, you can use **Options** to configure further settings for the menu-specific display content.

You can find further information about the possible settings and selections on the menus in the Digital Operator's Manual.

Calling up displays on the Sport menu

Driver's display:



The **Sport** menu displays information about the engine data, the setup and the temperature of the vehicle.

▶ **To call up the menu:** swipe to the left or right on the left-hand Touch Control.

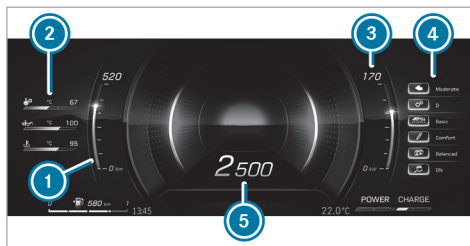

- ① Current torque
 - ② Temperature (transmission oil temperature, engine oil temperature, coolant temperature)
 - ③ Current power output
 - ④ Setup (drive position, transmission position, AMG DYNAMICS, suspension tuning, exhaust system, ESP®)
 - ⑤ Engine speed
- ⓘ Depending on the vehicle equipment, AMG-specific content regarding temperature, setup and engine data will be displayed. The settings for the setup display content can be configured either via the buttons on the multi-function steering wheel or via the MBUX mul-

timedia system . You can also activate or deactivate ESP® using the steering wheel button or via the MBUX multimedia system.

Calling up displays on the Sport menu (plug-in hybrid)

Driver's display:



The **Sport** menu provides additional information about the operating energy as well as the recuperated output of the vehicle.

- ⓘ When you call up the **Sport** menu on the menu bar of the driver's display, the menu color setting will automatically be applied to the MBUX multimedia system.

▶ **To call up the menu:** press the left-hand Touch Control.

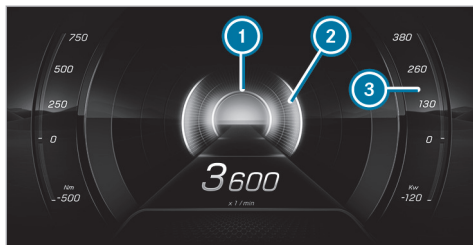

- ① Display range of recuperated power (recuperation)
- ② Display range of the output
- ③ Additional display range of the output

Head-up Display

Function of the head-up display

The head-up display projects various content into the driver's field of vision, for example.

You can use the head-up display menu bar to select various contexts, e.g.:

- Minimal

- Sport
- Standard
- Offroad (vehicles with 4MATIC)
- ECO display (depending on model and equipment) (→ page 184)
- Settings
- Head-up display on/off

The following image shows an example of the head-up display. You can choose what content is displayed (→ page 309).

System limits

Visibility is particularly influenced by the following conditions:

- Seat position
- Image position setting
- Ambient light
- Wet road surfaces
- Objects on the display cover
- Polarization in sunglasses

Operating the head-up display

Selecting display content of the head-up display via the menu bar of the driver's display

- ▶ Press the  main menu button on the left.
- ▶ **To select the menu bar of the head-up display:** swipe upwards on the left-hand Touch Control.



Switching between display content on the head-up display

- ▶ Swipe to the left or right on the left-hand Touch Control.
A preview of the selected display content will appear on the head-up display.

- ▶ **To confirm:** press the **[OK]** button.

Switching back to the driver's display

- ▶ Press the **[←]** or **[🏠]** button.

Setting the position and brightness

- ▶ Swipe to the left or right on the left-hand Touch Control and select **Settings** on the menu bar of the head-up display.
- ▶ Press the left-hand Touch Control. The current position and brightness settings will be displayed as graphics on the head-up display as well as on the driver's display.
- ▶ **To adjust the position:** swipe upwards or downwards on the left-hand Touch Control.
- ▶ **To adjust the brightness:** swipe to the left or right on the left-hand Touch Control. The settings configured for position and brightness will be saved automatically.
- ▶ Press the **[←]** or **[OK]** button to exit the settings.

Switching the head-up display on/off

Driver's display:



Switching on

- ▶ Swipe upwards on the left-hand Touch Control.
- ▶ Press left-hand Touch Control **[OK]**.

Switching off

- ▶ Swipe upwards on the left-hand Touch Control.
- ▶ Swipe on the left-hand Touch Control and select **Head-up Display**.
- ▶ Press left-hand Touch Control **[OK]**.

Vehicles with a 48 V on-board electrical system

- ① Electric drive support
- ② Recuperation behavior of the electric motor
- ⓘ Due to various system limits, the values displayed may temporarily differ slightly from the actual value.

Function of the power meter



- ① Start of the POWER display range
- ② End of the POWER display range
- ③ Current state of charge of the high-voltage battery
- ④ Maximum recuperated energy
- ⑤ Start of the display range of recuperated energy

The power meter has the following functions:

- In electric mode, the area ① - ② shows what percentage of the electrical drive is currently being used. The combustion engine is switched on at 100%. In boost mode, the elec-

trical power assistance of the drive is displayed.





- The area ④ - ⑤ shows the recuperation and charging behavior using the combustion engine.
- i** Due to various system limits, the displayed value ④ may temporarily differ slightly from the actual value.



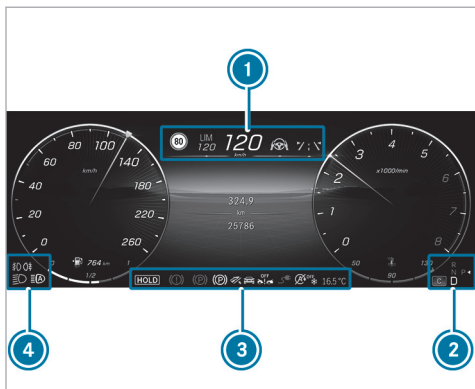











Overview of status displays on the driver's display

The status displays for the driving and driving safety systems can be found in display sections ① to ④.

① to ④.



-  Pedestrian detection (only on assistant display)
-  Active Parking Assist is available (→ page 293)
-  Active Parking Assist has recognized a parking space (→ page 293)
-  Parking Assist PARKTRONIC deactivated (→ page 290)

-  Cruise control (→ page 237)
-  Active Distance Assist DISTRONIC (→ page 239)
-  Specified distance for Active Distance Assist DISTRONIC (→ page 239)
-  Active Brake Assist switched off (→ page 257)
-  Active Brake Assist impaired or not functioning (→ page 257)
-  Active Steering Assist (→ page 248)
-  Active Lane Change Assist (→ page 251)
-  Active Lane Keeping Assist (→ page 263)
-  Active Blind Spot Assist (only on assistant display) (→ page 262)
-  Plug-in hybrid operation activated
-  Haptic accelerator pedal (→ page 188, 190, 185)
-  ECO start/stop function (→ page 182)
-  HOLD function (→ page 234)
-  Adaptive Highbeam Assist (→ page 144)
-  Active Stop-and-Go Assist (→ page 246)

312 Driver's display

 Slippery road surface warning

Vehicles with Traffic Sign Assist: Detected instructions and traffic signs (→ page 258)

Notes on operating safety

For your own safety, always observe the following points when operating mobile communications equipment and especially your voice control system:

- Observe the legal requirements for the country in which you are driving.
- If you use the voice control system in an emergency your voice can change and your telephone call, e.g. an emergency call, can thereby be delayed.
- Familiarize yourself with the voice control system functions before starting the journey.

i The voice control system does not replace the Operator's Manual.

The answers from the voice control system do not provide the complete scope of information contained in the Operator's Manual. The voice control system also does not give detailed warning or damage information. Therefore read the Operator's Manual so that you are fully informed about the functions and the safe operation of the vehicle.

Notes on operating safety

For your own safety, always observe the following points when operating mobile communications equipment and especially your voice control system:

- Observe the legal requirements for the country in which you are driving.
- If you use the voice control system in an emergency your voice can change and your telephone call, e.g. an emergency call, can thereby be delayed.
- Familiarize yourself with the voice control system functions before starting the journey.

Operation

Function of the MBUX voice assistant

Using the MBUX voice assistant, vehicle functions and various areas of the MBUX multimedia system can be operated by voice input, e.g. Navigation or Telephone. The MBUX voice assistant is operational about half a minute after switching on the vehicle and can be operated from all seats (depending on the optional equipment).

Conducting a dialog

Requirements:

- Voice activation is activated in the multimedia system (→ page 315).
- For corrections during output, the **Speak During Voice Output** option must be activated in the multimedia system (→ page 315).

Starting a dialog

▶ Say **Hey Mercedes** to activate the MBUX voice assistant.

or

▶ Press the  button on the multifunction steering wheel. A wave appears in the MBUX multimedia system. The dialog can be started.

For the dialog with the MBUX voice assistant, you can use complete sentences of colloquial language as voice commands. Voice activation can also be combined directly with a voice command, e.g. **Hey Mercedes, how warm is it outside?**

Interrupting the dialog

- ▶ During the dialog say **Pause**.
The dialog is interrupted.
- ▶ Say **Hey Mercedes** to continue the dialog.

Correcting an entry

- ▶ During the dialog say **Correction**.
or
- ▶ Interrupt the system's voice output.

Changing dialog level

- ▶ During the dialog, say **Back**.
The MBUX voice assistant jumps back to the previous dialog step.
- ▶ During the dialog, say **From the beginning again**.
The MBUX voice assistant jumps to the highest dialog level.

Navigating in the selection list

If a voice command does not achieve a clear result, a selection list is shown.

- ▶ Say the line number or the content to select an entry or to have further details shown.

- ▶ Say **Next page** or **Previous page** to browse the selection list.

Calling up help

- ▶ **For information about the MBUX voice assistant:** say **Hey Mercedes, what can you do?** .
- ▶ **Current application:** say **Help**.
You will receive suggestions and information about operation of the MBUX voice assistant for the current application.
- ▶ **Specific function:** call up the voice command for the required function, for example with **Hey Mercedes, I need help with the radio**.
- ▶ **Digital Operator's Manual:** say **Show me the Operator's Manual**.
The full extent of the Digital Operator's Manual is available on the media display when the vehicle is stationary.

Overview of the operable functions of the MBUX voice assistant

You can use the MBUX voice assistant to operate the following functions depending on the vehicle equipment:

- Telephone
- Text message and e-mail
- Navigation
- Radio and media
- Vehicle functions
- Online functions

Full functionality of the voice control system is only available for you with activation of online voice control (→ page 315).

Information on the language setting

You can change the language of the MBUX voice assistant via the system language settings (→ page 336). If the set system language is not supported by the MBUX voice assistant, English will be selected.

Setting functions of MBUX voice assistant using the multimedia system

Multimedia system:

→  >> Settings >> System
 >> Voice Assistant

Switching voice activation of MBUX voice assistant on or off

- ▶ Select **Hey Mercedes**.
When the function is active, the Hey Mercedes voice command can activate the dialog.

Switching direct commands on or off

- ▶ Select .
- ▶ Activate or deactivate the function.
If the function is active, some commands can be used without Hey Mercedes, for example Next track.

Switching voice activation for individual seats on or off

- ▶ Select .

- ▶ Switch the function for the desired seats on or off.

Switching voice interruption on or off

- ▶ Select **More Settings**.
- ▶ Select **Speak During Voice Output**.
If the function is active, a command can be interjected during voice output of the system.

Switching proactivity on or off

- ▶ Select **More Settings**.
- ▶ Select the desired situation, e.g. **Profile Activation** or **Telephone Forgotten**.
When the function is active, the voice assistant proactively provides information in specific situations.

Activating or deactivating online voice control

- ① Online voice control is activated at the factory.
- ▶ Select **Online Voice Control**.
- ▶ Activate or deactivate the function.
If the function is activated and a Mercedes me user account is linked to the vehicle, additional results are available through the provi-

sion of external information, e.g. information on POIs. By clicking the symbol in the wave, more information about the online voice control can be displayed.

Activating or deactivating contacts for online use

- ▶ Select **Contacts for Online Use**.
When the function is active, contacts will be found more easily and accurately using voice input.

Using the Voice Control System effectively

Notes on optimum use of MBUX voice assistant

- The MBUX voice assistant is operational half a minute after switching on the vehicle and can be operated from all seats, depending on the equipment installed. The system recognizes from which seat the command was spoken and performs actions according to the seat position.
- When a dialog is ended, the MBUX voice assistant continues to be active for as long as the wave is displayed in the multimedia system.

You can say another voice command without saying **Hey Mercedes**.

- Using the direct command **Change language to English**, the system language can be changed to English without **Hey Mercedes**. Direct commands must be activated for this.
- If a user profile has been stored and is active, the MBUX voice assistant can make suggestions based on the habits of the user. If the voice commands are not clear, the system selects an action. The action can be corrected with a new voice command.

Say **Hey Mercedes, load my personal profile**, to activate the profile. The user's voice must first be learned by the system and assigned to a profile.

Further information on user profiles .

- With the MBUX voice assistant, incoming calls can be accepted or rejected without the keyword **Hey Mercedes**.

Information on the MBUX online voice assistant

The online voice control facilitates recognition and thanks to external information makes additional results available.

Therefore, Mercedes-Benz recommends that you activate online voice control (→ page 315).

You will need a Mercedes me user account for this. If you do not yet have a user account you have to create one and connect it with your vehicle .

Then call up your Mercedes me user account. The Mercedes me services are shown and can be activated .

By clicking on the symbols displayed in the wave, further information on the online status is displayed.

When online voice control is active, additional functions are available such as:

- Weather
- General knowledge
- Public holidays and school holidays
- Smarthome

- Messages
- Time, date and time zones
- Pocket and currency calculator
- Football results and fixture lists
- Share prices
- Calendar
- ChitChat
- Horoscope
- Geo Quiz

i The availability of these functions is country and equipment-dependent.

i Text content is taken from Wikipedia in accordance with the CC BY-SA 3.0 license.

Essential voice commands

Notes on voice commands

It is not necessary to use exact voice commands to call up a specific function. The MBUX voice assistant also understands you when you use your colloquial speech. Some examples are listed

below. For some languages however these examples are only available to a limited extent.

Examples of voice commands:

- Navigation (→ page 317)
- Telephone (→ page 317)
- Radio and TV (→ page 317)
- Media player (→ page 317)
- Messages (→ page 318)
- Vehicle functions (→ page 318)
- Online functions (→ page 319)

Examples of navigation voice commands

You can operate the navigation system using the MBUX voice assistant. The following list offers just a small selection of the possible navigation commands. You will receive additional suggestions if you say **Help for navigation**.

- Drive me home.
- Where is the nearest service station?
- Is there a service area along the route?
- Set Central Park as intermediate destination.

- Cancel the route guidance.
- Show my last destination.
- I want to buy juice.
- Search for a French restaurant in Manhattan.

Examples of telephone voice commands

You can operate phones connected with MBUX multimedia system the using the MBUX voice assistant. The following list offers just a small selection of the possible telephone commands. You will receive additional suggestions if you say **Help for phone**.

- Call Peter Miller on the mobile phone.
- Dial 0711 17 0.
- Call my father.
- Accept call
- Reject call
- Search for the contact Peter Miller.
- Switch to address book
- Show me the incoming calls.
- Switch the phone

Examples of radio and TV voice commands

Depending on the vehicle equipment, you can operate the radio and TV using the MBUX voice assistant. The following list offers just a small selection of the possible radio or TV voice commands. You will receive additional suggestions if you say **Help for radio** or **Help for TV**.

- Play the radio station Heart FM.
- Next station.
- Previous station.
- Show me the list of radio stations
- Save the station
- What am I listening to?

Examples of media voice commands

You can operate connected media sources and online music using the MBUX voice assistant. The following list offers just a small selection of the possible media voice commands. You will receive additional suggestions if you say **Help for media** or **Help for player**.

- Play Michael Jackson.

- Play "Yellow Submarine" by the Beatles.
- Next track.
- Previous track.
- Play similar track.
- Repeat this track.
- Switch on random playback.
- Mute the music.
- Switch to USB.

Examples of message voice commands

Messages can be created, edited and listened to using the MBUX voice assistant. The following list offers just a small selection of the possible message commands. You will receive additional suggestions if you say Help for messaging.

- Write a text message to Jane Doe: When will the next meeting take place?
- Show me my new e-mails.
- Write an e-mail to Jane Doe.
- Read me my new text messages.
- Show all new text messages.
- Write an e-mail to John Doe in English

Examples of vehicle voice commands

You can operate vehicle settings and vehicle functions using the MBUX voice assistant. The following list offers just a small selection of the possible vehicle voice commands.

- **i** If no seat is mentioned for commands, the action is carried out automatically for the seat from which the command was spoken or for the function which is closest to that seat.
- Switch the seat heating to level 2.
- My feet are cold.
- Start the Refresh program.
- Switch the relaxation function on.
- I would like to set the ambient light to blue
- Switch on the reading lamp.
- Turn off the rear light.
- Open all the windows.
- Switch the driver's display to 3D.
- How fast can I drive here?

- Tell me my next service appointment
- How warm is it outside?

Information about the vehicle can also be requested:

- Information about individual items of the vehicle equipment
 - Hey Mercedes, which relaxation programs do you have?
 - Hey Mercedes, do I have Blind Spot Assist?
 - Hey Mercedes, where is the warning triangle?
- Information about functioning of the systems and components installed in the vehicle
 - Hey Mercedes, what is DISTRONIC?
 - Hey Mercedes, what do I need ESP for?
 - Hey Mercedes, what is MBUX?
- Information about operating the systems and components installed in the vehicle
 - Hey Mercedes, how do I connect my smartphone?

- Hey Mercedes, how can I turn on the high-beam headlamps?
- Hey Mercedes, how do I stop the ionization function?

You can also use the vehicle voice commands to directly call up the menus for the plug-in hybrid settings and operate the corresponding vehicle functions.

- "Display the energy flow."
- "Switch to charging settings."
- "Activate pre-entry climate control."
- "Where is the nearest charging station?"
- "How far can I still drive?"
- "Set the departure time to tomorrow morning at 8 am."

Examples of online functions

Depending on the country, language and vehicle equipment, additional functions are available when online voice control is active. The system accesses external information and can, as a

result, answer general knowledge questions and make calculations, for example.

- Is the sun shining in Manchester?
- Is it raining at my location?
- What are the skiing conditions on the Zugspitze?
- What's the time in Sydney now?
- In which country do you pay with dollars?
- How many Swiss franks make 25 euros?
- How long now until the holidays?
- What day is it tomorrow?
- What is 20% of 29?
- What does my horoscope say?
- What is the price of Mercedes-Benz Group shares?
- Let's play Geo Quiz.
- I'm bored.
- Who is the current president?
- What do you know about the Globe Theatre in London?
- Who painted the picture "The Scream"?

- What's the status in the Premier League?
- Create a calendar entry tomorrow at 9 am.
- What's my next task?
- Tell me a joke.
- How many languages do you speak?
- What is your favorite animal?
- Are there any updates?
- Is the light still on in the kitchen?
- Switch off all the devices in my house.
- Please set the temperature in the living room to 24 degrees.

Direct command examples

With direct commands, some functions can be operated without first saying the voice command **Hey Mercedes**. To use direct commands, the function must be activated in the multimedia system (→ page 315).

- Next TV channel
- Previous TV channel
- Next radio station

320 MBUX voice assistant

- Previous radio station
- Next station
- Previous station
- Next track
- Previous track
- Start dashcam recording
- Stop dashcam recording
- Show the map
- 3D map
- 2D map
- Align map to north
- Align map in direction of travel
- Show all routes
- Show traffic
- Navigate to work
- Navigate home
- Repeat driving instruction
- Cancel route guidance
- Change language to English

Overview and operation

Notes on the MBUX multimedia system

⚠ WARNING Risk of distraction from information systems and communications equipment

If you operate information systems and communication devices integrated in the vehicle when driving, you could be distracted from the traffic situation. This could also cause you to lose control of the vehicle.

- ▶ Only operate this equipment when the traffic situation permits.
- ▶ If you cannot be sure of this, stop the vehicle whilst paying attention to road and traffic conditions and operate the equipment with the vehicle stationary.



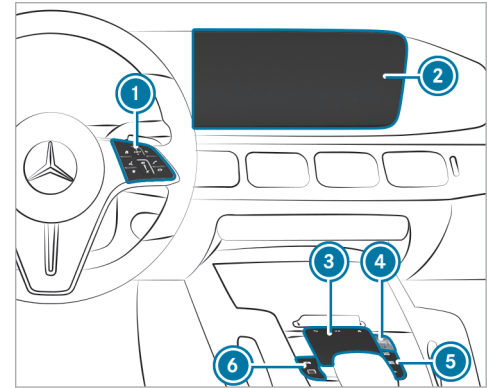

You must observe the legal requirements for the country in which you are currently driving when operating the multimedia system. Depending on the equipment, the scope of function and product designation of your MBUX multimedia system may differ from the description and

images in this Operator's Manual. For example, route guidance with augmented reality is not available in all equipment variants.

Overview of the MBUX multimedia system



- ① Touch Control and control panel for the MBUX multimedia system
MBUX stands for Mercedes-Benz User Experience.
 - Operating Touch Control
- ② Media display with touch functionality
 - Home screen overview

- Operating the touchscreen
- Touchpad
Operating the touchpad
 - Controller
Turn: adjusts the volume
Press briefly: switches the sound on/off
Press and hold: switches the MBUX multimedia system or media display on or off
 - Buttons for navigation , radio/media  and telephone 
 - Button for vehicle functions  and the fingerprint sensor 

Further operating options:

- Conducting a dialog with the MBUX voice assistant.
 - Operating functions contact-free with the MBUX Interior Assistant.
- i** You can find further information about operation as well as about applications and services in the Digital Operator's Manual.

Anti-theft protection

This device is equipped with technical provisions to protect it against theft. Further information on anti-theft protection can be obtained at an authorized Mercedes-Benz Center.

Home screen overview

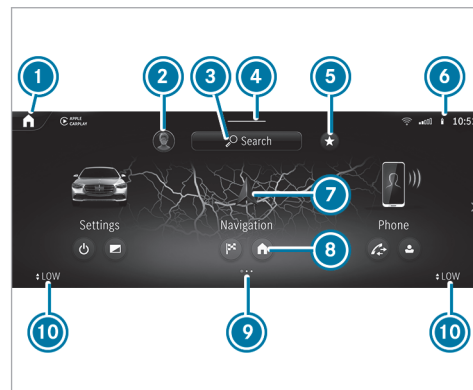

- On the home screen: displays the first three applications
In other displays: calls up the home screen
- Calls up user profile settings and switches user
- Uses the global search
- Calls up the Control Center: pull the bar down

- ⑤ Calls up favorites
- ⑥ Displays in the status line
- ⑦ Calls up an application
- ⑧ Quick-access to application
- ⑨ Index points for selected display area
- ⑩ Calls up the air conditioning menu

The following functions are called up in the Control Center:

- Notifications Center
- Favorites
- Vehicle quick-access

Operating the MBUX multimedia system

Using Touch Control

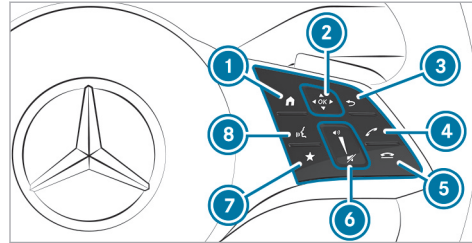

- ① Shows the home screen
- ② Touch Control
- Swipe in the direction of the arrow (navigate)
- Press (confirm)
- ③ Returns to the previous display
- ④ Makes or accepts a call
- ⑤ Rejects or ends a call
- ⑥ To increase volume: swipe upwards
To reduce volume: swipe down

To switch off the sound: press

⑦ Calls up favorites

⑧ Starts the MBUX voice assistant

① To operate Touch Control ② in the most effective way, use the tip of your thumb if possible.

You can navigate through menus and lists via the touch-sensitive surface of Touch Control ② using a **single-finger swipe**, e.g.:

- ▶ **To enter a character:** select a character using the keyboard and press on Touch Control ②.
- ▶ **To select a menu option:** scroll in a list and press Touch Control ②.
- ▶ **To move the digital map:** swipe in any direction.

Using the touchscreen



- ▶ **To select a menu item or entry:** tap on a symbol or an entry.
- ▶ **To increase the map scale:** tap twice quickly with one finger.
- ▶ **To reduce the map scale:** tap with two fingers.

- ▶ **To enter characters with the keypad:** tap on a button.
- ▶ **To navigate in menus:** swipe up, down, left or right.
- ▶ **To use handwriting to enter characters:** write the character with one finger on the touchscreen.
- ▶ **To zoom in and out of the map:** move two fingers together or apart.
- ▶ **To enlarge or reduce the size of a section of a website:** move two fingers together or apart.
- ▶ **To turn the digital map:** turn counter-clockwise or clockwise using two fingers.
- ▶ **To move the digital map:** touch the touchscreen and move your finger in any direction.
- ▶ **To save the destination in the digital map:** touch the touchscreen and hold until a message is shown.
- ▶ **To set the volume on a scale:** touch the touchscreen and move the finger to the left or right.

- ▶ **To call up a global menu in the applications:** touch the touchscreen and hold until the **Options** menu appears.

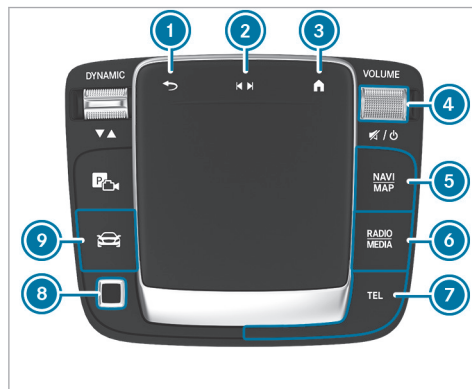
Using the touchpad



- ①  button
Returns to the previous display
- ②  button

Press: calls up the control menu of the last active audio source

- ③  button
Press: shows the home screen and calls up applications
- ④ Turn: adjusts the volume
Press briefly: switches the sound on/off
Press and hold: switches the MBUX multimedia system or media display on or off
- ⑤ Calls up the navigation system or map
- ⑥ Calls up radio or media
- ⑦ Calls up the telephone
- ⑧ Fingerprint sensor
- ⑨ Calls up vehicle functions

- ▶ **To enter a character:** enter a character using the keyboard.

or

- ▶ Write a character on the touch-sensitive surface of the touchpad.
- ▶ **To select a menu item or entry:** swipe up, down, left or right and tap on the touchpad.

- ▶ **To move the digital map:** swipe in any direction.
- ▶ **To zoom in and out of the map:** move two fingers together or apart.
- ▶ **To enlarge or reduce the size of a section of a website:** move two fingers together or apart.
- ▶ **To call up the Notifications Center:** swipe down with two fingers.
- ▶ **To close the Notifications Center:** swipe up with two fingers.
- ▶ **To call up the control menu of the last active audio source:** swipe up with two fingers.

Function of the MBUX voice assistant

⚠ WARNING Risk of distraction from information systems and communications equipment

If you operate information systems and communication devices integrated in the vehicle when driving, you could be distracted from the traffic situation. This could also cause you to lose control of the vehicle.

- ▶ Only operate this equipment when the traffic situation permits.
- ▶ If you cannot be sure of this, stop the vehicle whilst paying attention to road and traffic conditions and operate the equipment with the vehicle stationary.

For your own safety, always observe the following points when operating mobile communications equipment and especially your voice control system:

- Observe the legal requirements for the country in which you are driving.
- If you use the voice control system in an emergency your voice can change and your telephone call, e.g. an emergency call, can thereby be delayed.
- Familiarize yourself with the voice control system functions before starting the journey.

Using the MBUX voice assistant, vehicle functions and various areas of the MBUX multimedia system can be operated by voice input. The MBUX voice assistant is operational approximately half a minute after switching on the vehicle and can be

operated from all seats. Further information and examples of voice commands can be found in the Digital Operator's Manual.

You can use the MBUX voice assistant to operate the following functions depending on the vehicle equipment:

- Telephone
- Text message and e-mail
- Navigation
- Radio and media
- Vehicle functions
- Online functions

Full functionality of the voice control system is only available for you with activation of online voice control.

Conducting a dialog

Starting a dialog

- ▶ Say "Hey Mercedes" to activate the MBUX voice assistant. Voice activation must be switched on in the multimedia system.

or

- ▶ Press the  button on the multifunction steering wheel. A blue line appears in the MBUX multimedia system. The dialog can be started.

For the dialog with the MBUX voice assistant, you can use complete sentences of colloquial language as voice commands. Voice activation can also be directly combined with a voice command, e.g. "Hey Mercedes, how fast can I drive?"

Calling up help

- ▶ **For information about the MBUX voice assistant:** say "Hey Mercedes, what can you do?"
- ▶ **Digital Operator's Manual:** "Show me the Operator's Manual". The full extent of the Digital Operator's Manual is available when the vehicle is stationary.

Operating functions (examples)

- ▶ **To operate the navigation:** "Search for an Asian restaurant, but not Japanese, in South Manhattan."
- ▶ **To operate the phone:** "Call my father."

- ▶ **To change the system language to English (short command):** "Change language to English".
- ▶ **To operate the radio:** "Show me the list of radio stations."
- ▶ **To operate media:** "Switch on random playback."
- ▶ **To operate vehicle functions:** "Switch the seat heating to level 2."
- ▶ **To operate online functions:** "What's the time in Sydney?"
- ▶ **To ask a question about the vehicle:** "Do I have Blind Spot Assist?"

Overview of the MBUX Interior Assistant

⚠ WARNING Risk of injury from the camera's laser radiation

This product uses a classification 1 laser system. If the housing is opened or damaged, laser radiation may damage your retina.

- ▶ Do not open the housing.

- ▶ Always have maintenance work and repairs carried out by a qualified specialist workshop.

This product complies with the requirements of the FDA 21 CFR 1040.10 and 1040.11 with exception of the variations according to the FDA Laser Notice No. 50 from 24. June 2007.

The camera is located in the overhead control panel.

If the vehicle is equipped with the MBUX Interior Assistant, selected functions of the multimedia system can be operated contact-free. The MBUX Interior Assistant can differentiate between driver and front passenger interactions and detects specific hand positions (poses).

System limits, display messages and notes for rectification

The system may be impaired or may not function in the following situations:

- The camera in the overhead control panel may heat up due to operating conditions. As a result the camera may switch off temporarily,

particularly during longer periods of operation and at high outside temperatures.

Do not touch or cover the camera and wait until the camera has cooled down and is available again.

- The camera is covered, dirty, fogged up or scratched.

Wait until the camera has cooled down before cleaning the camera lens.

Clean the outside of the camera lens with a dry or damp cotton cloth. Do not use micro-fiber cloths. Do **not** remove the cover when cleaning.

- Recognition can be impaired by reflective clothing, an adverse color of clothing or by accessories, for example.

- Clothing being worn (hat, shawl, scarf) may be limiting the detection area of the camera.

Keep the camera's field of vision clear.

- The camera is not operational.

Consult an authorized Mercedes-Benz Center.

The MBUX Interior Assistant supports the following interactions:

Interaction area	Interaction	Description
In front of the media display or above the touchpad	Proximity to the control element	The Interior Assistant recognizes the approach of the hand towards a control element. Depending on the active application, the display will be adjusted in the media display. Some functions differentiate between driver and front passenger. No specific hand position is required.
Above the center console	Defined pose	A favorite is called up with a defined pose.

Interaction area	Interaction	Description
Below the inside rearview mirror	Brief up and down movements	With brief up and down movements below the inside rearview mirror the reading light for the driver or the front passenger is switched on or off.
Above the front passenger seat	Stretching out a hand above the front passenger seat	By stretching out a hand above the front passenger seat the search light is switched on. If you withdraw a hand from this area, the search light is switched off again.

Switching the reading light and search light and on or off

Requirements

- **For the reading light:**
 - The function is available when it is dark.
 - The hand movement takes place in the interaction area below the inside rearview mirror.
- **For the search light:**
 - The function is available when it is dark.
 - The hand movement takes place in the interaction area above the front passenger seat.

- The seat belt on the front passenger seat must **not** be inserted in the seat belt buckle.

Switching the reading light on and off



- ▶ Briefly move a hand up or down beneath the inside rearview mirror. The reading light is switched on or off for the driver or the front passenger.

Switching the search light on and off



- ▶ **To switch on:** reach across the front passenger seat with a hand. The search light is switched on for the driver.
- ▶ **To switch off:** take a hand back away from the front passenger seat. The search light is switched off again.

Information on users, suggestions and favorites

⚠ WARNING Risk of becoming trapped during adjustment of the driver's seat after calling up a driver profile

Selecting a user profile may trigger an adjustment of the driver's seat to the position saved under the user profile. You or other vehicle occupants could be injured in the process.

- ▶ Make sure that when the position of driver's seat is being adjusted using the multimedia system, no people or body parts are in the seat's range of movement.

If there is a risk of someone becoming trapped, immediately stop the adjustment process by:

- ▶ a) Pressing the warning message on the central display.
- or
- ▶ b) Pressing a position button of the memory function or a seat adjustment switch in the driver's door. The adjustment process is stopped.

The driver's seat is equipped with an anti-entrapment feature.

If the driver's door is open, the driver's seat will **not** be set after calling up the driver's profile.

User profiles and user-specific content

Prerequisites for the vehicle owner:

- You have a Mercedes me user account.
 - You have a Mercedes me PIN.
 - You have agreed to the terms of use.
 - The vehicle is linked to a Mercedes me user account.
- ⓘ If one of the pre-requisites listed is missing or if no user profile has been selected, the data described in the following section will be

saved in the vehicle as the standard setting. Standard settings can be changed by all vehicle users.

User profiles save personal settings. If the vehicle is used by several people, a person can change their profile settings without changing the settings of other users.

You can individualize a user profile in the vehicle using the set-up assistant or using the settings in your user profile. Some settings, e.g. the Mercedes me PIN and a profile photo are made in the Mercedes me App or in the Mercedes me Portal.

User-specific content and applications with personal data are protected by different levels of security. To access protected content, the Mercedes me PIN and, depending on the vehicle equipment, biometric sensors can be used.

- ⓘ The security level is set by the multimedia system and calculated from the combination of all sensor inputs. Some security levels cannot be turned off.

i When a user profile is activated, the following personalized comfort systems, for example, can be adjusted or their settings loaded:

- Seat
- Ambient light
- Outside mirrors
- Roller sunblinds
- Climate control settings

If the user profile is activated when driving, the driver's seat position will not be adjusted.

Depending on the vehicle equipment you can, as a user, save the following settings, for example:

- Driver's seat, steering wheel and mirror settings
- Climate control
- Ambient lighting
- Radio (including station list)
- Suggestions and favorites

Suggestions

The vehicle can learn the habits of the driver. It then makes suggestions regarding navigation des-

tinations, phone numbers and music preferences. The requirements for that are the selection of a user, your consent to the recording of data and sufficient collected data.

Favorites

Favorites offer you quick access to frequently used applications. 100 favorites are available in total.

Configuring users, suggestions and favorites

Requirements

- To use the set-up assistant: the vehicle is stationary.

Multimedia system:



Adding a user

- ▶ Select **+** **Add User**. A QR code is loaded.
- ▶ Scan the displayed QR code with the Mercedes me App or any QR code scanner on a mobile device. If the Mercedes me App is not yet installed on your mobile device, you

will be directed to the store of your mobile device.

- ▶ Follow the directions in the app. The vehicle is connected with your Mercedes me user account. This automatically creates your user profile in the vehicle.

If only your user profile is available, it will be loaded automatically.

If more than one user profile is available, you will be directed to the user selection.

When the vehicle is stationary, the set-up assistant starts automatically after user selection.

Protecting user-specific content and applications

If you add a new user, access protection is already activated for the user profile. The Mercedes me PIN and, depending on the vehicle equipment, biometric sensors are available for access. Biometric sensors in the vehicle must be taught in. The authentication process then takes all taught-in and available sensors into account.

The following user-specific content and applications are protected, for example:

- User selection and user profile settings
 - Biometric sensors
 - The teaching-in of biometric sensors is protected.
 - Suggestions
 - The data and determination of the most probable navigation destinations, media sources, radio stations, contacts and messages are protected.
 - ENERGIZING COACH
 - The recorded health data and their evaluation are protected.
 - Mercedes me connect store
 - The purchase of services is protected.
- ▶ Switch **Protect Content** on or off.
- ▶ Switch **Access Protection** on or off.
- ⓘ When access protection is switched off, your user profile can be viewed from any seat and changes can be made.

- ⓘ Access protection is switched on or off on a vehicle-specific basis.

Teaching in, editing and deleting biometric data

The biometric data models are saved in the sensors in the vehicle. If recognition has been taught-in, this sensor serves as a contributory factor for authentication on the multimedia system.

- ▶ Select **Protect Content**.
 - ▶ Select **Facial Recognition, Fingerprint Recognition** or **Voice Recognition**.
- ⓘ If necessary, authenticate yourself on the multimedia system.

Authenticating using face recognition

- ▶ Close the driver's door or fasten the driver's seat belt.
- ▶ Look at the driver's display for about five seconds. Your face is scanned. A message in the driver's display shows whether facial recognition was successful or not. You can unlock your user profile and protected applications with the facial scan.

Authenticating using fingerprints

Authenticating using voice recognition

- ⓘ Avoid background or disturbing noises during voice recognition.

Deleting biometric data

- ▶ Tap on , for example, behind **Facial Recognition**.
- ▶ Select **Yes**.

Teaching in the vehicle key for profile selection

- ▶ Select **Protect Content**.
- ▶ Select **SmartKey Recognition**.
- ▶ Have the key ready and follow the set-up assistant's prompts. The user profile is linked to the selected key. If you open the vehicle with the key, the light, mirror and seat settings for your user profile are pre-activated. The key you are currently using for unlocking is used. The key is only stored for the driver and for one user profile.

Selecting a user

- ❶ When you call up your driver profile, the driver's seat and the steering wheel can be set. You can cancel the setting process with the following actions:



- Press one of the seat operating buttons in the driver's door.

- ▶ Select **Change User**.
- ▶ Select a user.
- ▶ When requested to do so, authenticate with the Mercedes me PIN or a taught-in biometric characteristic. The user profile is loaded and activated.





- ❷ If you select **Continue Without Selecting a User**, no specific settings for the user profile are loaded.

Configuring and deleting suggestions

- ▶ Select .
- ▶ Select **Settings**.
- ▶ Select **System**.
- ▶ Select **Suggestions**.

- ▶ Select .
- ▶ Switch the options on or off individually. If an option is switched on and sufficient data has been gathered, personalized suggestions based on your user behavior will be offered to you on the zero layer. These are, for example, navigation destinations visited, phone numbers dialed as well as suggestions based on your music preferences.
- ▶ **To delete collected suggestions:** select .
- ▶ Select **Yes**. The suggestions are reset.

Adding favorites from categories

- ▶ Select .
- ▶ Select .
- ▶ Select .
- ▶ Select  **Create New Favorite**.
- ▶ Select the category.
- ▶ Select a favorite.

System settings

Overview of the system settings menu

In the system settings menu, you can make settings in the following menus and control elements:

- Display
 - Display brightness
- Control elements
 - Keyboard language and handwriting recognition
 - Sensitivity of the Touch Control
 - Haptic operation for the touchscreen
- MBUX voice assistant
- MBUX Interior Assistant
- Sound
 - Entertainment
 - Navigation and traffic announcements
 - Telephone
 - Voice amplification
- Data protection

- Connectivity
 - Wi-Fi, Bluetooth®, NFC
- MBUX rear tablet child safety lock
- Time & date
- Language
- Units for distance
- System PIN
- Suggestions
- Software update
- System reset

Overview of software updates

Important software updates may be necessary for the security of your multimedia system's data. Install these updates, or else the security of your multimedia system cannot be ensured.

The multimedia system displays a corresponding message when a software update is available.

If the [Automatic Online Update](#) option is active, software updates are downloaded automatically. If the option is deactivated, you will be informed of

new software updates once. The software updates are available for downloading for a limited period of time.

Carrying out a software update:

- You can start software updates via the communication module.
 - You can start software updates via a Wi-Fi hotspot.
 - You can start map updates from an external medium.
- ❗ Online software updates cannot be performed via external Wi-Fi hotspots that are encrypted via TKIP.
 - ❗ If the Wi-Fi hotspot requires logging in via the browser, once the connection is successfully established the browser will open in order to start the update. Follow the instructions in the browser in order to start the download.
 - ❗ To complete software updates via the communication module, the vehicle must be connected with the Internet and a Mercedes me user account.

- ❗ To complete software updates via Wi-Fi, the vehicle must be connected to an external Wi-Fi hotspot.

A software update consists of three steps:

- Downloading or copying of the data required for installation
 - Installation of the downloaded software update
 - Activation of the downloaded software update
- ❗ It may be necessary to restart the MBUX multimedia system after completion of a software update.
 - ❗ While some software updates are being downloaded, the multimedia system cannot be operated and the vehicle functions may be restricted.
 - ❗ Some software updates require a safe vehicle status for the installation to be completed. They can only be carried out in a safely parked vehicle with the vehicle switched off.

For software updates requiring a safe vehicle status: when the last installation step is reached, a message appears on the media display after the

vehicle is switched off. Follow the step-by-step instructions on the media display to complete the installation.

There are software updates that can only be installed when the vehicle is safely parked, there are no more people in the vehicle and the vehicle is locked.

Availability of the driver's and media display

During the installation of software updates, it is not possible to use the vehicle, media display and driver's display. You may receive the following display message when an installation is running:

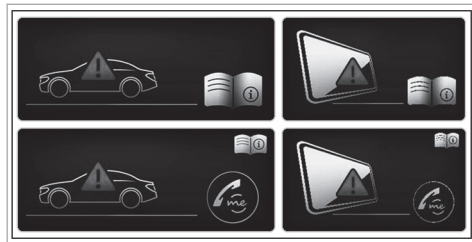

- i The display message does not appear every time a software update is installed.

In rare cases, an error can occur during the installation. The multimedia system automatically attempts to restore the previous version.

If it is not possible to restore the previous version, the display message shown above appears every time the vehicle is started.

Failure of the driver's display

If the driver's display fails or there is a malfunction, you may not recognize limitations in the functions of systems relevant to safety or the speed display, for example. The operating safety of the vehicle may be impaired. Drive on carefully and have the vehicle checked at a qualified specialist workshop immediately (→ page 486).

Further information about software updates can be found at <https://me.secure.mercedes-benz.com>

Failure of the media display

If the media display fails or the display message shown above is shown continuously, several systems such as the rear view camera, Parking Assist PARKTRONIC or climate control are no longer available. Drive on carefully and consult a specialist workshop as soon as possible.

Setting up a Wi-Fi hotspot

Requirements:

- The Wi-Fi function is activated on the multimedia system and the communication device to be connected.
- The communication device to be connected supports at least one of the types of connection described.

The connection types shown depend on the device to be connected. The function must be supported by the multimedia system and by the device to be connected. The type of connection must be selected on the multimedia system and on the device to be connected.

- i Some functions may first need to be activated on the communication device being connected. More detailed information can be found in the manufacturer's operating instructions.
- i The use of the vehicle data tariff by external devices is not available in all countries.

Multimedia system:

→  » Settings » System
» Internet and Bluetooth

i The availability of the functions is dependent on the country.

- ▶ Select **Wi-Fi**.
The controller is to the right: Wi-Fi is switched on.

When the Wi-Fi function is switched on, you can connect the multimedia system with external hotspots or make it available as a hotspot for external devices.

When the Wi-Fi function is switched off, it is not possible to establish a hotspot connection.

When the Wi-Fi function is switched off, no connection can be established with the MBUX rear tablet.

i Depending on the vehicle equipment, you can purchase a data package directly from a mobile phone network provider via the Mercedes me Store. To be able to use the data package, you conclude a separate contract with a mobile phone network provider

via the Mercedes me Store, which can be terminated at any time and for which there are no costs. This contract is a prerequisite for using the services from the previously purchased package. The availability of this option is dependent on the country. If the data package option is not available or can be upgraded, you can purchase data volume directly from the mobile phone network provider for a fee.

i The use of the vehicle data tariff by external devices is not available in all countries.

Using the multimedia system as a Wi-Fi hotspot

- ▶ Select **MBUX Hotspot**.
- ▶ Select one of the following connection options.

Connecting using a QR code

Requirement: an app for scanning the QR code is installed on the device being connected.

Alternatively: the device being connected has an integrated QR code scanner (see manufacturer's operating instructions).

- ▶ Scan the QR code shown.
The Wi-Fi connection is established.

Connecting using NFC

- ▶ Activate NFC on the device to be connected.
- ▶ When the NFC symbol is displayed in the **MBUX Hotspot** menu, hold the device to be connected to the NFC interface.
- ▶ Follow the instructions on the device.
The Wi-Fi connection is established.

Connecting using a security key

- ▶ Select the vehicle from the device to be connected. The vehicle is displayed with the **MBUX XXXXX** network name.
- ▶ Enter the security key which is shown in the media display on the device to be connected.
- ▶ Confirm the entry.

Generating a new security key

- ▶ Select the **Generate New Security Key** option in the **MBUX Hotspot** menu.
- ▶ Confirm the prompt with **Yes**.
A new security key is generated.

A connection will be established with the newly created security key.

- ❶ When a new security key is generated, all existing Wi-Fi connections are then disconnected. If the Wi-Fi connections are being re-established, the new security key must be entered.

Using a mobile communication device as a Wi-Fi hotspot (tethering)

- ❶ This function is country-dependent.
 - ▶ Select the [Manage Internet Access](#) option in the [Internet and Bluetooth](#) menu.
 - ❷ The Wi-Fi function on the mobile phone and Internet access via Wi-Fi must be activated (see the manufacturer's operating instructions).
 - ▶ Select [Search for Access](#).
 - ▶ Select the network.
 - ▶ Log in to the Wi-Fi network.
- or
- ▶ Select the mobile phone with the  Wi-Fi symbol.

- ❸ With external Wi-Fi hotspots, which are encrypted via TKIP, online software updates cannot be carried out via the external Wi-Fi hotspot.

System language

Notes on the system language

This function allows you to determine the language for the menu displays and the navigation announcements. The selected language affects the characters available for entry. The navigation announcements are not available in all languages. If a language is not available, the navigation announcements will be in English.

Setting the language

Multimedia system:

  ▶▶ [Settings](#) ▶▶ [System](#)
▶▶ [Language](#)

Setting the system language

A list of the available system languages is shown.

- ▶ Select a language.
The system language is switched to the selected language.

Resetting the multimedia system (reset function)

⚠ WARNING Risk of accident due to failure of central display functions

While the multimedia system is reset, its functions, such as the rear view camera, are not available.

- ▶ Only reset the multimedia system when the vehicle is stationary.

Requirements:

- The vehicle is switched on.
- Some settings can only be reset when the vehicle is stationary.

Multimedia system:

  ▶▶ [Settings](#) ▶▶ [System](#) ▶▶ [Reset](#)

When resetting the system, personal data and settings are deleted, for example:

- Connected devices
- Individual user profiles
- Biometric data

- Vehicles with rear telephony: handset connection
- i** The data used and saved in the multimedia system by the driver assistance systems is deleted.
- i** Vehicles with rear telephony: The handset must be in the cradle while the system is reset.
- ▶ Select **Reset**.
A query appears asking if the system should really be reset.
- ▶ Select **Yes**.
The multimedia system is reset to the factory settings. The multimedia system is restarted after the system reset.
- i** Due to data protection, as well as the function of individual driving systems and driving safety systems, it is a requirement to carry out a complete system reset before selling the vehicle or transferring it to a third party, or after use as a hire car.

Plug-in hybrid settings

Configuring the charging settings

Multimedia system:

→  ▶▶ Hybrid ▶▶ Charging

Setting the charging program

- ▶ Select **Home**, **Work** or **Standard**.

Unlocking the charging cable (mode 3 or 4)

When the function is active, the charging cable is unlocked when the maximum charge level is reached.

- ▶ Select **Home** or **Work**.
▶ Activate or deactivate **Unlock Charging Cable**.

Activating or deactivating location-based charging

- ▶ Select **Charging Program**, **Home** or **Charging Program**, **Work**.
▶ Activate or deactivate **Select Based on Location**.

When the function is activated, the vehicle's current position is saved as one of the selected options. When the address is reached again, a

brief query appears as to whether the respective charging program should be selected.

Activating or deactivating rapid charging

- ▶ Activate or deactivate the **Fast Charging** function.

The **Fast Charging** function increases the maximum possible charging capacity at charging stations up to 60 kW in order to charge the vehicle's high-voltage battery more quickly. After the charging process is complete, the charging capacity in the "Standard" charging program is again limited to 20 kW in order to protect the high-voltage battery.

Setting the departure time

The set departure times will be used for the vehicle's pre-entry climate control.

- ▶ Select **Next Departure Time**.

The following charging times can be selected:

- individual charging times
- a **Week Profile**

Setting an individual departure time

▶ Select **Add New Time** and set the time.

or

▶ Select  and adapt an existing departure time.

Setting the repeat days

▶ Select **Add New Time** and set the time.

▶ Mark the relevant weekdays for which the departure time will apply and confirm with **OK**.

or

▶ Select  and edit existing repeat days.

Setting the maximum charge level

▶ Select **Maximum State of Charge**.

▶ Set the desired percentage.

The high-voltage battery is charged up to the set percentage as a maximum.

ⓘ The percentage can be set in increments of 10%.

ⓘ As soon as the full charge level is reached, a notification is shown in the media display that

the charging process is completed and the journey may be continued.

Functions of the energy flow display

The active components of the hybrid system are highlighted on the energy flow display. The energy flow between the individual components is shown in color.

The energy flow is shown in different colors depending on the operating status:

- **White:** constant energy flow
- **Red:** high energy flow (boost effect)
- **Green:** low-emission energy flow in the case of recuperation, electric mode and charging the high-voltage battery

Calling up the energy flow display

Multimedia system:

  **▶▶ Info**

▶ Select **Energy Flow**.

The energy flow in the vehicle will be displayed.

Information on the status of the hybrid system and the current state of charge of the high-voltage battery will be displayed in addition to the energy flow.

Off-road menu**Off-road menu overview in the multimedia system**

The **Off-road** menu provides an overview of the most important, relevant data for off-road driving. The content is displayed in different tiles that can be changed with directional arrows or swipes. In addition, this menu contains buttons for quick-access to certain vehicle functions that are relevant to off-road operation.

Displayed data are, for example:

- Artificial horizon
- Compass
- Altitude
- Steering angle of the front and rear wheels
- Torque and power
- Tire pressure and temperature
- Transparent hood

Further settings for Offroad Assist and Offroad Score can be made in the **Offroad** menu.



- ❶ Further information on Offroad Assist (→ page 279).
- ❷ Further information on Offroad Score.

Setting the off-road menu in the multimedia system

Multimedia system:

→  → **Offroad** → **Cockpit**

Setting displays in the central display

- ▶ Press  ,  or on the display itself to jump to the next display.

Quick-access: activating/deactivating Parking Assist PARKTRONIC

- ▶ Press  to switch the function on or off.
- ❶ Further information on Parking Assist PARKTRONIC (→ page 287).

Quick-access: activating/deactivating ESP® (Electronic Stability Program)

- ▶ Press  to switch the function on or off.
- ❶ Further information on ESP (→ page 231).

Quick-access: activating or deactivating manual gear changing

- ▶ Press  to switch the function on or off.
- ❶ Additional information on manual shifting (→ page 198).

Quick-access: activating or deactivating DSR (Downhill Speed Regulation)

- ▶ Press  to switch the function on or off.
- ❶ Further information on DSR (→ page 246).

Navigation and traffic

Notes on navigation

Route guidance with augmented reality

- ⚠ **WARNING** Risk of accident and injury as a result of distraction, incorrect depiction or wrong interpretation of the display

The camera image of the augmented reality display is not suitable as a guide for driving.

- ▶ Always keep an eye on the actual traffic situation.
- ▶ Avoid extended observation of the camera image.

- ⚠ **WARNING** Risk of accident and injury due to imprecise positioning of additional information

The additional information from the augmented reality display may be inaccurate and is not a substitute for observing and assessing the actual driving situation.

- ▶ Always keep an eye on the actual traffic situation when carrying out all driving maneuvers.

Switching navigation on

Multimedia system:



- ▶ Alternatively, press the  button on the steering wheel on the right (→ page 323). The zero layer with the digital map is displayed.

Navigation overview

Digital map

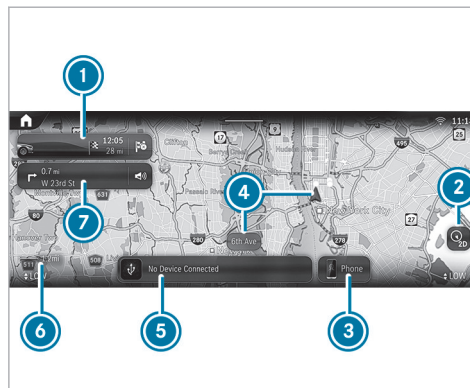

- 1 Navigation module (reduced view)
Route guidance active:
The navigation module shows the information relevant to the route in the zoomed-out view, e.g. the destination or a traffic delay
 Ends the current route guidance

Tapping opens the navigation module and displays the route overview

- 2 Map orientation  and set map type
- 3 Calls up the telephone menu
- 4 Current vehicle position (vehicle symbol or arrow)
- 5 Calls up entertainment applications
- 6 Elevation and map scale
- 7 Navigation window shows the next driving maneuver (zoomed out view) or the route monitor (zoomed in view)

Route guidance active: route monitor shows, e.g. route sections, upcoming driving maneuvers with lane recommendations, destination, traffic delays, 3D images at freeway exits, online content

Pressing  several times changes the map orientation in this order:

- 2D and to the north
- 2D and direction of travel
- 3D and direction of travel
- Map with complete route

i If the map is moved, the map switches between 3D direction of travel and 2D north orientation.

The following map types **2** are available:

- Daytime display
- Night-time display
- Satellite map

i If you notice a problem with the digital map you can report this under <https://mapfeedback.here.com/#/report>.

Navigation module (expanded view)

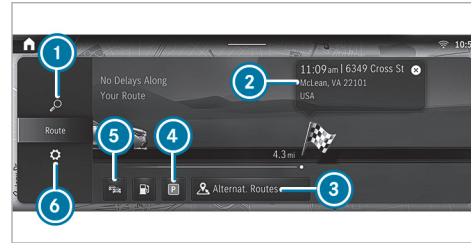

Example: route guidance is active

- 1 Enters an address or POI
- 2 Destination and time of arrival

Below this: current distance to the destination and the checkered flag

- 3 Alternative routes
- 4 Searches for parking
- 5 Switches traffic information display on or off
- 6 Makes settings for [View](#), [Messages & Acoustic Signals](#) and [Route](#)

Overview of the toll system

i The toll system is optional equipment and is not available in all vehicles.

Debiting of toll charges at freeway toll gates is facilitated with an electronic payment system.

The toll system uses RFID (Radio Frequency Identification) for data transfer between the control unit and the toll station.

The toll system is initially switched off at the factory.

The control unit is in the vehicle glove box.

In order to be able to use the toll system, it must have been registered by the customer and activated by the service provider:

- Activate the toll system in the settings of the MBUX multimedia system or on the control unit.
- There are two ways to register and activate:
 - In the Mercedes me App, register the unit identification number of the control unit and activate the toll system.

- Alternatively, you can register and activate via the [Toll Service](#) app.

Activation of the toll system can take up to 48 hours after registration.

When the toll system is activated, the automatic detection of the number of vehicle occupants is initially switched off at the factory. The number of vehicle occupants is preset with one person.

The following applies for roads on which toll charges are dependent on the number of vehicle occupants:

- If the automatic detection of the number of vehicle occupants is switched off, the number of vehicle occupants must be selected manually. This ensures correct toll accounting.
- The number of vehicle occupants can be transmitted automatically. In the process, the number of seat belts worn is determined.

If the number of detected persons does not correspond with the number of persons actually in the vehicle, the number of persons must be manually selected.

The standard setting of one person does not need to be changed for roads which require toll payment regardless of the number of vehicle occupants.

The toll system enables the payment of toll charges in many states of the USA.

i In Mexico, for example, the toll system can be registered and activated for journeys to the USA.

Notes on use

- You can only use the toll system once registration and activation are complete.
- Drive at the prescribed vehicle speed in the toll lane.
- Mercedes-Benz recommends operation using the MBUX multimedia system. Alternatively, this can also be done on the control unit in the glove box.
- For safety reasons, entries should be made while the vehicle is stationary.
- For further information, please consult the Mercedes me App or an authorized Mercedes-Benz Center.

Or call 1-800-FOR-MERCEdes (in the USA) or 1-800-387-0100 (in Canada).

For information on how to register and activate the toll system, see the Digital Operator's Manual.

Destination entry

Requirements

- **For the online search:**

- There is an Internet connection.
- Mercedes me connect is available.
- You have set up a user account in the Mercedes me Portal.
- The vehicle is connected with the user account and you have accepted the terms of use.
- Further information can be found at: <https://www.mercedes.me>
- The service is available.
- The service has been activated at an authorized Mercedes-Benz Center.

- ❗ If Online Search is not available, the search is performed using the data of the digital map.

Multimedia system:

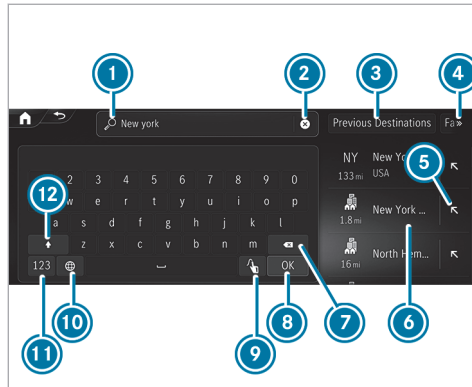

Example: entering a POI or address

- 1 Input line with current entry
- 2 Deletes an entry
- 3 Selects previous destinations

- 4 Displays and selects additional destination searches
- 5 Adopts the search result in the input line and continues the search
- 6 Search result
- 7 Deletes the last character entered
- 8 Hides the keypad
- 9 Switches to handwriting recognition
- 10 Sets the written language
- 11 Switches to digits and special characters
- 12 Switches to upper-case or lower-case letters

If available, selecting the  symbol starts the MBUX voice assistant.

- ▶ Enter the destination in 1. The entries can be made in any order. The search results are displayed in a list.
- ❗ Online search results for POIs may contain additional information, for example opening times and ratings. The information is provided by an online map service. This online function is not available in all countries.

- ❗ You can enter a destination as a three-word address from what3words. This option is not available in all countries.
- ▶ Hide the keyboard with **OK**.
- ▶ Select the destination in the list. The following menu shows the selected destination with the address information and a corresponding map section. The menu enables the route to be calculated.
- ❗ Observe the notes on the MBUX multimedia system (→ page 321).

Calculating a route and using settings for route guidance



Example: detailed display

- ➊ Calls up alternative routes
- ➋ Calculates the route and starts route guidance
- ➌ Selects a point of interest in the vicinity of the destination
- ➍ Destination address

After selection of a destination the route is calculated.

- ▶ Select one of the options.

Calling up alternative routes

- ▶ Select **Routes**.
- ▶ Select an alternative route.

Starting route guidance

- ▶ Select **Let's Go!**.

Calling up the detailed display with destination address

- ▶ Pull the bar above **➋** upwards. Depending on the destination selection and availability, online content, for example ratings and weather information, is shown. If the destination is in a different time zone, a message is displayed.
- ▶ **To share a destination:** select **Share**. This option allows you to scan the displayed QR code.
- ▶ **To save a destination as a favorite:** select **Favorite** and then an option.
- ▶ **To call up an Internet address:** if a web address is available, select **www**.

- ▶ **To call the destination:** if a telephone number is available, select **Call**.

Searching for POIs in the vicinity of the destination shown

- ▶ Select **In The Vicinity**.
- ▶ Search using categories, enter a search entry or search for a personal POI.

Selecting a route type

- ▶ In the navigation module (expanded view), select (→ page 340).
- ▶ Select **Route**. The route is calculated as a fast route with a short journey time. Trailer mode is available if a trailer has been coupled with the vehicle. If available, you can select online routes. Traffic announcements for the route are taken into account via **Reroute Based on Traffic** .

i Trailer mode and online routes are not available in all countries and for all vehicles.

Calculating alternative routes

- ▶ In the navigation module (expanded view), select .

- ▶ Select **View**.
- ▶ Activate **Route Overview after Start**.
Alternative routes are calculated for every route.

Selecting alternative routes

- ① If **Route Overview after Start** has been switched on and a route has been calculated, the function is available.
- ▶ In the navigation module (expanded view), select **Alternative Routes**.
- ▶ When the alternative routes have been calculated, display the route in the navigation window by swiping to the right or left.
- ▶ Select **Start**.

Activating a commuter route

- ① A user profile has been created and **Allow Destination Suggestions** has been activated in the user options (→ page 330). Route guidance is not active.
- ▶ In the navigation module (expanded view), select .

- ▶ Select **Route**.
- ▶ Activate **Activate Commuter Route**.
The navigation system automatically detects that the vehicle is on a commuter route.
For the daily commuter route, traffic events on the route are also reported when driving without active route guidance.
- ▶ **To select or delete a commuter route:**
select **Start** or .

Avoiding or using route sections, e.g. highways or ferries

- ▶ In the navigation module (expanded view), select .
- ▶ Select **Route**.
- ▶ Select **Avoid Options**.
- ▶ Activate or deactivate the avoid option.

Using map functions

Multimedia system:



Increasing map scale

- ▶ When the map is shown, tap twice quickly with one finger on the media display.
- or
- ▶ Move two fingers apart on the media display.

Decreasing map scale

- ▶ Tap with two fingers on the media display.
- or
- ▶ Move two fingers together on the media display.

Moving the map

- ▶ When the map is displayed, swipe in any direction with one finger on the media display.
- ▶ **To reset the map to the current vehicle position:** select  **Center**.

Selecting map orientation

▶ Tap repeatedly on the  compass symbol on the map.

The map orientations changes in this order:

- The 2D map view is displayed so that north is always at the top.
- The 2D map view is aligned to the direction of travel.
- The 3D map view is aligned to the direction of travel.
- The map shows the complete route.

Using services

Requirements:

- There is an Internet connection.
- Mercedes me connect is available.
- You have set up a user account in the Mercedes me Portal.
- The vehicle is connected to a user account and you have accepted the conditions of use for the service.

Further information can be found at: <https://www.mercedes.me>

- The service is available.
- The service has been activated at an authorized Mercedes-Benz Center.

Multimedia system:



Showing traffic information

- ▶ In the navigation module (expanded view), select  (→ page 340).
- ▶ Select [View](#).
- ▶ Activate [Traffic](#).
- ▶ Activate [Traffic Incidents](#) and [Free Flowing Traffic](#).
Traffic incidents, for example roadworks, local area reports (e.g. fog) and warning messages, are shown on the route.
The traffic delay is displayed for the current route. The smallest value for the display for traffic delays is a minute.

Displaying hazard warnings

If hazard warnings are available these can be shown as symbols on the map. The display depends on the settings for the [Traffic Incidents](#) option.

- ▶ In the navigation module (expanded view), select  (→ page 340).
- ▶ Activate or deactivate [Traffic Incidents](#).
If the option is activated, all of the symbols are shown.
If the option is deactivated, the symbols are only shown when there is a hazard warning.
The following hazards may be shown on the map:
 - Accidents and breakdowns
 - Slippery roads, fog, crosswinds and heavy rain
 - Hazards reported manually
 - Vehicle with active hazard warning light
 - Roadworks
 - Additional hazards (if available)

Displaying online map contents

- ▶ In the navigation module (expanded view), select .
- ▶ Select **View**.
- ▶ Switch on an online service, e.g. **Weather**. Current weather information is displayed on the navigation map, e.g. temperature or cloud cover.
The service information is not shown in all map scales, e.g. weather symbols.

Parking service

! **NOTE** Damage to the vehicle due to not observing the maximum permitted headroom clearance

If the vehicle height is greater than the maximum permitted headroom clearance, the roof and other parts of the vehicle may be damaged.

- ▶ Observe the signposted headroom clearance.

- ▶ If the vehicle height is greater than the permitted headroom clearance, do not enter.
- ▶ Observe the changed vehicle height with add-on roof equipment.



! **NOTE** Vehicle damage due to failure to observe local information and parking conditions

The data is based on the information provided by the respective service providers.

Mercedes-Benz does not guarantee the accuracy of the information provided in relation to the car park or parking area.

- ▶ Always observe the local information and conditions.

i This service is not available in all countries.

- ▶ In the navigation module (expanded view), select  and switch on **Parking**.
- ▶ Tap on  the map.

or

- ▶ In the route overview, select  **Parking Spaces**.
- ▶ Select the search position and search filter, e.g. **Near destination** and **Parking garages**. The map shows car parks suited to the selected settings.
- ▶ Select a parking option.
The map shows the parking options in the vicinity.
The following information is displayed (if available):
 - Destination address, distance from current vehicle position and arrival time
 - Information on the parking garage/car park
For example, opening times, parking charges, current occupancy, maximum parking time, **maximum access height**.
 The maximum access height shown by the parking service does not replace the need for observation of the actual circumstances.

- Available payment options (Mercedes pay, coins, bank notes, cards)
 - Details on parking tariffs
 - Number of available parking spaces
 - Payment method (e.g. at parking meters)
 - Services/facilities at the parking option
 - Telephone number
- Calculate the route (→ page 344).

Notes on the dashcam

! **NOTE** Risk of legal consequences due to violation of legal regulations and data protection provisions

You are legally responsible for operation and use of the dashcam functions.

The legal requirements relating to operation and use of the dashcam can vary depending on the country in which the dashcam is operated.

This function is not permitted in all countries.

- Before using the dashcam, read up on the content of the legal regulations, in particular the data protection requirements in the respective country of use.
- Observe the legal regulations, in particular the data protection requirements.

- i** Observe the following instructions for safe operation:
- Only use FAT32 or exFAT formatted USB storage devices.
 - Use USB-IF certified USB storage devices. USB-IF is a non-profit corporation and stands for USB Implementers Forum. Based on the USB specification, USB-IF certifies, for example, USB versions, corresponding cables and plugs as well as energy supply processes via the USB interface.
 - USB storage devices may be damaged if often or permanently overwritten at high speed. Mercedes-Benz recommends a high-quality external SSD drive.

The abbreviation SSD stands for Solid State Drive.

- i** The file size and therefore the duration of single recording is limited by the limitations of the USB flash drive format. So FAT32 formatted USB flash drives do not allow files larger than 4 GB, for example. When the file size is reached, the recording stops and you receive a notification.
- i** The following functions are available in the Gallery app:
- Switching write protection on or off
 - Deleting video files

Selecting a USB device for a video recording with the dashcam

Requirements:

- At least one USB device is connected with the multimedia system .

Multimedia system:

►  ► Apps ► Dashcam

- Select the USB symbol.

- ▶ Select the USB device.
- ❗ When USB devices contain multiple partitions, recorded video files are not always displayed in the recording list.
Mercedes-Benz recommends that you use USB devices with one partition.

Starting or stopping video recording with the dashcam

Requirements:

- For recording and saving a video file: a USB device is connected with the multimedia system .
- The ignition is switched on.

Multimedia system:

→  ▶▶ Apps ▶▶ Dashcam

- ▶ If several USB devices are connected with the multimedia system, select a USB device (→ page 348).
If no USB device is selected, a selection is made automatically when recording starts.

- ▶ **To select a recording mode:** select [Loop Recording](#) or [Individual Recording](#).
[Loop Recording](#) records several short video files. When the memory is full, recording is continued automatically. In doing so, other files will be overwritten starting with the oldest file.

[Individual Recording](#) stops recording when the memory limit is reached. An individual recording is automatically protected against being overwritten.

- ▶ **To start:** select [Start Recording](#).
The length of the recording is shown. The [Do not remove the storage medium during recording. Before removing the storage medium, eject it first.](#) message appears. The video file is stored on the USB device.

- ▶ **To end:** select [End Recording](#).

- ❗ In some countries, geo-coordinates (longitude and latitude) are shown in the video image. For technical reasons, the geo-coordinates may show greater inaccuracies.

A report may appear in the following cases:

- [Individual Recording](#): the memory is full or there are only a few minutes recording time available. The video recording stops or will be stopped imminently.
Change the USB device or delete a video file.
- The camera is not functional, the [Camera Unavailable](#) message appears.
Have the camera checked in an authorized Mercedes-Benz Center.
- If the country border indication has been switched on .

Telephone

Telephony

Notes on telephony

⚠ WARNING Risk of distraction from operating integrated communication equipment while the vehicle is in motion

If you operate communication equipment integrated in the vehicle when driving, you could be distracted from the traffic situation. This could also cause you to lose control of the vehicle.

- ▶ Only operate this equipment when the traffic situation permits.
- ▶ If you cannot be sure of this, stop the vehicle whilst paying attention to road and traffic conditions and operate the equipment with the vehicle stationary.

⚠ WARNING Risk of accident from operating mobile communication equipment while the vehicle is in motion

Mobile communication devices distract the driver from the traffic situation. This can also cause the driver to lose control of the vehicle.

- ▶ As a driver, only operate mobile communication devices when the vehicle is stationary.
- ▶ As a vehicle occupant, use mobile communication devices only in the designated area, e.g. in the rear passenger compartment.

You must observe the legal requirements for the country in which you are currently driving when operating the multimedia system and mobile communication equipment in the vehicle.

⚠ WARNING Risk of injury due to objects being stowed incorrectly

If objects in the vehicle interior are stowed incorrectly, they can slide or be thrown around

and hit vehicle occupants. In addition, cup holders, open stowage spaces and mobile phone receptacles cannot always retain all objects within.

There is a risk of injury, particularly in the event of sudden braking or a sudden change in direction.

- ▶ Always stow objects so that they cannot be thrown around in such situations.
- ▶ Always make sure that objects do not protrude from stowage spaces, parcel nets or stowage nets.
- ▶ Close the lockable stowage spaces before starting a journey.
- ▶ Always stow and secure heavy, hard, pointed, sharp-edged, fragile or bulky objects in the trunk/cargo compartment.

Observe the additional information on stowing mobile communications devices correctly:

- Loading the vehicle (→ page 119)

Bluetooth® connection:

The menu view and the available functions in the telephone menu are in part dependent on the Bluetooth® profile of the connected mobile phone. If the mobile phone supports all the following Bluetooth® profiles, the full range of features is available:

- PBAP (Phone Book Access Profile)
 - The contacts on the mobile phone are shown automatically on the multimedia system.
- MAP (Message Access Profile)
 - The mobile phone message functions can be used on the multimedia system.
- HFP (hands-free profile)
 - Wireless telephony is available on the multimedia system.
- SAP (SIM Access Profile)
 - The car telephone has access to the SIM card data and dials into the mobile phone network via the exterior antenna.

Irrespective of this, Bluetooth® audio functionality can be used with any mobile radio unit.

For information on the range of functions of the mobile radio unit to be connected, see the manufacturer's operating instructions.

Network connection:

The following cases can lead to the call being disconnected while the vehicle is in motion:

- You switch into a transmission/reception station, in which no communication channel is free.
- The SIM card used is not compatible with the network available
- A mobile phone with "Twincard" is logged into the network with the second SIM card at the same time

The multimedia system supports calls in HD Voice® for improved speech quality. A requirement for this is that the mobile phone and the mobile phone network provider of the person you are calling support HD Voice®.

Depending on the quality of the connection, the voice quality may fluctuate.

Further information can be obtained from an authorized Mercedes-Benz Center or at: <https://www.mercedes-benz.com/connect>.

Telephone menu overview

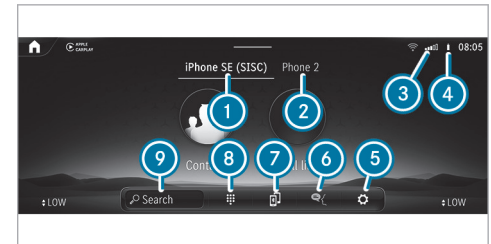

- ① Bluetooth® device name of the currently connected mobile phone/of the mobile phone
- ② Bluetooth® device name of the currently connected mobile phone/of the mobile phone (two phone mode)
- ③ Signal strength of the mobile phone network
- ④ Battery status of the connected mobile phone
- ⑤ Options
- ⑥ Messages

- 7 Calls up devices
- 8 Numerical pad
- 9 Starts contact search

■ Telephony operating modes overview

Depending on your equipment, the following telephony operating modes are available:

- A mobile phone is connected to the multimedia system via Bluetooth®.
- Two mobile phones are connected with the multimedia system via Bluetooth® (two phone mode).
 - You can use all the functions of the multimedia system with both mobile phones.

■ Connecting a mobile phone

Requirements

- Bluetooth® is activated on the mobile phone (see the manufacturer's Operator's Manual).
- Bluetooth® is activated on the multimedia system.

Multimedia system:



Searching for a mobile phone



- ▶ Select **Connect New Device**.

Connecting a mobile phone

- ▶ Select a mobile phone.
A code is displayed in the multimedia system and on the mobile phone.
- ▶ If both codes match, confirm the code on the mobile phone.

■ Functions in the telephony menu

In the telephony menu you have the following functions, for example:

- Making calls, e.g.:
 -  Accepting a call
 -  **End Call**
 - Answering a call with a message
 -  **Conference**
 - Accepting or rejecting a waiting call

- Managing contacts, e.g.:
 - Downloading mobile phone contacts
 - Managing the format of a contact's name
 - Deleting favorites
- Receiving and sending messages, e.g.:
 - Using the read-aloud function
 - Dictating a new message

Mercedes me Apps

Mercedes me calls

■ Making a call via the overhead control panel

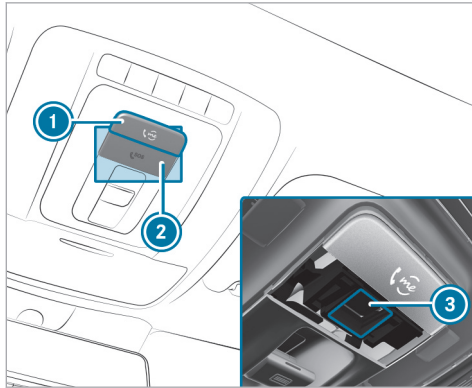

- ① me button for service or information calls
- ② SOS button cover
- ③ SOS button (emergency call system)

Making a Mercedes me call

- ▶ Press me button ①.

Making an emergency call

- ▶ To open the cover of SOS button ②, press it briefly.
- ▶ Press and hold SOS button ③ for at least one second.

If a Mercedes me call is active, an emergency call can still be triggered. This has priority over all other active calls.

■ Information about the Mercedes me call using the me button

A call to the Mercedes-Benz Customer Center has been initiated via the me button in the overhead control panel or the multimedia system (→ page 353).

Using the voice dialog system you access the desired service:

- Accident and Breakdown Management
- Mercedes-Benz Customer Center for general information about the vehicle

You can find information on the following topics:

- Activation of Mercedes me connect
- Operating the vehicle
- Nearest authorized Mercedes-Benz Center
- Other products and services from Mercedes-Benz

Data is transferred during the connection to the Mercedes-Benz Customer Center (→ page 355).

■ Calling the Mercedes-Benz Customer Center using the multimedia system

Requirements

- Access to a GSM network is available.
- The contract partner's GSM network coverage is available in the respective region.
- The vehicle must be switched on so that vehicle data can be transferred automatically.

Multimedia system:



▶ Call **Mercedes me connect**.

After confirmation, the multimedia system sends the required vehicle data. The data transfer is shown in the display.

Then you can select a service and be connected to a specialist at the Mercedes-Benz Customer Center.

■ **Calling the Mercedes-Benz Customer Center after automatic accident or breakdown detection**

Requirements

- The vehicle has detected an accident or breakdown situation.
- The vehicle is stationary.
- The hazard warning lights are switched on.

ⓘ This function is not available in all countries.

The vehicle can detect accident or breakdown situations under certain circumstances.

Requirements for collision detection in the context of accident management:

- The vehicle is equipped with an anti-theft alarm system (ATA) (code 551).
- The vehicle is equipped with the interior protection (code 882).
- The vehicle is equipped with the Anti-Theft Protection Package (code P54).
- The collision detection service with theft notification has been activated on Mercedes me connect.

If a collision is detected when the tow-away alarm is armed on a locked vehicle, you will receive a notification in the multimedia system when you switch the vehicle on.

The message informs you about the potentially affected area of the vehicle and the strength of the collision.

In the event an accident or breakdown is detected, the emergency guide shows safety notes in the multimedia system display. This may take a few seconds.

ⓘ The availability of collision detection depends on the vehicle.

After quitting the emergency guide display on the multimedia system, a prompt appears asking whether you would like to get support from the Mercedes-Benz Customer Center.

▶ Select **Call**.

- After your agreement, or if the Mercedes me connect service "Accident and Breakdown Management" is active, the vehicle data is transferred automatically (→ page 357).
- The Mercedes-Benz Customer Center takes your call and organizes the breakdown and accident assistance.

You may be charged for these services.

ⓘ Depending on the severity of the accident, an automatic emergency call can be initiated. This has priority over all other active calls (→ page 361).

- ❗ In addition, if the Mercedes me connect service "Telediagnosics" is active, a similar prompt can appear after a delay in the event of a breakdown. If you are already in contact with the Mercedes-Benz Customer Center or have already received support, this prompt can be ignored or declined.
- ❗ If you answer the prompt for support from the Mercedes-Benz Customer Center with **Call Later**, the message will be hidden and appear again later.
The prompt triggered by the Mercedes me connect service "Telediagnosics", can either be confirmed or declined. After being declined, this will not be shown again.

■ Arranging a service appointment via a Mercedes me call

If you have activated the maintenance management service, relevant vehicle data is transferred automatically to the Mercedes-Benz Customer Center. You will then receive individual recommendations regarding the maintenance of your vehicle.

Regardless of whether you have consented to the maintenance management service, the multimedia system reminds you after a certain amount of time that a service is due. A prompt appears asking if you would like to make an appointment.

▶ **To arrange a service appointment:** select **Call**. After your consent, the vehicle data is transferred and the Mercedes-Benz Customer Center takes your preferred appointment date. The information is then sent to your desired service outlet.

This will contact you to confirm the appointment and if necessary consult about the details.

- ❗ If you select **Call Later** after the service message appears, the message is hidden and reappears at a later time.

■ Data transferred during a Mercedes me call

If you initiate a service call using Mercedes me, data is transferred to enable targeted advice and an efficient service.

The following requirements must be fulfilled for the transfer of the data:

- The vehicle is switched on.
- The required data transfer technology is supported by the mobile phone network provider.
- The quality of the mobile connection is sufficient.

Multi-stage transfer depends on the following factors:

- Reason for the initiation of the call
- The available mobile phone transmission technology
- The activated Mercedes me connect services
- The service selected in the voice control system

- ❗ The scope of the data transmitted depends on the vehicle model and vehicle equipment. For technical reasons, not all data is available at all times.

Data transfer if Mercedes me connect services are not activated

If no Mercedes me connect services are activated, the following data is transferred:

- Vehicle identification number
- Time of the call
- Reason for the initiation of the call
- Confirmation of the data protection prompt
- Country indicator of the vehicle
- Set language for the multimedia system
- Telephone number of the communication platform installed in the vehicle

If a call is made for a service appointment via the service reminder, the following data is also transmitted:

- Current mileage and maintenance data

If a call is made after automatic accident or breakdown detection using the multimedia system, the following data is also transmitted:

- Current mileage and maintenance data
- Current vehicle location

If Accident and Breakdown Management is called via the voice control system, the following data can also be called up from the vehicle by the Mercedes-Benz Customer Center:

- Current vehicle location

Data processing

The data transmitted within the scope of the call is deleted from the processing system after the call is finished, in so far as this data is not being used for other activated Mercedes me connect services.

The incident-specific data is processed and stored in the Mercedes-Benz Customer Center and, if required to process the incident, forwarded to the service partner authorized by the Mercedes-Benz Customer Center. Take note of the data protection information on the Mercedes me Internet page <https://www.mercedes.me> or in the recorded message immediately after calling the Mercedes-Benz Customer Center.

-  The recorded message is not available in every country.

Mercedes me connect

Information on Mercedes me connect

Mercedes me connect consists of multiple services.

You can use the following services via the multimedia system and the overhead control panel, for example:

- Accident and Breakdown Management (me button or situation-dependent display in the multimedia system)
- Mercedes-Benz Emergency Call System (automatic emergency call and SOS button)

The Mercedes me connect Accident and Breakdown Management and the Mercedes-Benz emergency call center are available to you around the clock.

The me button and the SOS button can be found on the vehicle's overhead control panel (→ page 353).

You can also call the Mercedes-Benz Customer Center using the multimedia system (→ page 353).

Please note that Mercedes me connect is a Mercedes-Benz service. In emergencies, first call the national emergency services using the standard national emergency service telephone numbers. In emergencies, you can also use the Mercedes-Benz emergency call system (→ page 360).

Please note the Mercedes me connect terms of use and the data protection information for Mercedes me connect. You can find these in your Mercedes me user account.

Further information about Mercedes me connect services can be obtained in the Mercedes me Portal: <https://me.secure.mercedes-benz.com>

Information on Mercedes me connect Accident and Breakdown Management

- i** Accident and Breakdown Management is not available in every country. Contact an authorized Mercedes-Benz Center to find out whether this function is available in your country.

The Accident and Breakdown Management can include the following functions:

- Supplement to the Mercedes-Benz emergency call system (→ page 360)
If necessary, the contact person at the Mercedes-Benz emergency call center forwards the call to Mercedes me connect Accident and Breakdown Management. Forwarding the call is however not possible in all countries.
- Breakdown assistance by a technician on location and/or the towing away of the vehicle to the nearest authorized Mercedes-Benz Center
You may be charged for these services.
- Addition to the emergency guide after automatic accident or breakdown detection (→ page 354)
In the event of a breakdown or accident, further vehicle data is sent which enables optimal support by the Mercedes-Benz Customer Center and the authorized service partner or breakdown assistance.

- Addition to the Mercedes me connect service Telediagnosics
With the Telediagnosics function, specific wear and failure reports are recorded by the service provider, in so far as these can be clearly interpreted and are available through the monitoring of components that are subject to diagnostics.
If your vehicle detects a breakdown or threat of a breakdown, you may be prompted via the multimedia system to contact the Mercedes-Benz Customer Center for further help. This prompt in the multimedia system only appears when the vehicle is stationary.
- i** These services are subject to technical restrictions such as the mobile phone coverage, mobile network quality and the ability of the processing systems to interpret the transferred data. In some circumstances, this can result in delays or the failure of the information to appear in the multimedia system.
Please note that the service and breakdown call is a Mercedes-Benz service. In emergencies, be sure to contact the usual national emergency

number first or use the Mercedes-Benz emergency call system (→ page 360).

More information about Mercedes me connect services can be obtained in the Mercedes me Portal: <https://me.secure.mercedes-benz.com>

Data transferred during Mercedes me connect call services

The data transferred during a Mercedes me connect call depends on:

- The reason for initiation of the call
- The service that is selected in the voice control system
- The activated Mercedes me connect services

You can find out which data is transferred when using the services in the currently valid Mercedes me connect terms of use and the data protection information for Mercedes me connect. You can find these in your Mercedes me user account.

Overview of the Mercedes me & Apps menu

When you log in with a user account to the Mercedes me Portal, then services and offers from Mercedes-Benz will be available to you.

For more information consult an authorized Mercedes-Benz Center or visit the Mercedes me Portal: <https://me.secure.mercedes-benz.com>

- ① Make sure you always keep the Mercedes me Apps updated.

You can call up the menu using **Apps** in the multimedia system.

In the **Apps** menu, the following options can be available:

- Connecting the vehicle with the **Mercedes me** user account
- Deleting a connection between a user account **Mercedes me** and the vehicle
- Calling up the Mercedes me services
- Calling up apps such as In-Car Office or the web browser depending on availability

Web browser overview



- ① Previous website
 - ② Next website
 - ③ Update
 - ④ URL
 - ⑤ Adds/removes bookmarks
 - ⑥ Options
 - ⑦ Settings
- ① Under **⋮** you have the following options:
- **Tabs**
 - **Bookmarks & History**
 - **Reading Mode**

- [Share Link](#)
- [Share Content](#)
- [Request Mobile Website](#)

i Websites cannot be shown while the vehicle is in motion.

Overview of Smartphone Integration

With Smartphone Integration, you can use certain functions on your mobile phone via the multimedia system display.

Only one mobile phone at a time can be connected via Smartphone Integration to the multimedia system. Also for use with two phone mode with Smartphone Integration, only one additional mobile phone can be connected using Bluetooth® with the multimedia system.

The full range of functions for Smartphone Integration is only possible with an internet connection. The appropriate application must be downloaded on the mobile phone to use Smartphone Integration. The mobile phone must be switched on and connected to the multimedia system via the USB port using a suitable cable.

Apps for Smartphone Integration:

- Apple CarPlay® (wireless connection via Bluetooth® also possible)
- Android Auto (wireless connection via Bluetooth® also possible)

i For safety reasons, the first activation of Apple CarPlay® or Android Auto on the multimedia system must be carried out when the vehicle is stationary with the parking brake.

You can start Smartphone Integration using the **Devices** menu.

You can end Smartphone Integration via the **Devices** or by disconnecting the connecting cable between the mobile phone and multimedia system.

i Mercedes-Benz recommends disconnecting the connection via the device manager or the connecting cable only when the vehicle is stationary.

Overview of transferred vehicle data

When using Smartphone Integration, certain vehicle data is transferred to the mobile phone. This

enables you to get the best out of selected mobile phone services. Vehicle data is not directly accessible.

The following system information is transmitted:

- Software release of the multimedia system
- System ID (anonymized)

The transfer of this data is used to optimize communication between the vehicle and the mobile phone.

To do this, and to assign several vehicles to the mobile phone, a vehicle identifier is randomly generated.

This has no connection to the vehicle identification number (VIN) and is deleted when the multimedia system is reset (→ page 336).

The following driving status data is transmitted:

- Transmission position engaged
- Distinction between parked, standstill, rolling and driving
- Day/night mode of the driver's display
- Drive type

The transfer of this data is used to alter how content is displayed to correspond to the driving situation.

The following position data is transmitted:

- Coordinates
- speed
- Compass direction
- Acceleration direction

The mobile phone uses this data to improve the accuracy of navigation, for example, when driving through a tunnel.

Mercedes-Benz emergency call system

Information on the Mercedes-Benz emergency call system

Your vehicle is equipped with the Mercedes-Benz emergency call system ("eCall"). This feature can help save lives in the event of an accident. eCall in no way replaces assistance provided from dialing 911.

Mercedes-Benz eCall only functions in areas where mobile phone coverage is available from

the wireless service providers. Insufficient network coverage from the wireless service providers may result in an emergency call not being transmitted.

eCall is a standard feature in your Mercedes-Benz vehicle. In order to function as intended, the system relies on the transmission of data detailed in the Transmitted Data section that follows.

To disable eCall, a customer must visit an authorized Mercedes-Benz Service department to deactivate the vehicle's communication module.

Deactivation of this module prevents the activation of any and all Mercedes me connect services. After the deactivation of eCall, automatic emergency call and manual emergency call will not be available.

The vehicle must be switched on before an automatic emergency call can be made.

- ① eCall is activated at the factory.
- ① eCall can be deactivated by an authorized Mercedes-Benz dealer. Please note that in the event ownership of the vehicle is transferred to another owner in its deactivated state, eCall will remain deactivated unless the new

owner visits an authorized Mercedes-Benz dealership to reactivate the system.

Overview of the Mercedes-Benz emergency call system

eCall can help to reduce the time between an accident and the arrival of emergency services at the site of the accident. It helps locate an accident site in places that are difficult to access. However, even if a vehicle is equipped with eCall, this does not mean the system is ON. As such, eCall does not replace dialing 911 in the event of an accident.

An emergency call can be made automatically or manually.

Only make emergency calls if you or others are in need of rescue. Do not make an emergency call in the event of a breakdown or a similar situation.

Messages on the display

SOS NOT READY: the vehicle is not on or eCall not available.

During an active emergency call, <schar> appears in the display.

You can find more information on the regional availability of eCall at: <https://www.mercedes-benz-mobile.com/extra/ecall/>

i If there is a malfunction of the emergency call system, the loudspeakers, microphone, air bag or the SOS button, for example, are faulty.

You can recognize a malfunction in the emergency call system by the following displays:

- A corresponding message will also appear in the driver's display.
- The SOS button lights up red continuously.

Triggering an automatic Mercedes-Benz emergency call

Requirements:

- The vehicle is switched on.
- The starter battery is sufficiently charged.

The Mercedes-Benz emergency call system triggers an emergency call automatically in the following cases:

- After activation of the restraint systems such as air bags or Emergency Tensioning Devices after an accident
- After an automatically initiated emergency stop by Active Emergency Stop Assist

The emergency call has been made:

- A voice connection is made to the Mercedes-Benz emergency call center.
- A message with accident data is transmitted to the Mercedes-Benz emergency call center.

The Mercedes-Benz emergency call center can transmit the vehicle position data to one of the emergency call centers.

The SOS button in the overhead control panel flashes until the emergency call is finished.

It is not possible to immediately end an automatic emergency call.

If no connection can be made to the emergency services either, a corresponding message appears in the media display.

▶ Dial the local emergency number on your mobile phone.

If an emergency call has been initiated:

- Remain in the vehicle if the road and traffic conditions permit you to do so until a voice connection is established with the emergency call center operator.
- Based on the call, the operator decides whether it is necessary to call rescue teams and/or the police to the accident site.
- If no vehicle occupant answers, an ambulance is sent to the vehicle immediately.

Triggering a manual Mercedes-Benz emergency call

▶ **To use the SOS button in the overhead control panel:** press the SOS button at least one second long (→ page 353).

or

▶ **To use voice control:** use the voice commands of the MBUX Voice Assistant.

The emergency call has been made:

- A voice connection is made to the Mercedes-Benz emergency call center.
- A message with accident data is transmitted to the Mercedes-Benz emergency call center.

The Mercedes-Benz emergency call center can transmit the vehicle position data to one of the emergency call centers.

- Remain in the vehicle if the road and traffic conditions permit you to do so until a voice connection is established with the emergency call center operator.
- Based on the call, the operator decides whether it is necessary to call rescue teams and/or the police to the accident site.

If no connection can be made to the emergency services, a corresponding message appears in the central display.

▶ Dial the local emergency number on your mobile phone.

Ending an unintentionally triggered manual Mercedes-Benz emergency call

▶ Select <schar> on the multifunction steering wheel. Depress button for several seconds.

Data transfer of the Mercedes-Benz emergency call system

In the event of an automatic or manual emergency call the following data is transmitted, for example:

- Vehicle's GPS position data
- GPS position data on the route (a few hundred meters () before the incident)
- Direction of travel
- Vehicle identification number
- Vehicle drive type
- Number of people detected in the vehicle
- Whether Mercedes me connect is available or not
- Whether the emergency call was initiated manually or automatically
- Time of the accident
- Language setting on the multimedia system

Data transmitted is vehicle information. For any questions about the collection, use and sharing of the eCall system data, please contact MBUSA's Customer Assistance Center at 800-FOR-MERC.

For Canada, please contact MBC's Customer Assistance Center at 1-800-387-0100.









Customer requests for covered information should be submitted via the same channels.





For accident clarification purposes, the following measures can be taken up to an hour after the emergency call has been initiated:

- The current vehicle position can be determined.
- A voice connection to the vehicle occupants can be established.

Radio & media

Overview of the symbols and functions in the media menu







Symbol	Designation	Function
	Play	Select to start or continue playback.
	Rest	Select to pause the playback.
	Repeat a track	Select to repeat the current track or the active playlist. <ul style="list-style-type: none"> • Select once: the active playlist is repeated. • Select twice: the current track is repeated. • Select three times: the function is deactivated.
	Random playback	Select to play back the tracks in random order.
	Skip forwards/back	Select to skip to the next or to the previous track.
	Additional options	Select to show additional options.
	Categories	Select to show and search through available categories such as playback lists, albums or artists.
	Search	Select to search in the active menu. You can search for artists, genres or moods, for example.

Symbol	Designation	Function
	Settings	Select to make settings.
	Home	Select to return to the home screen.
	Messaging	Select to call up messaging.
	Full screen	Select to switch to full screen mode.

The following functions and settings are available in the **Media** menu:





- Connecting external data storage media with the multimedia system (e.g. using USB or Bluetooth®)
- Playing back audio or video files

Overview of the symbols and functions in the radio menu

Symbol	Designation	Function
	Home	Select to return to the home screen.
	Messaging	Select to call up messaging.
	Skip forwards/back	Select to skip to the next or to the previous station.
	Settings	Select to have further options shown. The setting options are country-dependent.
HD	HD radio™	Select to switch the HD Radio™ function on or off. This function is not available in all countries.
	Station list	Select to have the station list shown.
	Search	Select to search in the active menu. You can search for artists, genres or moods, for example.

Additional functions of TuneIn Radio

-  A relatively large volume of data can be transmitted when using TuneIn Radio.

Symbol	Designation	Function
	Settings	The following additional settings are available in the TuneIn Radio menu: <ul style="list-style-type: none"> • Selecting stream • Logging on to or out of the TuneIn account
	Favorites	Select during playback to save the station currently set as a favorite.
	Play/Pause	Select to start, stop or continue playback.
	Browse	Select to choose a category and then a radio station.



Additional functions of the satellite radio

SIRIUS XM[®] satellite radio offers more than 175 digital-quality radio channels providing commercial-free music, sports, news and entertainment, for example. SIRIUS XM[®] satellite radio employs a fleet of high-performance satellites to broadcast

around the clock throughout the USA and Canada. The satellite radio program is available for a monthly fee. Information about this can be obtained from a Sirius XM[®] Service Center and at <https://www.siriusxm.com> (USA).

 Sirius, XM and all related marks and logos are trademarks of Sirius XM Radio Inc. and its subsidiaries. All other marks, channel names

and logos are the property of their respective owners. All rights reserved.

Symbol	Designation	Function
	Settings	The following additional settings are available in the satellite radio menu: <ul style="list-style-type: none"> • Activate child safety lock to lock channels with adult content • Set alarm program for music and sport alerts • Create TuneMix lists to listen to music seamlessly
	Play	Select to start or continue playback.
	Rest	Select to pause the playback.

Depending on the frequency band selected, different functions are available to you.

Select the desired frequency band in the radio menu head runner.

Calling up TuneIn Radio

Requirements:

- There is a user account at <https://www.mercedes.me>.

- The vehicle is linked to the Mercedes me user account.
- The TuneIn Radio service is activated in the Mercedes me portal.
- The data volume is available.
Depending on the country, data volume may need to be purchased.
- A fast Internet connection for data transmission free of interference.

- ① New data volume can be purchased **directly from a mobile phone network provider** via the Mercedes me Portal.
- ① The functions and services are country-dependent. For more information, consult an authorized Mercedes-Benz Center.

Multimedia system:

→  ▶▶ Radio

- ▶ Select **TuneIn Radio**.
The TuneIn menu appears. The last station set starts playing.
- ⓘ The connection quality depends on the local mobile phone reception.

Setting up satellite radio

Requirements:

- Satellite radio equipment is available.
- Registration with a satellite radio provider has been completed.
- If registration is not included when purchasing the system, your credit card details will be required to activate your account.

Multimedia system:

→  ▶▶  Radio ▶▶ SiriusXM

▶▶ 

- ▶ Select **Service Information**.
The service information screen appears showing the radio ID and the current subscription status.
- ▶ Establish a telephone connection.
- ▶ Follow the service staff's instructions.
The activation process may take up to ten minutes.
- ⓘ You can also have the satellite service activated online. To do so, please visit <https://www.siriusxm.com> (USA) or <https://www.siriusxm.ca> (Canada).

Music and sport alerts

Multimedia system:

→  ▶▶  Radio ▶▶ SiriusXM

▶▶ 

Setting music and sport alerts

This function enables you to program an alert for your favorite artists, tracks or sporting events. Music alerts can be saved whilst a track is being played and sport alerts can be saved during a live game. You can also specify sport alerts via the menu option. The system then continuously searches through all the channels.

- ▶ Set a music or sports alert, to be informed of matches in the live program.

Activating messages for a category

- ▶ Select a category and activate .

Adding messages for a category

- ▶ Select a category and add a message .
- ▶ Select **Artist Alerts** or **Song Alerts** in the dialog window.
The message is set for the activated track and artist. If a match is found, a prompt

appears asking whether you wish to change to the station.

- Automatic adjustment

Deleting messages in a category

▶ Select a category, mark the desired messages and delete .

or

▶ Do not mark any messages and delete all entries .

Sound settings

Overview of functions in the sound menu

The setting options and functions available depend on the sound system installed. You can find out which sound system is installed in your vehicle in the Digital Operator's Manual.

Standard sound system

The following functions are available:

- Equalizer
 - Treble, mid-range and bass
- Balance and fader
- Volume

ASSYST PLUS service interval display

Function of the ASSYST PLUS service interval display

The ASSYST PLUS service interval display on the driver's display provides information on the remaining time or distance before the next service due date.

You can hide this service display using the  back button on the steering wheel.

Depending on how the vehicle is used, the ASSYST PLUS service interval display may shorten the service interval, e.g. in the following cases:

- Mainly short-distance driving
- When the engine is often left idling for long periods
- In the event of frequent cold start phases

Mercedes-Benz recommends avoiding such operating conditions.

You can obtain information concerning the servicing of your vehicle from a qualified specialist workshop, e.g. an authorized Mercedes-Benz Center.

Displaying the service due date

Driver's display:



The next service due date is displayed.

▶ **To exit the display:** press the  back button on the steering wheel.

Bear in mind the following related topic:

- Operating the driver's display (→ page 306).

Information on regular maintenance work

! **NOTE** Premature wear through failure to observe service due dates

Maintenance work which is not carried out at the right time or incompletely can lead to increased wear and damage to the vehicle.

- ▶ Adhere to the prescribed service intervals.
- ▶ Always have the prescribed maintenance work carried out at a qualified specialist workshop.

Notes on special service requirements

The prescribed service interval is based on normal operation of the vehicle. Have the maintenance work carried out more often than prescribed if operating conditions are difficult or the vehicle is subject to increased stress.

The ASSYST PLUS service interval display is only an aid. It is the responsibility of the driver of the vehicle to have maintenance work carried out more often than prescribed due to actual operating conditions and/or stresses.

Examples of arduous operating conditions:

- Regular city driving with frequent intermediate stops
- Mainly short-distance driving
- Frequent operation in mountainous terrain or on poor road surfaces
- When the engine is often left idling for long periods
- Operation in particularly dusty conditions and/or if air-recirculation mode is frequently used

In these or similar operating conditions, have the interior air filter, air filter, engine oil and oil filter, for example, changed more frequently. If subject to increased stress, check the tires more. Further information can be obtained at a qualified specialist workshop.

Battery disconnection periods

The ASSYST PLUS service interval display can calculate the service due date only when the battery is connected.

- ▶ Display and note down the service due date on the driver's display before disconnecting the battery (→ page 370).

Maintenance Management

Notes about Maintenance Management

If the Maintenance Management service is activated, relevant data is automatically transferred to the Mercedes-Benz customer center.

The customer center transmits the data to the service partner that you have entered on the

Mercedes me website at: <http://www.mercedes.me>. You will then receive individual recommendations regarding the maintenance of your vehicle.

- ① The calculation of the optimal transmission time of the maintenance request to the service partner is subject to technical limitations that may cause the maintenance recommendation to be perceived as too early or too late or not to be made at all. In this case, you can conveniently arrange a maintenance appointment with the customer center via the maintenance reminder in the multimedia system.
- ① Maintenance Management and the maintenance reminder in the multimedia system are not available in every country. Contact an authorized Mercedes-Benz Center to find out whether this function is available in your country.

Data transferred when using Maintenance Management

When the service is activated, relevant data is automatically transferred to determine the required scope of maintenance as well as malfunction detection and malfunction rectification.

Details on data transfer can be found in the data protection information for the Mercedes me connect services. These can be found at: <https://www.mercedes.me> under "My Mercedes me account", "Terms of use".

- ① Maintenance Management and the maintenance reminder in the multimedia system are not available in every country.

Telediagnosis

Notes about Telediagnosis

- ① This service is not available in all countries. The vehicle can detect if certain wear parts need to be replaced or if malfunctions have occurred in vehicle systems. If the Telediagnosis service is activated, relevant data is automatically transmitted to the manufacturer. If fault conditions are

detected by the vehicle system self-diagnosis, the system transmits recommendations for action to the Mercedes-Benz customer center depending on the fault detected. The customer center transmits the data to the service partner that you have entered on the Mercedes me website at: <http://www.mercedes.me>.

For selected faults, the notification that a malfunction has been detected may appear in the multimedia system with a request to contact the Mercedes-Benz customer center. From this message, a call can be made directly to the customer center for assistance.

- ① The transmission of a notification to the multimedia system depends on the country, vehicle model and equipment and requires a fast data connection, over which the service provider has no influence.
- ① Reliable fault detection is subject to technical limitations. Therefore, only a limited selection of faults can be detected and recommendations for action transmitted to the customer center and the service partners. Mercedes-Benz AG is continuously working on the expansion of this service. The fault detection

depends on the country, vehicle model and equipment.

Data transferred when using Telediagnosics

When the service is activated, relevant data is automatically transferred to determine the required scope of maintenance as well as malfunction detection and malfunction rectification.

Details on data transfer can be found in the data protection information for the Mercedes me connect services. These can be found at: <https://www.mercedes.me> under "My Mercedes me account", "Terms of use".

- ① The scope of the data transmitted depends on the vehicle model and equipment. For technical reasons, not all data is available at all times.

Engine compartment

Opening and closing the hood

⚠ DANGER Risk of fatal injuries when carrying out maintenance work during the charging process

During the charging process, the high-voltage on-board electrical system is under high voltage.

- ▶ Do not perform any maintenance work during the charging process.

⚠ WARNING Risk of accident due to driving with the hood unlocked

The hood may open and block your view.

- ▶ Never release the hood when driving.
- ▶ Before every trip, ensure that the hood is locked.

⚠ WARNING Risk of accident and injury when opening and closing the hood

The hood may suddenly drop into the end position.

There is a risk of injury for anyone in the hood's range of movement.

- ▶ Do not open or close the hood if there is a person in the hood's range of movement.

⚠ WARNING Risk of burns when opening the hood

If you open the hood in the event of an overheated engine or fire in the engine compartment, the following situations may occur:

- You may come into contact with hot gases.
 - You may come into contact with other escaping hot operating fluids.
- ▶ Before opening the hood, allow the engine to cool down.

- ▶ In the event of a fire in the engine compartment, keep the hood closed and call the fire service.

⚠ WARNING Risk of injury due to moving parts

Components in the engine compartment may continue to run or start unexpectedly even when the drive system is switched off.

Observe the following if you must open the hood:

- ▶ Switch off the vehicle.
- ▶ Never touch the danger zones surrounding moving components, e.g. the rotation area of the fan.
- ▶ Remove jewellery and watches.
- ▶ Keep items of clothing and hair away from moving parts.

⚠ WARNING Risk of injury from touching live components

The ignition system and the fuel injection system operate with a high voltage. You could receive an electric shock.

- ▶ Never touch components of the ignition system or fuel injection system when the vehicle is switched on.

The live components include the following, for example:

- Ignition coils
- Fuel injectors
- Electric lines to the ignition coils and the fuel injectors

⚠ WARNING Risk of burns from hot component parts in the engine compartment

Certain component parts in the engine compartment can be very hot, e.g. the engine, the cooler and parts of the exhaust system.

- ▶ Allow the engine to cool down and only touch component parts described in the following.

⚠ WARNING Risk of injury from using the windshield wipers when the hood is open

If the windshield wipers start moving when the hood is open, you could be trapped by the wiper linkage.

- ▶ Always switch off the windshield wipers and the vehicle first if you need to open the hood.

Opening the hood

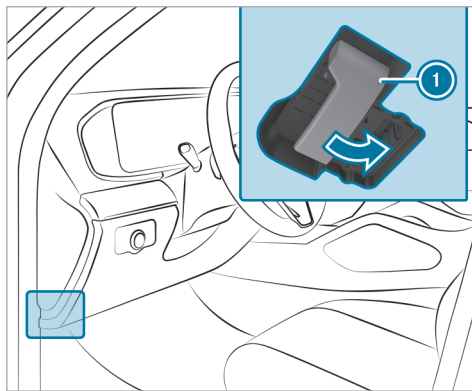

- ▶ To release the hood, pull on handle ①.

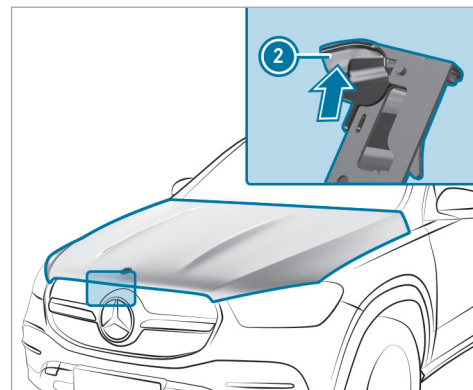

- ▶ Push handle ② of the hood catch upwards and lift the hood until it opens automatically.

Closing the hood

! **NOTE** Damage to the hood

If the hood is closed manually, there is a risk of dents.

- ▶ Do not close the hood manually.

- ▶ Lower the hood to a height of around 8 in (20 cm) and then allow it to fall, applying a little force as you let it go.
- ▶ If the hood can still be lifted slightly, open the hood again and close it with a little more force until it engages correctly.

Engine oil

■ Checking the engine oil level using the driver's display

Requirements:

- The engine has been warmed up.
- The vehicle is parked on a level surface.
- The engine is running at idle speed.
- The hood is closed.

Determining the engine oil level can take up to 30 minutes with a normal driving style and even longer with an active driving style.

Driver's display:



The engine oil level is shown.

One of the following messages will appear on the driver's display:

- **Engine Oil Level Measuring Now...**: the engine oil level cannot be determined yet.
- ▶ Repeat the request after a maximum of 30 minutes' driving.
- **Engine Oil Level OK** and the bar display for indicating the engine oil level on the driver's display is green and is between "min" and "max": the engine oil level is correct.
- **Engine Oil Level Refill 1,0 liq.gal.** and the bar display for indicating the engine oil level on the driver's display is yellow and is below "min":
- ▶ Add 1.1 US qt (1 l) of engine oil.
- **Engine Oil Level Reduce** and the bar display for indicating the engine oil level on the driver's display is yellow and is above "max":
- ▶ Drain off any excess engine oil that has been added. To do so, consult a qualified specialist workshop.
- **For Engine Oil Level Switch on Vehicle**

- ▶ Switch on the vehicle to check the engine oil level.
- **Engine Oil Level System Inoperative**: The oil level sensor is defective or not connected.
- ▶ Consult a qualified specialist workshop.
- **Engine Oil Level System Currently Unavailable**
- ▶ Close the hood.

■ Refilling engine oil

⚠ WARNING Risk of burns from hot component parts in the engine compartment

Certain component parts in the engine compartment can be very hot, e.g. the engine, the cooler and parts of the exhaust system.

- ▶ Allow the engine to cool down and only touch component parts described in the following.

⚠ WARNING Risk of fire and injury from engine oil

If engine oil comes into contact with hot component parts in the engine compartment, it may ignite.

- ▶ Make sure that no engine oil is spilled next to the filler opening.
- ▶ Allow the engine to cool off and thoroughly clean the engine oil from component parts before starting the vehicle.

! NOTE Engine damage caused by an incorrect oil filter, incorrect oil or additives

- ▶ Do not use engine oils or oil filters which do not correspond to the specifications explicitly prescribed for the service intervals.
- ▶ Follow the instructions on the service interval display for changing the engine oil and observe the prescribed change intervals.
- ▶ Do not use additives.

! NOTE Damage caused by adding too much engine oil

Excessive engine oil can damage the engine or the catalytic converter.

- ▶ Have excess engine oil removed in a qualified specialist workshop.

- ① Depending on driving style, the vehicle consumes up to 0.9 US qt (0.8 liters) of oil per 600 miles (1,000 km). The oil consumption may also be higher than this when the vehicle is new or if you frequently drive at high engine speeds.
- ① Depending on the engine, the cap may be located in different positions in the engine compartment.

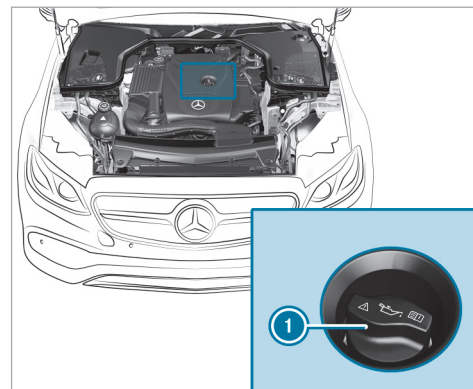

- ▶ Turn cap ① counter-clockwise and remove it.
- ▶ Refill engine oil.
- ▶ Replace cap ① and turn it clockwise until it engages.
- ▶ Check the oil level again (→ page 375).

Checking the coolant level

⚠ WARNING Risk of burns from hot component parts in the engine compartment

Certain component parts in the engine compartment can be very hot, e.g. the engine, the cooler and parts of the exhaust system.

▶ Allow the engine to cool down and only touch component parts described in the following.

⚠ WARNING Risk of scalding from hot coolant

If you open the cap, you could be scalded.

- ▶ Let the motor cool down before opening the cap.
- ▶ When opening the cap, wear protective gloves and safety glasses.
- ▶ Open the cap slowly to release pressure.

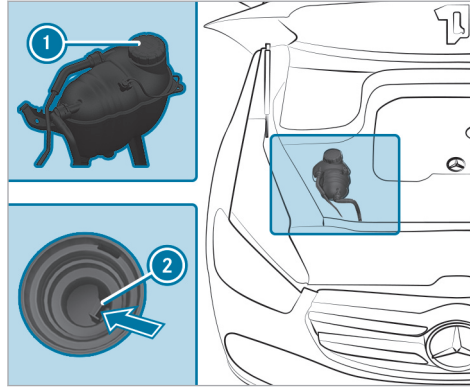

- ▶ Park the vehicle on a level surface.
- ▶ Check the coolant temperature display on the driver's display. The coolant temperature must be in the bottom quarter of the temperature indicator.
- ▶ Slowly turn cap ① counter-clockwise to release overpressure.

- ▶ Continue turning cap ① counter-clockwise and remove it.

The coolant level is correct in the following cases:

- If the engine is cold, the coolant is up to marker bar ②.
- If the engine is warm, the coolant is up to 0.6 in (1.5 cm) over the marker bar ②.
- ▶ If necessary, refill with coolant that has been approved for Mercedes-Benz.
- ① Further information on coolant (→ page 457).

Refilling the windshield washer system

⚠ WARNING Risk of burns from hot component parts in the engine compartment

Certain component parts in the engine compartment can be very hot, e.g. the engine, the cooler and parts of the exhaust system.

▶ Allow the engine to cool down and only touch component parts described in the following.

⚠ WARNING – Risk of fire and injury from windshield washer concentrate

Windshield washer concentrate is highly flammable. It could ignite if it comes into contact with hot engine component parts or the exhaust system.

- ▶ Make sure that no windshield washer concentrate spills out next to the filler opening.

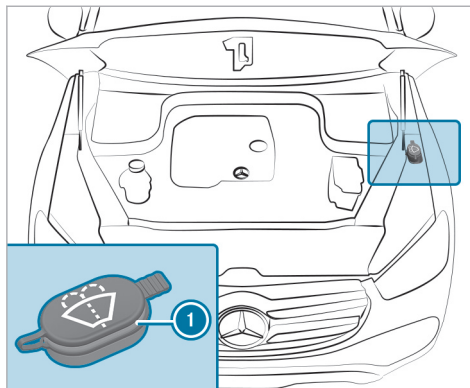

- ▶ Remove cap ❶ by the tab.
- ▶ Add washer fluid.
- ❶ Further information about the windshield washer fluid (→ page 458).

Keeping the air/water duct free

- ▶ Keep the area between the hood and the windshield free of deposits, e.g. ice, snow or leaves.

Cleaning and care

Information on washing the vehicle in a car wash

⚠ WARNING Risk of accident due to reduced braking effect after washing the vehicle

The braking effect is reduced after washing the vehicle.

- ▶ After the vehicle has been washed, brake carefully while paying attention to the traffic conditions until the braking effect has been fully restored.

! NOTE Damage from automatic braking

If one of the following functions is activated, the vehicle will brake automatically in certain situations:

- Active Brake Assist
- Active Distance Assist DISTRONIC
- HOLD function
- Active Parking Assist

To avoid damage to the vehicle, deactivate these systems in the following or similar situations:

- ▶ During towing.
- ▶ In a car wash.

! NOTE Damage due to unsuitable car wash

▶ Before driving into a car wash make sure that the car wash is suitable for the vehicle dimensions.

- ▶ Ensure there is sufficient ground clearance between the underbody and the guide rails of the car wash.
- ▶ Ensure that the clearance width of the car wash, in particular the width of the guide rails, is sufficient.

To avoid damage to your vehicle when using a car wash, ensure the following beforehand:

- Active Distance Assist DISTRONIC is deactivated.
- The HOLD function is switched off.
- The 360° camera or the reversing camera is switched off.
- The side windows and sliding sunroof are completely closed.
- The outside mirrors are folded in.
- The blower for the ventilation and heating is switched off.
- The windshield wiper switch is in position **0**.
- The key is at a minimum distance of 10 ft (3 m) away from the vehicle. Otherwise, the tailgate could open unintentionally.

- For car washes with a conveyor system:
 - Neutral **N** is engaged.
 - If you would like to leave the vehicle while it is being washed, make sure the key is located in the vehicle. Park position **P** will otherwise be engaged automatically.
- ⓘ To prevent damage to the tires or rims, drive straight and into the center of the guide rails of the car wash.
- ⓘ If, after the car wash, you remove the wax from the windshield and wiper rubbers, this will prevent smearing and reduce wiper noise.

Automatic car wash mode

In car wash mode, the vehicle is prepared for driving into an automatic car wash. Car wash mode can be activated at a speed of up to 12 mph (20 km/h) (→ page 380).

The following settings are adjusted when car wash mode is activated:

- The outside mirrors will be folded in.
- To prevent the windshield washer system from starting up automatically, the rain sensor will be deactivated.

- The rear window wiper will be deactivated.
- The air conditioning system will be set to air-recirculation mode.
- Parking Assist PARKTRONIC will be deactivated.
- **Vehicles with 360° camera:** The front image will be activated after approximately eight seconds.

- **Vehicles with AIRMATIC:** The vehicle will be raised to the maximum possible chassis level (→ page 268).

If raising takes longer than 25 seconds, the following message will appear on the driver's display:

[Preparation for Automatic Car Wash Incomplete See Central Display](#). After some time, the vehicle will automatically continue being raised.

- **Vehicles with E-ACTIVE BODY CONTROL:** The vehicle will be raised to the maximum possible chassis level (→ page 276).

If raising takes longer than 25 seconds, the following message will appear on the driver's display:

[Preparation for Automatic Car Wash Incomplete See Central Display](#). After some time, the vehicle will automatically continue being raised.

If one of the settings cannot be selected, this will be shown by the  symbol next to the respective setting.

Above a speed of 12 mph (20 km/h), car wash mode will be deactivated automatically.

The following settings will be reset when car wash mode is deactivated:

- The outside mirrors will be folded out.
- The rain sensor will be activated.
- The rear window wiper will be activated.
- The air conditioning system will be set to fresh air mode.
- Parking Assist PARKTRONIC will be reset to the previously selected setting.

- **Vehicles with 360° camera:** The front image will be deactivated at speeds above 11 mph (18 km/h).
- **Vehicles with AIRMATIC:** The vehicle will be lowered to the previously set chassis level.
- **Vehicles with E-ACTIVE BODY CONTROL:** The vehicle will be lowered to the previously set chassis level.

[Activating/deactivating automatic car wash mode](#)

Requirements

- The vehicle is stationary.
- The vehicle is switched on.

Multimedia system:

 [Settings](#) [Vehicle](#) [Driving](#)

Activating automatic car wash mode

- ▶ Select [Automatic Car Wash Mode](#).
- ▶ Select [Activate](#).

If one of the settings cannot be selected, this is shown by a  next to the respective setting.

- ⓘ For an overview of the settings made when activating automatic car wash mode (→ page 378).

Deactivating automatic car wash mode

- ▶ Select **Switch Off**.
The automatic car wash settings are reset.
- ⓘ The automatic car wash mode is automatically deactivated as soon as a speed of 12 mph (20 km/h) is exceeded.

Information on using a power washer

⚠ WARNING Risk of an accident when using power washers with round-spray nozzles

The water jet can cause externally invisible damage.

Components damaged in this way may unexpectedly fail.

- ▶ Do not use a power washer with round-spray nozzles.
- ▶ Have damaged tires or chassis parts replaced immediately.

To avoid damage to your vehicle when using a power washer, ensure the following:

- The key is at a minimum distance of 10 ft (3 m) away from the vehicle. Otherwise, the tailgate could open unintentionally.
- Keep a minimum distance of 11.8 in (30 cm) from the vehicle.
- **Vehicles with decorative foil:** parts of your vehicle are covered with decorative foil. Maintain a minimum distance of at least 27.6 in (70 cm) between the foiled parts of the vehicle and the nozzle of power washer. Move the power washer nozzle around when cleaning your vehicle. The water temperature of the power washer must not exceed 140 °F (60 °C).
- Observe the information on the correct distance in the operating instructions of the equipment manufacturer.
- Do not point the nozzle of the power washer directly at any sensitive parts, e.g. tires, gaps, electrical components, batteries, illuminants or louvers.

Washing the vehicle by hand

! NOTE Engine damage due to water ingress

- ▶ Take care not to point the water jet directly towards the air inlet grille below the hood.

Observe the relevant legal requirements (e.g. in some countries, washing by hand is permitted only in specially designated wash bays).

- ▶ Use a mild cleaning agent (e.g. car shampoo).
- ▶ Wash the vehicle with lukewarm water using a soft car sponge. When doing so, do not expose the vehicle to direct sunlight.
- ▶ Carefully hose the vehicle off with water and dry using a chamois.
- ⓘ Observe the notes on the care of car parts (→ page 383).

Notes on paintwork/matt finish paintwork care

To avoid damaging the paintwork and interfering with the driving assistance systems, please observe the following notes:

Paint

- Insect remains: soak with insect remover and rinse off the treated areas afterwards.
- Bird droppings: soak with water and rinse off afterwards.
- Tree resin, oils, fuels and greases: remove by rubbing gently with a cloth soaked in petroleum ether or lighter fluid.
- Coolant and brake fluid: remove with a damp cloth and clean water.
- Tar stains: use tar remover.
- Wax: use silicone remover.
- Do not attach stickers, films or similar materials. Have film attached to the bumper only at a qualified specialist workshop.
- Remove dirt immediately, where possible.

Matt finish

- Use only care products approved for Mercedes-Benz.
- Do not attach stickers, films or similar materials. Have film attached to the bumper only at a qualified specialist workshop.

- Do not polish the vehicle and alloy wheels.
- Use only car washes that correspond to the latest engineering standards.
- Do not use any car wash program with a final hot wax treatment.
- Do not use paint cleaners, buffing or polishing products or gloss preservers, e.g. wax.

In the event of paintwork damage:

- Always have paintwork repairs carried out at a qualified specialist workshop.
- Make sure the radar sensors function (→ page 228).

Notes on cleaning decorative films

Observe the "Notes on paintwork/matte finish paintwork care" (→ page 381). They also apply to matte decorative films.

Observe the notes on cleaning decorative films to avoid damage.

Cleaning

- For cleaning, use plenty of water and a mild cleaning agent without additives or abrasive

substances (e.g. a car shampoo approved for Mercedes-Benz).

- Remove dirt as soon as possible. Avoid rubbing too hard in order not to damage the decorative film irreparably.
- If there is dirt on the finish or if the decorative film is dull: use the paint cleaner recommended and approved for Mercedes-Benz.
- Insect remains: soak with insect remover and rinse off the treated areas afterwards.
- Bird droppings: soak with water and rinse off afterwards.
- To prevent water stains, dry a film-wrapped vehicle with a soft, absorbent cloth after every car wash.

Avoiding damage to the decorative film

- The service life and color of decorative films are impaired by:
 - Sunlight
 - Temperature (e.g. hot air blower)
 - Weather conditions
 - Stone chippings and dirt

- Chemical cleaning agents
- Oily products
- Do not use polish on matte decorative film. Polishing will have the effect of shining the film-wrapped surface.
- Do not treat matte or structured decorative films with wax. Permanent stains may occur.

Scratches, corrosive deposits, areas affected by corrosion and damage caused by incorrect care cannot always be completely repaired. In this case, contact a qualified specialist workshop.

You can obtain more information on care and cleaning agents from the manufacturer.

In the case of film-wrapped surfaces, visual differences may occur between the surfaces that were not protected by a decorative film after a decorative film has been removed.

- ① Have work or repairs to decorative films carried out at a qualified specialist workshop (e.g. at an authorized Mercedes-Benz Center).

Notes on care of car parts

⚠ WARNING Risk of entrapment if the windshield wipers are switched on while the windshield is being cleaned

If the windshield wipers are set in motion while you are cleaning the windshield or wiper blades, you can be trapped by the wiper arm.

- ▶ Always switch off the windshield wipers and the vehicle before cleaning the windshield or wiper blades.

To avoid damage to the vehicle, observe the notes on cleaning and care of the following car parts:

Wheels and rims

- Use water and acid-free alloy wheel cleaners.
- Do not use acidic alloy wheel cleaners to remove brake dust. This could damage wheel bolts and brake components.
- To avoid corrosion of the brake discs and pads, drive the vehicle for a few minutes after cleaning before parking it. The brake discs and pads will warm up and dry out.

Windows

! NOTE Damage to electronic components due to excess fluids

When cleaning the windows from the inside, fluids such as cleaning agents or water may run down and get behind trim parts of the vehicle interior and cause damage to electronic components.

- ▶ Use cleaning agents as sparingly as possible.
- ▶ Immediately absorb any excess fluids.

- Clean the windows inside and outside with a damp cloth and with a cleaning agent recommended for Mercedes-Benz.
- Do not use dry cloths or abrasive or solvent-based cleaning agents to clean the insides of windows.

- ⓘ After changing the wiper blades or treating the vehicle with wax, clean the windshield thoroughly with cleaning agents recommended for Mercedes-Benz. Failure to observe the application instructions may result in damage, smear marks or glare spots.
- ⓘ Remove external fogging or dirt on the windshield in front of the multifunction camera. Otherwise, driving systems and driving safety systems may be impaired or unavailable (→ page 228).

Wiper blades

- Move the wiper arms into the replacement position (→ page 148).
- With the wiper arms folded out, clean the wiper blades with a damp cloth.
- ⓘ Make sure that the wiper blades are coated. The coating may leave residue on a cloth. Do not rub the wiper blades excessively or clean them too often.

Exterior lighting

- Clean the lenses with a wet sponge and mild cleaning agent (e.g. car shampoo).

- Use only cleaning agents or cleaning cloths that are suitable for plastic lenses.

Vehicle socket (high-voltage battery)

- Use clean water and a soft cloth to clean the vehicle socket.
- Do not use power washers or cleaning agents such as soap.

Sensors

- Clean the sensors in the front and rear bumpers with a soft cloth and car shampoo (→ page 228).
- When using a power washer, maintain a minimum distance of 11.8 in (30 cm).

Running boards

- Use water and acid-free cleaning agents.
- Do not clean the aluminum trim inserts of the running board with alkaline or acidic cleaning agents such as wheel cleaners. Do not use acidic alloy wheel cleaners to remove brake dust. The aluminum trim inserts could otherwise be damaged.

Reversing camera and 360° Camera

- Open the camera cover with the multimedia system (→ page 287).
- Use clean water and a soft cloth to clean the camera lens.
- Do not use a power washer.

Trailer hitch

- Observe the notes on care in the trailer hitch manufacturer's operating instructions.
- Do not clean the ball neck with a power washer or solvent.
- Remove traces of rust on the ball (e.g. using a wire brush).
- Remove dirt with a lint-free cloth.
- After cleaning, lightly oil or grease the ball head.
- ⓘ Before using trailers with anti-torsional coupling, observe the manufacturer's operating instructions.

Notes on care of the interior

▲ WARNING Risk of injury from plastic parts breaking off after the use of solvent-based care products

Care and cleaning products containing solvents can cause surfaces in the cockpit to become porous. When the airbags are deployed, plastic parts may break away.

- ▶ Do not use any care or cleaning products containing solvents to clean the cockpit.

▲ WARNING Risk of injury or fatal injuries from bleached seat belts

Bleaching or dyeing seat belts can severely weaken them.

This can, for example, cause seat belts to tear or fail in an accident.

- ▶ Never bleach or dye seat belts.

To avoid damage to the vehicle, observe the following notes on cleaning and care:

Seat belts

- Clean with lukewarm soapy water.
- Do not use chemical cleaning agents.
- Do not dry by heating them to over 176°F (80°C) or exposing them to direct sunlight.

Display

- Switch off the display and let it cool down.
- Clean the surface carefully with a microfiber cloth and a suitable display care product (TFT-LCD).
- Do not use any other agents.

Head-up display

- Clean with a soft, non-static, lint-free cloth.
- Do not use cleaning agents.

Plastic trim

- Clean with a damp microfiber cloth.
- For heavy soiling: use a cleaning agent recommended for Mercedes-Benz.
- Do not attach stickers, films or similar materials.

- Do not allow cosmetics, insect repellent or sun cream to come into contact with the plastic trim.

Real wood and trim elements

- Clean with a microfiber cloth.
- Black piano-lacquer look: clean with a damp cloth and soapy water.
- For heavy soiling: use a cleaning agent recommended for Mercedes-Benz.
- Do not use solvent-based cleaning agents, polishes or waxes.

Headliner

- Clean with a brush or dry shampoo.

Carpet

- Use a carpet and textile cleaning agent recommended for Mercedes-Benz.

Steering wheel made of genuine leather or DINAMICA

! **NOTE** Damage caused by wrong cleaners

- ▶ Do not use solvent-based cleaning agents such as tar remover or wheel

cleaner; neither should you use polishes or waxes. Otherwise you may damage the finish.

- Clean with a damp cloth and 1% soapy water solution and then wipe with a dry cloth.
- For heavy soiling: use a cleaning agent recommended for Mercedes-Benz.
- Leather care: use a leather care agent that has been recommended for Mercedes-Benz.
- Do not allow the leather to become too damp.
- Do not use a microfiber cloth.

i Leather is a natural product. It exhibits natural surface properties such as differences in structure, marks caused by growth and injury or subtle color differences. These surface properties are characteristics of leather and not material malfunctions. Leather is also subject to a natural aging process during which the surface properties change.

Genuine leather seat covers

- Vacuum up dirt such as crumbs or dust and then clean the seat covers with a damp cotton

cloth and wipe down with a dry cloth. Regularly clean the seat covers.

- For heavy soiling: use a leather care agent recommended for Mercedes-Benz aftercare.
- Leather care: use a leather care agent that has been recommended for Mercedes-Benz.
- Do not use a microfiber cloth.
- Do not allow the leather to become too damp.
- Do not use oil-based cleaning and care products.

i Leather is a natural product. It exhibits natural surface properties such as differences in structure, marks caused by growth and injury or subtle color differences. These surface properties are characteristics of leather and not material malfunctions. Leather is also subject to a natural aging process during which the surface properties change. Waves or wrinkling in the seat cover may occur due to the stress on the seat; this is caused by the natural leather material. Regular cleaning and care of the leather reduces soiling, wear marks and aging damage and thus significantly extends its life

span. Clothing that can leave stains (e.g. jeans) may discolor the leather.

DINAMICA seat covers

- Vacuum up dirt such as crumbs or dust and then use a damp cloth to clean.
- Do not use a microfiber cloth.

Imitation leather seat covers

- Vacuum up dirt such as crumbs or dust and then use a damp cotton cloth and a 1% soap solution to clean the entire seat cover. Do not spot clean.
- Use cleaning and care products recommended for Mercedes-Benz.
- Do not use a microfiber cloth.
- Do not use oil-based cleaning and care products.

Fabric seat covers

- Vacuum up dirt such as crumbs or dust and then use a damp microfiber cloth and a 1% soap solution to clean the entire seat cover. Do not spot clean.

- Use cleaning and care products recommended for Mercedes-Benz.
- Do not use oil-based cleaning and care products.

Emergency

Removing the safety vest

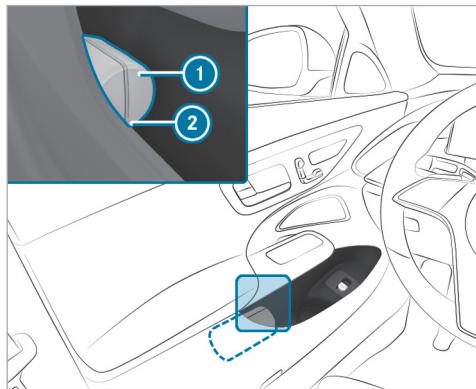

A compartment for storing safety vests can be found in the door stowage compartments on all the doors.

- ▶ To remove: pull out safety vest bag ① by loop ②.

- ▶ Open safety vest bag ① and take out the safety vest.
- ▶ To stow: fold the reflective safety vest, roll it up and stow it in safety vest bag ①.
- ▶ Slide safety vest bag ① along the lower edge of the armrest into the safety vest compartment. When doing so, ensure that loop ② hangs out well within reach.

- ⓘ Remove a new reflective safety vest from its packaging material before sliding it into the safety vest compartment. The packaging material may otherwise cause it to slip out or make removing it difficult. Observe the legal requirements in each country.

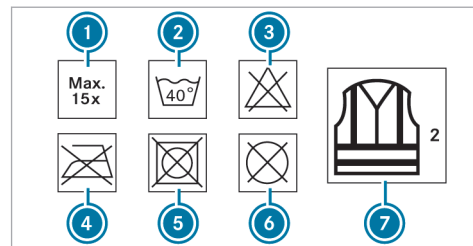

- ① Maximum number of washes
- ② Maximum wash temperature
- ③ Do not bleach
- ④ Do not iron
- ⑤ Do not tumble dry
- ⑥ Do not dry clean
- ⑦ Class 2 safety vest

The requirements defined by the legal standard are only fulfilled if the safety vest is the correct size and is fully closed.

Replace the safety vest in the following cases:

- The reflective strips are damaged or dirty

- The maximum permissible number of washes is exceeded
- The fluorescence has faded, e.g. due to continuous exposure to sunlight.

Dispose of the safety vest in an environmentally responsible manner.

- To do so, contact your local waste disposal company.

Warning triangle

■ Removing the warning triangle (not plug-in hybrid)

Vehicles with two rows of seats

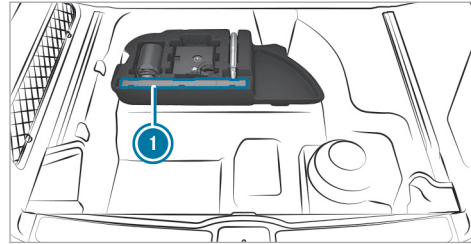

- ▶ Remove warning triangle ①.

Vehicles with three rows of seats

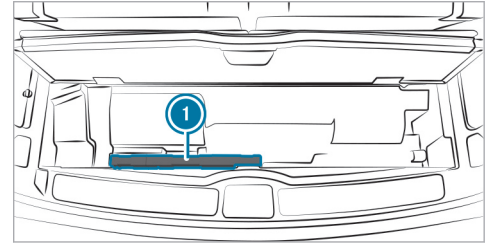

- ▶ Remove warning triangle ①.

■ Removing the warning triangle (plug-in hybrid)

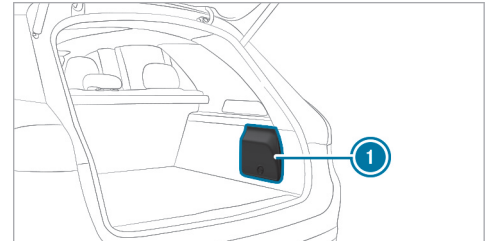

- ▶ The warning triangle is located in the cargo compartment on the right behind service flap ①.

Setting up the warning triangle

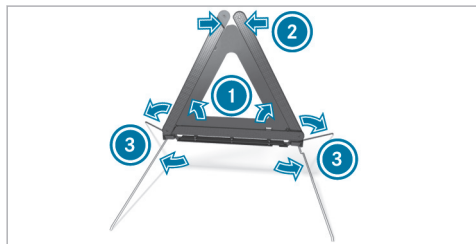

- ▶ Fold side reflectors ① upwards to form a triangle and attach at the top using upper press-stud ②.
- ▶ Fold legs ③ down and out to the side.

First-aid kit (soft-sided) overview

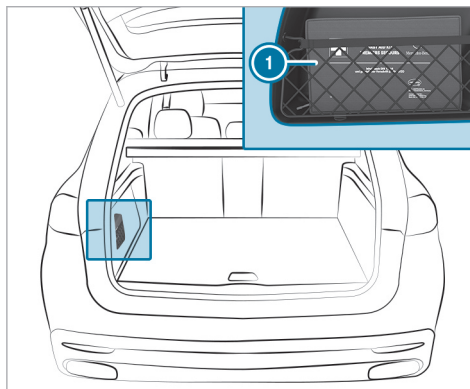

Depending on the vehicle equipment, the first-aid kit (soft-sided) may be located in the following places in the vehicle:

- The first-aid kit ① is in the stowage net in the cargo compartment on the left or right.
- **Plug-in-Hybrid:** The first-aid kit is in the door tray of the driver's door. (→ page 122)

Flat tire

Notes on flat tires

⚠ WARNING Risk of accident due to a flat tire

A flat tire severely affects the driving characteristics as well as the steering and braking of the vehicle.

Tires without run-flat characteristics:

- ▶ Do not drive with a flat tire.
- ▶ Change the flat tire immediately with an emergency spare wheel or spare wheel. Alternatively, consult a qualified specialist workshop.

Tires with run-flat characteristics:

- ▶ Observe the information and warning notes on MOExtended tires (run-flat tires).

In the event of a flat tire, the following options are available depending on your vehicle's equipment:

- **Vehicles with MOExtended tires:** it is possible to continue the journey for a short period of time. Make sure you observe the notes on MOExtended tires (run-flat tires) (→ page 391).
 - **Vehicles with a TIREFIT kit:** you can seal the tire so that it is possible to continue the journey for a short period of time. To do this, use the TIREFIT kit (→ page 393).
 - **Vehicles with Mercedes me connect:** you can make a call for breakdown assistance via the overhead control panel in the case of a breakdown (→ page 353).
 - **All vehicles:** change the wheel (→ page 438).
- i** The emergency spare wheel is only available in certain countries.

Notes on MOExtended tires (run-flat tires)

▲ WARNING Risk of accident when driving in limp-home mode

When driving in emergency mode the handling characteristics are impaired.

- ▶ Do not exceed the specified maximum speed of the MOExtended tires.
- ▶ Avoid any abrupt steering and driving maneuvers as well as driving over obstacles (curbs, pot holes, off-road). This applies, in particular, to a loaded vehicle.
- ▶ Stop driving in the emergency mode if you notice:
 - Banging noise
 - Vehicle vibration
 - Smoke which smells like rubber
 - Continuous ESP® intervention
 - Cracks in the tire side walls
- ▶ After driving in emergency mode, have the rims checked by a qualified specialist

workshop with regard to their further use.

- ▶ The defective tire must be replaced in every case.

With MOExtended tires (run-flat tires), you can continue to drive your vehicle even if there is a total loss of pressure in one or more tires. However, the tire affected must not show any clearly visible damage.

You can recognize MOExtended tires by the MOExtended marking which appears on the side wall of the tire.

Vehicles with tire pressure loss warning system: MOExtended tires may only be used in conjunction with an activated tire pressure loss warning system.

Vehicles with tire pressure monitoring system: MOExtended tires may only be used in conjunction with an activated tire pressure monitoring system.

If a pressure loss warning message appears in the driver's display, proceed as follows:

- Check the tire for damage.

- If driving on, observe the following notes.

Driving distance possible in emergency mode after the pressure loss warning:

Load condition	Driving distance possible in emergency mode
Partially laden	50 miles (80 km)
Fully laden	19 miles (30 km)

The driving distance possible in emergency mode may vary depending on the driving style. Observe the maximum permissible speed of 50 mph (80 km/h).

If a tire has gone flat and cannot be replaced with an MOExtended tire, you can use a standard tire as a temporary measure.

Storage location of the TIREFIT kit (not plug-in hybrid)

The TIREFIT kit is located under the cargo floor.

Vehicles with two rows of seats

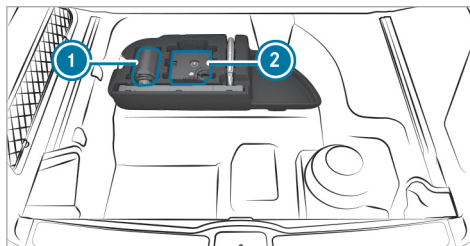

- ① Tire sealant bottle
- ② Tire inflation compressor

Vehicles with three rows of seats

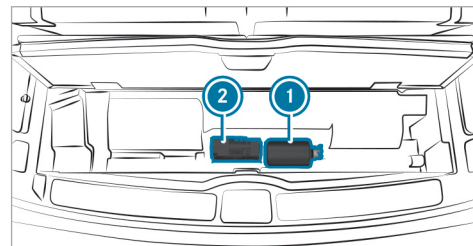

- ① Tire sealant bottle
- ② Tire inflation compressor

Depending on the vehicle version, the TIREFIT kit may be located in another position under the cargo floor.

Storage location of the TIREFIT Kit (plug-in hybrid)

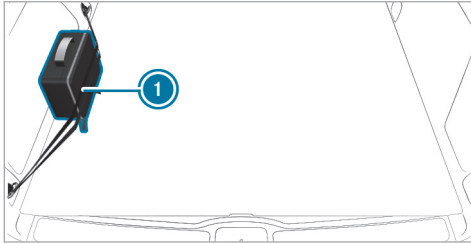

TIREFIT kit ① is located on the left-hand side of the cargo compartment. Observe the loading guidelines in the vehicle Operator's Manual.

Using the TIREFIT kit

Requirements

- Tire sealant bottle and tire inflator compressor are ready for use (→ page 392, 393).
- TIREFIT sticker is present.
- Gloves are present.

You can use TIREFIT tire sealant to seal perforation damage of up to 0.16 in (4 mm), particularly those in the tire tread. You can use TIREFIT in outside temperatures down to -4 °F (-20 °C).

⚠ WARNING Risk of accident when using tire sealant

The tire sealant may be unable to seal the tire properly, especially in the following cases:

- There are large cuts or punctures in the tire (larger than damage previously mentioned)
 - The wheel rims have been damaged
 - After journeys with very low tire pressure or with flat tires
- ▶ Do not continue driving.
 - ▶ Consult a qualified specialist workshop.

⚠ WARNING Risk of injury and poisoning from tire sealant

The tire sealant is harmful and causes irritation. Do not allow it to come into contact with

the skin, eyes or clothing, and do not swallow it. Do not inhale tire sealant fumes. Keep the tire sealant away from children.

If you come into contact with the tire sealant, observe the following:

- ▶ Rinse off the tire sealant from your skin immediately using water.
- ▶ If tire sealant gets into your eyes, thoroughly rinse out the eyes using clean water.
- ▶ If tire sealant has been swallowed, immediately rinse out the mouth thoroughly and drink plenty of water. Do not induce vomiting and seek medical attention immediately.
- ▶ Change out of any clothes contaminated with tire sealant immediately.
- ▶ If allergic reactions occur, seek medical attention immediately.

NOTE Overheating due to the tire inflation compressor running too long

- ▶ Do not run the tire inflation compressor for longer than ten minutes without interruption.

Comply with the manufacturer's safety notes on the sticker on the tire inflation compressor.

Have the tire sealant bottle replaced in a qualified specialist workshop every five years.

- ▶ Do not remove any foreign objects that have entered the tire.



- ▶ Affix part ① of the TIREFIT sticker to the instrument cluster within the driver's field of vision.
- ▶ Affix part ② of the TIREFIT sticker near the valve on the wheel with the defective tire.

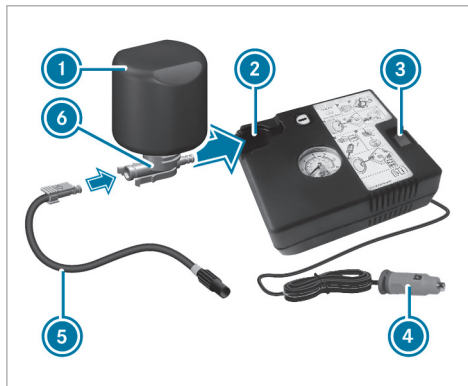

- ▶ Pull plug ④ with the cable and hose ⑤ out of the tire inflation compressor housing.

- ▶ Push the plug of hose ⑤ into flange ⑥ of tire sealant bottle ① until the plug engages.
- ▶ Place tire sealant bottle ① head downwards into recess ② of the tire inflation compressor.

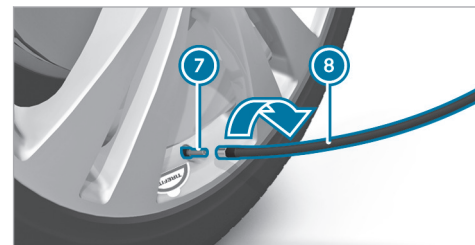

- ▶ Remove the valve cap from valve ⑦ on the faulty tire.
- ▶ Screw filling hose ⑥ onto valve ⑦.
- ▶ Insert plug ④ into a 12-V-socket in your vehicle.
- ▶ Switch on the vehicle.

- ▶ Switch on the tire inflation compressor using On/Off switch .
- The tire is inflated. First, tire sealant is pumped into the tire. The pressure may briefly rise to approximately 500 kPa (5.0 bar/73 psi).

Do not switch off the tire inflation compressor during this phase!

- ▶ Let the tire inflation compressor run for a maximum of ten minutes.
- The tire should then have attained a tire pressure of at least 200 kPa (2.0 bar/29 psi).

If tire sealant leaks out, make sure you clean the affected area as quickly as possible. It is preferable to use clean water.

If you get tire sealant on your clothing, have it cleaned as soon as possible with perchloroethylene.

If, after ten minutes, a tire pressure of 200 kPa (2.0 bar/29 psi) has not been attained:

- ▶ Switch off the tire inflation compressor.
- ▶ Unscrew the filling hose from the valve of the defective tire.

Please note that tire sealant may leak out when unscrewing the filling hose.

- ▶ Drive forwards or in reverse very slowly for approximately 33 ft (10 m).
 - ▶ Pump up the tire again.
- After a maximum of ten minutes the tire pressure must be at least 200 kPa (2.0 bar/29 psi).

⚠ WARNING Risk of accident due to the specified tire pressure not being achieved

If the specified tire pressure is not achieved after the specified time, the tire is too badly damaged. The tire sealant cannot repair the tire in this instance.

The braking characteristics as well as the driving characteristics may be greatly impaired.

- ▶ Do not continue driving.
- ▶ Consult a qualified specialist workshop.

If, after ten minutes, a tire pressure of 200 kPa (2.0 bar/29 psi) has been attained:

- ▶ Switch off the tire inflation compressor.

- ▶ Unscrew the filling hose from the valve of the defective tire.

⚠ WARNING Risk of accident from driving with sealed tires

A tire temporarily sealed with tire sealant impairs the handling characteristics and is not suitable for higher speeds.

- ▶ Adapt your driving style accordingly and drive carefully.
- ▶ Do not exceed the maximum speed limit with a tire that has been repaired using tire sealant.

- ▶ Observe the maximum permissible speed of 50 mph (80 km/h) for a tire sealed with tire sealant.

! NOTE Staining caused by leaking tire sealant

After use, excess tire sealant may leak out from the filling hose.

- ▶ Therefore, place the filling hose in the plastic bag that contained the TIREFIT kit.

 **ENVIRONMENTAL NOTE** Environmental pollution caused by environmentally irresponsible disposal

Tire sealant contains pollutants.

- ▶ Have the tire sealant bottle disposed of professionally, e.g. at an authorized Mercedes-Benz Center.

- ▶ Stow the tire sealant bottle and the tire inflation compressor.
- ▶ Pull away immediately.
- ▶ Stop driving after approximately ten minutes and check the tire pressure using the tire inflation compressor.
The tire pressure must now be at least 130 kPa (1.3 bar/19 psi).

 **WARNING** Risk of accident due to the specified tire pressure not being attained

If the specified tire pressure is not reached, the tire is too badly damaged. The tire sealant cannot repair the tire in this instance.

The braking and driving characteristics may be greatly impaired.

- ▶ Do not continue driving.
- ▶ Consult a qualified specialist workshop.

In cases such as the one mentioned above, contact an authorized Mercedes-Benz Center. Or call 1-800-FOR-MERCEdes (in the USA) or 1-800-387-0100 (in Canada).

- ▶ **To increase the tire pressure:** switch on the tire inflation compressor.

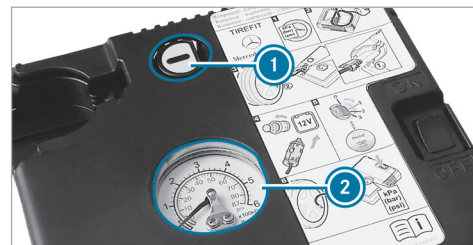

- ▶ **To reduce the tire pressure:** press pressure release button ① next to manometer ②.
- ▶ When the tire pressure is correct, unscrew the filling hose from the valve of the sealed tire.
- ▶ Screw the valve cap onto the valve of the sealed tire.
- ▶ Pull the tire sealant bottle out of the tire inflation compressor.
The filling hose stays on the tire sealant bottle.
- ▶ Drive to the nearest qualified specialist workshop and have the tire, tire sealant bottle and filling hose replaced there.

Battery (vehicle)**Notes on the 12 V battery**

⚠ WARNING Risk of an accident due to work carried out incorrectly on the battery

Work carried out incorrectly on the battery can, for example, lead to a short circuit. This can restrict functions relevant for safety systems and impair the operating safety of your vehicle.

You could lose control of the vehicle in the following situations in particular:

- When braking
 - In the event of abrupt steering maneuvers and/or when the vehicle's speed is not adapted to the road conditions
- ▶ In the event of a short circuit or a similar incident, contact a qualified specialist workshop immediately.
- ▶ Do not drive on.
- ▶ Always have work on the battery carried out at a qualified specialist workshop.

- Further information on ABS (→ page 230)
- Further information on ESP® (→ page 231)

For safety reasons, Mercedes-Benz recommends that you use only batteries that have been approved for your vehicle by Mercedes-Benz.

All vehicles except vehicles with a lithium-ion battery

⚠ WARNING Risk of explosion due to electrostatic charge

Electrostatic charge can ignite the highly explosive gas mixture in the battery.

- ▶ To discharge any electrostatic charge that may have built up, touch the metal vehicle body before handling the battery.

The highly flammable gas mixture is created while the battery is charging and during starting assistance.

⚠ WARNING Danger of chemical burns from the battery acid

Battery acid is caustic.

- ▶ Avoid contact with the skin, eyes or clothing.
- ▶ Do not lean over the battery.
- ▶ Do not inhale battery gases.
- ▶ Keep children away from the battery.
- ▶ Immediately rinse battery acid off thoroughly with plenty of clean water and seek medical attention immediately.

All vehicles

🔥 ENVIRONMENTAL NOTE Environmental damage due to improper disposal of batteries



Batteries contain pollutants. It is illegal to dispose of them with the household rubbish.



Dispose of batteries in an environmentally responsible manner.

Take discharged batteries to a qualified specialist workshop or to a collection point for used batteries.

If you have to disconnect the 12 V battery, contact a qualified specialist workshop.

Comply with safety notes and take protective measures when handling batteries.



Risk of explosion if the 12 V battery is used improperly.



Fire, naked flames and smoking are prohibited when you are handling the battery. Avoid creating sparks.



Electrolyte or battery acid is corrosive. Avoid contact with the skin, eyes or clothing. Wear suitable protective clothing, in particular gloves, an apron and a face mask. Immediately rinse electrolyte or acid splashes off with clean water. Consult a doctor immediately.



Do not place heavy objects on the surface of the battery or use the battery to support a person in any way.



Wear safety glasses.



Keep children away.



Observe this Operator's Manual.

Observe the following if you do not intend to use the vehicle over an extended period of time:

- **Non-plug-in hybrid:** switch to standby mode (→ page 228, 227).
- Alternatively: connect the battery to a battery charger approved by Mercedes-Benz or consult a qualified specialist workshop to disconnect the battery.

Notes on the 48 V battery



WARNING Risk of an accident due to work carried out incorrectly on the battery

Work carried out incorrectly on the battery can, for example, lead to a short circuit. This

can restrict functions relevant for safety systems and impair the operating safety of your vehicle.

You could lose control of the vehicle in the following situations in particular:

- When braking
- In the event of abrupt steering maneuvers and/or when the vehicle's speed is not adapted to the road conditions

▶ In the event of a short circuit or a similar incident, contact a qualified specialist workshop immediately.

▶ Do not drive on.

▶ Always have work on the battery carried out at a qualified specialist workshop.

- Further information on ABS (→ page 230)
- Further information on ESP® (→ page 231)

For safety reasons, Mercedes-Benz recommends that you use only batteries that have been approved for your vehicle by Mercedes-Benz.



ENVIRONMENTAL NOTE Environmental damage due to improper disposal of batteries



Batteries contain pollutants. It is illegal to dispose of them with the household trash.



Li-ion Dispose of batteries in an environmentally responsible manner. Take discharged batteries to a qualified specialist workshop or to a collection point for used batteries.

If you have to disconnect the 48 V battery, contact a qualified specialist workshop.

Comply with safety notes and take protective measures when handling batteries.



Risk of explosion if the 48 V battery is used improperly.



The surface of the 48 V battery may be hot.



Fire, naked flames and smoking are prohibited when you are handling the battery. Avoid creating sparks.



Electrolyte or battery acid is corrosive. Avoid contact with the skin, eyes or clothing. Wear suitable protective clothing, in particular gloves, an apron and a face mask. Immediately rinse off splashes of electrolyte or acid with plenty of clean water. Consult a doctor immediately.



Do not place heavy objects on the surface of the battery or use the battery to support a person in any way.



Do not perform any work on the battery. Always have any work on the battery carried out at a qualified specialist workshop. Do not disconnect the battery yourself. Do not attempt to open the battery.



Keep children away.



Wear safety glasses.



Observe this Operator's Manual.

Observe the following if you do not intend to use the vehicle over an extended period of time:

- **Non-plug-in hybrid:** switch to standby mode (→ page 228, 227).

Notes on the high-voltage battery



DANGER Risk of fire and explosion from excessive internal pressure of the high-voltage battery

In the event of a vehicle fire, flammable gas can escape and ignite.

- ▶ If there is an unusual smell, smoke or burn marks, stop the charging process immediately.
- ▶ Leave the danger zone immediately. Secure the danger area at a sufficient distance.
- ▶ Call the fire service.

Observe the notes on charging the high-voltage battery (→ page 204).



Risk of explosion.



Fire, open flames and smoking are prohibited when you are handling the battery. Avoid creating sparks.



Electrolyte or battery acid is corrosive. Avoid contact with the skin, eyes or clothing. Wear suitable protective clothing, especially gloves, an apron and a safety mask. Immediately rinse electrolyte or acid splashes off with clean water. Consult a doctor immediately.



Wear safety glasses.



Keep children away.



Observe this Operator's Manual.

Notes on starting assistance and charging the 12 V battery

All vehicles

When charging the battery and during starting assistance, always use the jump-start connection point in the engine compartment.

! **NOTE** Damage to the battery due to over-voltage

When charging using a battery charger without a maximum charging voltage, the battery or the on-board electronics may be damaged.

- ▶ Only use battery chargers with a maximum charging voltage of 14.8 V.

! **WARNING** Risk of explosion due to the ignition of hydrogen gas

If there is a short circuit or sparks are created, there is a danger of hydrogen gas igniting when you charge the battery.

- ▶ Make sure that the POSITIVE terminal of a connected battery does not come into contact with vehicle parts.
- ▶ Never place metal objects or tools on a battery.
- ▶ When connecting and disconnecting the battery, always observe the sequence of battery terminals described.
- ▶ During starting assistance, always take care to connect only battery terminals of identical polarity.
- ▶ During starting assistance, observe the sequence described for connecting and disconnecting the jumper cables.
- ▶ Do not connect or disconnect the battery terminals with the engine running.

! **WARNING** Risk of explosion due to a mixture of explosive gases

A mixture of explosive gases can escape from the battery during charging and jump starting.

- ▶ Fire, open flames, smoking and creating sparks must be avoided.
- ▶ Make sure that there is sufficient ventilation.
- ▶ Do not stand over the battery.

⚠ WARNING Risk of explosion from a frozen battery

A discharged battery may freeze at temperatures slightly above or below freezing point. During starting assistance or battery charging, battery gas can be released.

- ▶ Always allow a battery to thaw before charging it or performing starting assistance.

If the indicator/warning lamps on the instrument cluster do not light up at low temperatures, it is very likely that the discharged battery has frozen. In this case, you may neither jump-start the vehicle nor charge the battery.

The service life of a battery that has been thawed may be dramatically shortened. The starting char-

acteristics may be impaired, especially at low temperatures.

It is recommended that you have a thawed battery checked at a qualified specialist workshop.

Plug-in hybrid

If your vehicle has been started with starting assistance, it may not be possible to use the electric drive system for approximately 30 minutes.

Starting assistance is not considered to be a normal operating condition.

All vehicles

- !** **NOTE** Damage caused by numerous or extended attempts to start the engine

Numerous or extended attempts to start the engine may damage the catalytic converter due to non-combusted fuel.

- ▶ Avoid numerous and extended attempts to start the engine.

Observe the following points during starting assistance and when charging the battery:

- Use only undamaged jumper cables/charging cables with a sufficient cross-section and insulated terminal clamps.
- Non-insulated parts of the terminal clamps must not come into contact with other metal parts while the jumper cable/charging cable is connected to the battery/jump-start connection point.
- The jumper cable/charging cable must not come into contact with any parts that may move when the engine is running.
- Always make sure that neither you nor the battery is electrostatically charged.
- Keep away from fire and naked flames.
- Do not lean over the battery.

Observe the additional following points when charging the battery:

- Use only battery chargers tested and approved for Mercedes-Benz.
- Read the battery charger's operating instructions before charging the battery.

Observe the additional following points during starting assistance:

- Starting assistance may be provided only using vehicles, batteries or other jump start devices with a nominal voltage of 12 V.
- The vehicles must not touch.
- **Vehicles with gasoline engines:** jump-start the vehicle only when the engine and exhaust system are cold.

Starting assistance and charging the 12 V battery

Requirements

- The vehicle is secured with the electric parking brake.
- **Vehicles with automatic transmission:** the transmission is in position **P**.
- The vehicle and all electrical consumers are switched off.
- The hood is open.

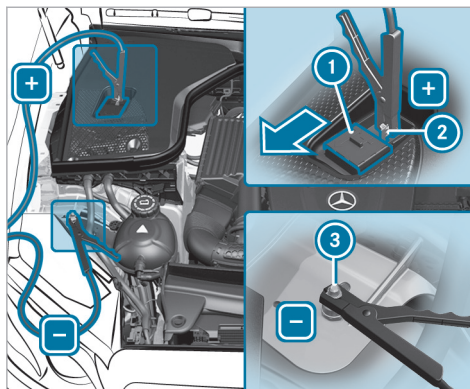

Example: engine compartment

- ▶ Slide cover **1** of POSITIVE contact **2** on the jump-starting connection point in the direction of the arrow.
- ▶ Connect POSITIVE contact **2** on your vehicle to the positive terminal of the donor battery using the jumper cable/charging cable.

Always begin with POSITIVE contact **2** on your own vehicle first.

- ▶ **During starting assistance:** start the engine of the donor vehicle and run it at idle speed.
- ▶ Connect the negative terminal of the donor battery and ground point **3** of your own vehicle using the jumper cable/charging cable. Begin with the donor battery first.
- ▶ **During starting assistance:** start the engine of your own vehicle.
- ▶ **During the charging process:** start the charging process.
- ▶ **During starting assistance:** let the engines run for several minutes.
- ▶ **During starting assistance:** before disconnecting the jumper cable, switch on an electrical consumer in your own vehicle, e.g. the rear window defroster or lighting.

When the starting assistance/charging process is complete, perform the following steps:

- ▶ First, remove the jumper cables/charging cables from ground point **3** and the negative

terminal of the donor battery, then POSITIVE contact ② and the positive terminal of the donor battery. Begin each time with the contacts on your own vehicle first.

- ▶ After removing the jumper cables/charging cables, close cover ① of POSITIVE contact ②.

Plug-in hybrid: if your vehicle has been started with starting assistance, it may not be possible to use the electric drive for approximately 30 minutes.

Further information can be obtained at a qualified specialist workshop.

Replacing the 12 V battery

- ▶ Observe the notes on the 12 V battery (→ page 397).

Mercedes-Benz recommends that you have the 12 V battery replaced at a qualified specialist workshop, e.g. at an authorized Mercedes-Benz Center.

Observe the following notes if you want to replace the battery yourself:

- Always replace a faulty battery with a battery that meets the specific vehicle requirements.

The vehicle is equipped with a battery using AGM (Absorbent Glass Mat) technology or a lithium-ion battery. Full vehicle functionality is guaranteed only with an AGM battery or lithium-ion battery. For safety reasons, Mercedes-Benz recommends that you use only batteries that have been tested and approved for your vehicle by Mercedes-Benz.

- Carry over detachable parts, such as vent hoses, elbow fitting or terminal covers from the battery being replaced.
- Make sure that the vent hose is always connected to the original opening on the side of the battery.

Install any existing or supplied cell caps.

Otherwise, gases or battery acid could escape.

- Make sure that detachable parts are reconnected in the same way.

Tow starting or towing away

Overview of the permitted towing methods (not plug-in hybrid)

! NOTE Damage from automatic braking

If one of the following functions is activated, the vehicle will brake automatically in certain situations:

- Active Brake Assist
- Active Distance Assist DISTRONIC
- HOLD function
- Active Parking Assist

To avoid damage to the vehicle, deactivate these systems in the following or similar situations:

- ▶ During towing.
- ▶ In a car wash.

Mercedes-Benz recommends transporting your vehicle in the case of a breakdown, rather than towing it away.

404 Breakdown assistance

For towing with both axles on the ground, use a tow rope or tow rod. Do not use tow bar systems.

! **NOTE** Damage to the vehicle due to towing away incorrectly

▶ Observe the instructions and notes on towing away.

Permitted towing methods

Vehicle equipment/towing method			
	Both axles on the ground	Front axle raised	Rear axle raised
4MATIC vehicles	Yes, for a maximum of 31 miles (50 km) at 31 mph (50 km/h)	No	No
Vehicles with rear wheel drive	Yes, for a maximum of 31 miles (50 km) at 31 mph (50 km/h)	No	Yes, if the steering wheel is fixed in the center position with a steering wheel lock

Towing with a raised axle: towing should be performed by a towing company.

Mercedes-Benz recommends transporting your vehicle in the case of a breakdown, rather than towing it away.

! **NOTE** Damage to the vehicle due to towing away incorrectly

▶ Observe the instructions and notes on towing away.

Permitted towing methods (plug-in hybrid)

Mercedes-Benz recommends transporting your vehicle in the case of a breakdown, rather than towing it away.

For towing with both axles on the ground, use a tow rope or tow rod. Do not use tow bar systems.

! **NOTE** Damage to the vehicle due to towing away incorrectly

- ▶ Observe the instructions and notes on towing away.

Observe the information on towing and transporting the vehicle in the vehicle Operator's Manual.

In the following situations, only transporting the vehicle is permitted:

- the driver's display is not working
- the  **Towing Not Permitted See Operator's Manual** display message appears in the driver's display

Permitted towing methods

Both axles on the ground	Front axle raised	Rear axle raised
Yes, for a maximum of 31 miles (50 km) at 31 mph (50 km/h)	No	No

Exception: if the vehicle is located in a danger zone, it can be recovered from the danger zone despite the display message or the display not working.

It must not be towed further than 164 ft (50 m) with both axles on the ground. A towing speed of 6 mph (10 km/h) must not be exceeded. Beyond these limits, only transporting is permitted.

Towing away the vehicle with both axles on the ground

- ▶ Observe the notes on the permitted towing methods (→ page 403).
- ▶ Plug-in hybrid: observe the notes on the permitted towing methods (→ page 405).
- ▶ Make sure that the battery is connected and charged.

A discharged battery has the following effects:

- the vehicle cannot be switched on
- the electric parking brake cannot be released or applied
- the transmission cannot be shifted to position **N** or **P**

i If the transmission cannot be shifted to position **N**, or the multifunction display in the instrument cluster does not show anything, the vehicle must be transported away (→ page 408). A towing vehicle with lifting equipment is required for vehicle transportation.

! **NOTE** Damage due to towing away at excessively high speeds or over long distances

The drivetrain could be damaged when towing at excessively high speeds or over long distances.

- ▶ A towing speed of 30 mph (50 km/h) must not be exceeded.
- ▶ A towing distance of 30 miles (50 km) must not be exceeded.

! **WARNING** Risk of accident when towing a vehicle which is too heavy

If the vehicle to be tow-started or towed away is heavier than the permissible gross mass of your vehicle, the following situations can occur:

- The towing eye may become detached.
 - The vehicle/trailer combination may swerve or rollover.
- ▶ Before tow-starting or towing away, check if the vehicle to be tow-started or

towed away exceeds the permissible gross mass.

- ▶ Information on the gross vehicle weight rating of the vehicle can be found on the vehicle identification plate (→ page 450).
- ▶ Do not open the driver's door or front passenger door as the transmission may otherwise shift to position **P** automatically.
- ▶ Install the towing eye (→ page 410).
- ▶ Fasten the towing device.

! **NOTE** Damage due to incorrect connection of the tow bar

- ▶ Only connect the tow rope or tow bar to the towing eyes.

- i** You can also attach the tow bar to the trailer hitch.
- ▶ Deactivate the automatic locking mechanism (→ page 82).
- ▶ Do not activate the HOLD function.
- ▶ Deactivate the tow-away alarm (→ page 100).

- ▶ Deactivate Active Brake Assist (→ page 257).
- ▶ Shift the transmission to position **N** (→ page 197).
- ▶ Release the electric parking brake.

! **WARNING** Risk of accident due to limited safety-related functions during the towing process

Safety-related functions are limited or no longer available in the following situations:

- The vehicle is switched off.
- The brake system or power steering system is malfunctioning.
- The energy supply or the on-board electrical system is malfunctioning.

When your vehicle is towed away, significantly more effort may be required to steer and brake than is normally required.

- ▶ Use a tow bar.
- ▶ Make sure that the steering wheel can move freely before towing the vehicle away.

! **NOTE** Damage due to excessive tractive power

If you pull away sharply, the tractive power may be too high and the vehicles could be damaged.

- ▶ Pull away slowly and smoothly.

Loading the vehicle for transport

Hybrid vehicles: Vehicles should be transported only by professional towing companies.

- ▶ Observe the notes on towing away (→ page 406).
- ▶ Connect the towing device to the towing eye in order to load the vehicle.
- i** You can also attach the tow bar to the trailer hitch.
- ▶ Shift the automatic transmission to position **N**.
- i** The automatic transmission may be locked in position **P** in the event of damage to the

electrics. To shift to **N**, supply the on-board electrical system with power (→ page 402).

- ▶ Load the vehicle onto the transporter.
- ▶ Shift the automatic transmission to position **P**.
- ▶ Use the electric parking brake to secure the vehicle against rolling away.
- ▶ Secure the vehicle only by the wheels.

Vehicles with ADS PLUS (Adaptive Damping System PLUS)

! **WARNING** Risk of an accident when transporting vehicles with Adaptive Damping System PLUS

When transporting vehicles with Adaptive Damping System PLUS, the vehicle/trailer combination may begin to rock and start to skid.

- ▶ Load the vehicle correctly onto the transporter.
- ▶ Secure the vehicle on all four wheels with suitable tensioning straps.

- ▶ Do not exceed the maximum permissible speed of 35 mph (60 km/h) when transporting.

! **NOTE** Damage to the vehicle from securing it incorrectly

- ▶ After loading, the vehicle must be secured on all four wheels. Otherwise, the vehicle could be damaged.
- ▶ A minimum distance of 8 in (20 cm) upwards and 4 in (10 cm) downwards must be kept to the transport platform.

- ▶ Secure the vehicle on all four wheels after loading.

4MATIC vehicles/vehicles with automatic transmission

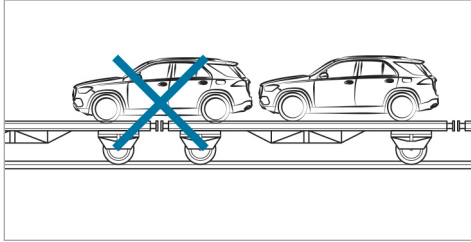

- ▶ Make sure that the front and rear axles come to rest on the same transportation vehicle.

! **NOTE** Damage to the drive train due to incorrect positioning of the vehicle

- ▶ Do not position the vehicle above the connection point of the transport vehicle.

Towing eye storage location

Plug-in hybrid

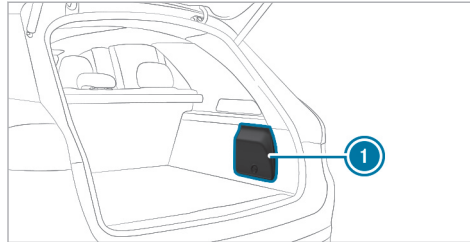

The towing eye is located in the cargo compartment on the right behind service flap ①.

Not plug-in hybrid

Vehicles with two rows of seats

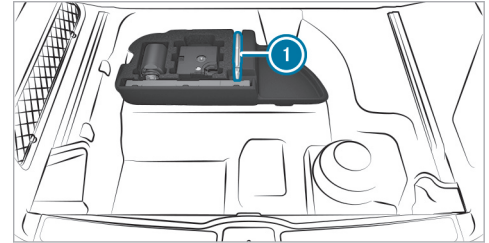

Towing eye ① is located under the cargo floor by the tire-change tool kit.

Vehicles with three rows of seats

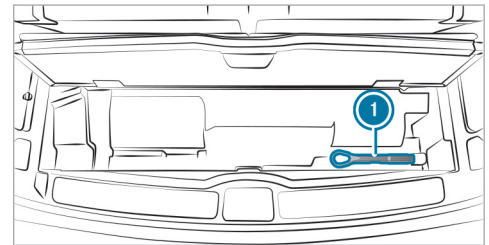

Towing eye ① is located under the cargo floor.

Installing and removing the towing eye

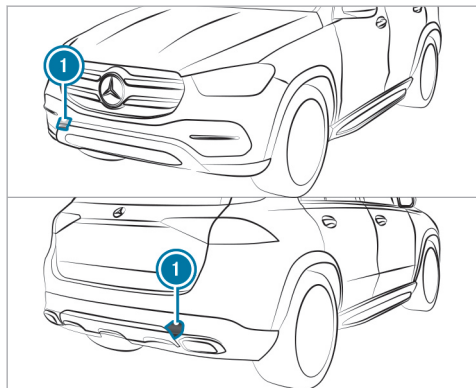

▶ Press the mark on cover ① inwards and remove.

▶ Screw in the towing eye clockwise at least seven revolutions as far as it will go and tighten it. If the towing eye cannot be screwed in as described above, this may be because the thread is dirty. The towing operation cannot be performed.

Vehicles with a trailer hitch: vehicles with a trailer hitch do not have a rear bracket for the towing eye. Fasten the tow bar to the trailer hitch.

▶ After removing the towing eye, snap cover ① into the bumper.

! **NOTE** Damage to the vehicle due to incorrect use of the towing eye or trailer hitch

When a towing eye or trailer hitch is used to recover a vehicle, the vehicle may be damaged in the process.

- ▶ Only use the towing eye or trailer hitch to tow away or tow start the vehicle.
- ▶ Do not use the towing eye or trailer hitch to tow the vehicle during recovery.

Tow-starting the vehicle

Vehicles with automatic transmission

! **NOTE** Damage to the automatic transmission due to tow starting

The automatic transmission may be damaged in the process of tow starting vehicles with automatic transmission.

▶ Vehicles with automatic transmission must not be tow started.

▶ Vehicles with automatic transmissions must not be tow-started.

Electrical fuses

Notes on electrical fuses

! **WARNING** Risk of accident and injury due to overloaded lines

If you manipulate or bridge a faulty fuse or if you replace it with a fuse with a higher amperage, the electric line could be overloaded.

This could result in a fire.

- ▶ Always replace faulty fuses with specified new fuses containing the correct amperage.

! NOTE Damage due to incorrect fuses

Using incorrect fuses can result in damage to electrical components or systems or their functions being considerably restricted.

- ▶ Use only fuses approved for Mercedes-Benz with the respective specified fuse rating.

Blown fuses must be replaced with fuses of the same rating, which you can recognize by the color and the label. The fuse ratings and further information to be observed can be found in the fuse assignment diagram.

Fuse assignment diagram: on the fuse box in the cargo compartment (→ page 412).

! NOTE Damage or malfunctions caused by moisture

Moisture may cause damage to the electrical system or cause it to malfunction.

- ▶ When the fuse box is open, make sure that no moisture can enter the fuse box.
- ▶ When closing the fuse box, make sure that the seal of the lid is positioned correctly on the fuse box.

If the newly inserted fuse also blows, have the cause traced and rectified at a qualified specialist workshop.

Ensure the following before replacing a fuse:

- The vehicle is secured against rolling away.
- All electrical consumers are switched off.
- The vehicle is switched off.

The electrical fuses are located in various fuse boxes:

- Fuse box in the engine compartment on the left-hand side of the vehicle, when viewed in the direction of travel (→ page 411)

- Fuse box on the driver's side of the cockpit (→ page 412)
- Fuse box in the front passenger footwell (→ page 412)
- Fuse box in the cargo compartment on the right-hand side of the vehicle, when viewed in the direction of travel (→ page 412)

Opening and closing the fuse box in the engine compartment

Requirement

- You need a dry cloth and a screwdriver.

Observe the notes on electrical fuses (→ page 410).

Opening

! WARNING Risk of injury from using the windshield wipers when the hood is open

If the windshield wipers start moving when the hood is open, you could be trapped by the wiper linkage.

- ▶ Always switch off the windshield wipers and vehicle before opening the hood.

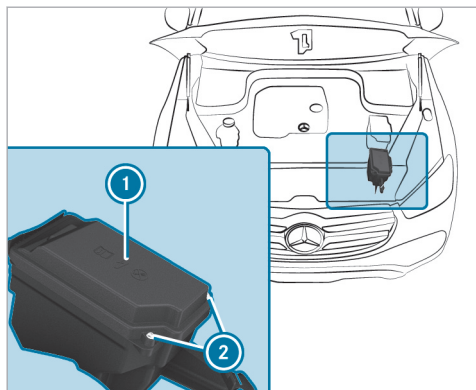

- ▶ Remove any existing moisture from the fuse box using a dry cloth.
- ▶ Loosen screws ② and remove fuse box lid ① from the top.

Closing

- ▶ Check whether the seal is positioned correctly in the lid.
- ▶ Insert the lid into the holder at the rear of the fuse box.
- ▶ Fold down the lid of the fuse box and tighten screws ②.
- ▶ Close the hood.

Opening and closing the fuse box in the cockpit

- Observe the notes on electrical fuses (→ page 410).

The fuse box is on the driver's side on the side of the cockpit under a cover.

- ▶ Mercedes-Benz recommends you have the fuse box opened at an authorized Mercedes-Benz Center.

Opening and closing the fuse box in the front passenger footwell

- ▶ Contact a Mercedes-Benz service center for further information.

Opening and closing the fuse box in the cargo compartment

Observe the notes on electrical fuses (→ page 410).

- ▶ Open the side cover.

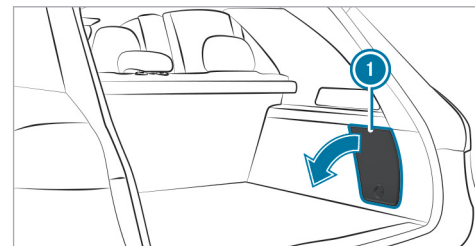

- ▶ Remove cover ①.

The fuse assignment diagram is on the side of the fuse box.

Notes on noise or unusual handling characteristics

Make sure there are no vibrations, noises or unusual handling characteristics when the vehicle is in motion. This may indicate that the wheels or tires are damaged. Hidden tire damage could also be causing the unusual handling characteristics.

If you suspect that a tire is defective, reduce your speed immediately and have the tires and wheels checked at a qualified specialist workshop.

Notes on regularly inspecting wheels and tires

⚠ WARNING Risk of injury through damaged tires

Damaged tires can cause tire pressure loss.

- ▶ Check the tires regularly for signs of damage and replace any damaged tires immediately.

⚠ WARNING Risk of hydroplaning due to insufficient tire tread

Insufficient tire tread will result in reduced tire grip.

In heavy rain or slush the risk of hydroplaning is increased, in particular where speed is not adapted to suit the conditions.

- ▶ Thus, you should regularly check the tread depth and the condition of the tread across the entire width of all tires.

Minimum tread depth for:

- Summer tires: $\frac{1}{8}$ in (3 mm)
- M+S tires: $\frac{1}{6}$ in (4 mm)

- ▶ For safety reasons, replace the tires before the legally-prescribed limit for the minimum tread depth is reached.

Carry out the following checks on all wheels regularly, at least once a month or as required, for example, prior to a long journey or driving off-road:

- Check the tire pressure (→ page 415).

- Visually inspect wheels and tires for damage.
- Check the valve caps.
- Visually inspect the tire tread depth and the tire contact surface across the entire width.

The minimum tread depth for summer tires is $\frac{1}{8}$ in (3 mm) and for winter tires $\frac{1}{6}$ in (4 mm).

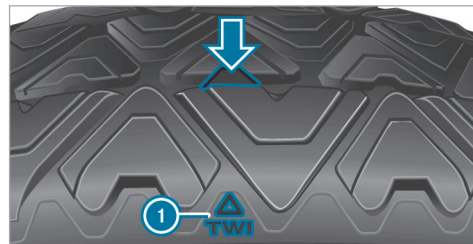

Six marks ① show where the bar indicators (arrow) are integrated into the tire tread. They are visible once a tire tread depth of approximately $\frac{1}{16}$ in (1.6 mm) has been reached.

Notes on snow chains

⚠ WARNING Risk of accident due to incorrectly installed snow chains

If you have installed snow chains on the front wheels, they may drag against the vehicle body or chassis components.

- ▶ Never install snow chains on the front wheels.
- ▶ Only install snow chains on the rear wheels in pairs.

! NOTE Damage to components of the vehicle body or chassis due to mounted snow chains

If you mount snow chains to the front wheels of 4MATIC vehicles, you may damage components of the vehicle body or chassis.

- ▶ Only mount snow chains to the rear wheels of 4MATIC vehicles.

- Snow chains are only permissible for certain wheel/tire combinations. You can obtain infor-

mation about this from an authorized Mercedes-Benz Center.

- For safety reasons, only use snow chains that have been specifically approved for your vehicle by Mercedes-Benz, or snow chains with the same quality standard.
 - Comply with the installation instructions of the snow chain manufacturer.
 - If snow chains are installed, the maximum permissible speed is 30 mph (50 km/h).
 - **Vehicles with Active Parking Assist:** do not use Active Parking Assist when snow chains are installed.
- i** You can deactivate ESP® to pull away (→ page 233). This allows the wheels to spin, achieving an increased driving force.

Tire pressure

Notes on tire pressure

⚠ WARNING Risk of accident due to insufficient or excessive tire pressure

Underinflated or overinflated tires pose in particular the following risks:

- The tires can burst.
- The tires can wear excessively and/or unevenly.
- The driving characteristics as well as the steering and braking characteristics may be greatly impaired.

▶ Comply with the recommended tire pressures and check the tire pressure of all tires, including the spare wheel, regularly:

- Monthly
- When the load changes
- Before embarking on a longer journey

- If operating conditions change, e.g. off-road driving
- ▶ Adjust the tire pressure, if necessary.

Tire pressure which is too high or too low can:

- Shorten the service life of the tires.
- Cause increased tire damage.
- Adversely affect driving characteristics and thus driving safety, e.g. due to hydroplaning.

⚠ WARNING Risk of accident due to too low a tire pressure

Tires with pressure that is too low can overheat and burst as a consequence.

In addition, they also suffer from irregular wear, which can significantly impair the braking properties and the handling characteristics.

- ▶ Avoid excessively low tire pressure.

Tire pressure which is too low can cause:

- Tire defects as a result of overheating

- Impaired handling characteristics
- Irregular wear
- Increased fuel consumption

⚠ WARNING Risk of accident due to too high a tire pressure

Tires with excessively high pressure can burst. In addition, they also suffer from irregular wear, which can significantly impair the braking properties and the handling characteristics.

- ▶ Avoid excessively high tire pressures.

Tire pressure which is too high can cause:

- Increased braking distance
- Impaired handling characteristics
- Irregular wear
- Impaired driving comfort
- Susceptibility to damage

⚠ WARNING Risk of accident due to repeated pressure drop in the tires

The wheels, valves or tires could be damaged. Too low a tire pressure can lead to the tires bursting.

- ▶ Examine the tires for foreign objects.
- ▶ Check whether the tire has a puncture or the valve has a leak.
- ▶ If you are unable to rectify the damage, contact a qualified specialist workshop.

You can find information on the recommended tire pressures for the vehicle's factory-installed tires on the following labels:

- Tire and Loading Information placard on the B-pillar of your vehicle (→ page 422).
- Tire pressure table on the inside of the fuel filler flap (→ page 417).

Observe the maximum tire pressure (→ page 428).

Use a suitable pressure gauge to check the tire pressure. The outer appearance of a tire does not

permit any reliable conclusion about the tire pressure.

Only correct tire pressure when the tires are cold. Conditions for cold tires:

- The vehicle has been parked with the tires out of direct sunlight for at least three hours.
- The vehicle has traveled less than 1 mile (1.6 km).

The vehicle's tires heat up when driving. As the temperature of the tires increases, so too does the tire pressure.

Vehicles with a tire pressure monitoring system: you can also see the tire pressure in the driver's display (→ page 419).

The tire pressure recommended for increased load/speed in the tire pressure table can affect the ride comfort.

⚠ WARNING Risk of accident due to unsuitable accessories on tire valves

If you mount unsuitable accessories onto tire valves, the tire valves may be overloaded and

malfunction, which can cause tire pressure loss.

- ▶ Only screw standard valve caps or valve caps specifically approved by Mercedes-Benz for your vehicle onto the tire valve.

Notes on trailer operation

Always inflate the rear axle tires to the recommended tire pressure on the tire pressure table for increased load.

Tire pressure table

The tire pressure table is on the inside of the fuel filler flap.

- ⓘ The data shown in the images is example data.

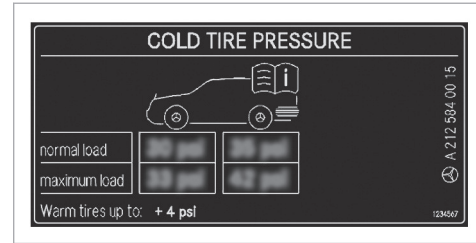

The tire pressure table shows the recommended tire pressure for all tires approved for this vehicle. The recommended tire pressures apply for cold tires under various operating conditions, i.e. loading and/or speed of the vehicle.

If one or more tire sizes precede a tire pressure, the following tire pressure information is only valid for those tire sizes and their respective load condition.

The load conditions "partially laden" and "fully laden" are defined in the table for different numbers of passengers and amounts of luggage. The actual number of seats may differ from this.

		kPa	psi	kPa	psi
R18	[Tread icons]				
R19	[Tread icons]				
M+S	[Tread icons]				

Some tire pressure tables only show the rim diameter instead of the complete tire size, e.g. **R18**. The rim diameter is part of the tire size and can be found on the tire side wall (→ page 429).

- Tire and Loading Information placard (→ page 422)
- Maximum tire pressures (→ page 428)

Checking the tire pressure manually

- ▶ Read the tire pressure recommended for the current operating conditions from the tire and loading information placard or the tire pressure table. Observe the notes on tire pressure.
- ▶ Remove the valve cap of the tire to be checked.
- ▶ Press the tire pressure gauge securely onto the valve.
- ▶ Read the tire pressure.
- ▶ If the tire pressure is lower than the recommended value, increase the tire pressure to the recommended value.
- ▶ If the tire pressure is higher than the recommended value, release air. To do so, press down the metal pin in the valve, e.g. using the tip of a pen. Then check the tire pressure again using the tire pressure gauge.
- ▶ Screw the valve cap onto the valve.

Further related subjects:

- Notes on tire pressure (→ page 415)
- Tire pressure table (→ page 417)

- Tire and loading information placard (→ page 422)

Tire pressure monitoring system

Function of the tire pressure monitoring system

⚠ DANGER Risk of accident due to incorrect tire pressure

Each tire, including the spare (if provided), should be checked monthly when cold and inflated to the inflation pressure recommended by the vehicle manufacturer on the vehicle placard or tire inflation pressure label. (If your vehicle has tires of a different size than the size indicated on the vehicle placard or tire inflation pressure label, you should determine the proper tire inflation pressure for those tires.)

As an added safety feature, your vehicle has been equipped with a tire pressure monitoring system (TPMS) that illuminates a low tire pressure telltale when one or more of your tires is significantly under-inflated. Accordingly, when

the low tire pressure telltale illuminates, you should stop and check your tires as soon as possible, and inflate them to the proper pressure. Driving on a significantly under-inflated tire causes the tire to overheat and can lead to tire failure. Under-inflation also reduces fuel efficiency and tire tread life, and may affect the vehicle's handling and stopping ability. Please note that the TPMS is not a substitute for proper tire maintenance, and it is the driver's responsibility to maintain correct tire pressure, even if under-inflation has not reached the level to trigger illumination of the TPMS low tire pressure telltale.

Your vehicle has also been equipped with a TPMS malfunction indicator to indicate when the system is not operating properly. The TPMS malfunction indicator is combined with the low tire pressure telltale. When the system detects a malfunction, the telltale will flash for approximately one minute and then remain continuously illuminated. This sequence will continue upon subsequent vehicle start-ups as long as the malfunction exists.

When the malfunction indicator is illuminated, the system may not be able to detect or signal low tire pressure as intended. TPMS malfunctions may occur for a variety of reasons, including the installation of replacement or alternate tires or wheels on the vehicle that prevent the TPMS from functioning properly.

The system checks the tire pressure and the tire temperature of the tires fitted to the vehicle by means of a tire pressure sensor.

The tire pressure and the tire temperature appear on the driver's display.

If there is a substantial pressure loss or if the tire temperature is excessive, you will be warned with display messages (→ page 528) or the  warning lamp on the driver's display (→ page 552).

The tire pressure monitoring system is only an aid. It is the driver's responsibility to set the tire pressure to the recommended cold tire pressure suitable for the operating situation.

In most cases, the tire pressure monitoring system will automatically update the new reference values after you have changed the tire pressure. You can, however, also update the reference values by restarting the tire pressure monitoring system manually (→ page 420).

System limits

The system may be impaired or may not function particularly in the following situations:

- incorrect reference values were taught in
- sudden pressure loss caused by a foreign object penetrating the tire, for example
- there is a malfunction caused by another radio signal source

■ Checking the tire pressure with the tire pressure monitoring system

Requirements

- The vehicle is switched on.

Driver's display:

  **▶▶ Service**

 Press  to confirm.

One of the following displays appears:

- Current tire pressure of each wheel:



- **Tire pressure displayed after driving for a few minutes.:** current values are not yet known to the system. The pressure/temperature values of each tire will be displayed as soon as they are known to the system.
 - **Tire Pressure Monitor Active:** the teach-in process of the system is not yet complete. The tire pressures are already being monitored.
- ▶ Compare the current tire pressure with the recommended tire pressure for the current

operating mode (→ page 417). Additionally, observe the notes on cold tires (→ page 415).

- ⓘ The values displayed on the driver's display may deviate from those of the tire pressure gauge as they refer to sea level. At high elevations, the tire pressure values indicated by a tire pressure gauge will be higher than those shown on the driver's display.

Bear in mind the following related topic:

- Notes on tire pressure (→ page 415)

Restarting the tire pressure monitoring system

Requirements

- The recommended tire pressure is correctly set for the respective operating status on each of the four wheels (→ page 415).

Restart the tire pressure monitoring system in the following situations:

- The tire pressure has changed.
- The wheels or tires have been changed or newly installed.

Driver's display:



- ▶ Select **Tire Pressure** and confirm with **OK**.
- ▶ Swipe downwards on Touch Control on the steering wheel.
The **Use current pressures as new reference values?** message is shown in the driver's display.
- ▶ Select **Yes** and confirm the restart with **OK**.
The **Tire Pressure Monitor Restarted** message is shown in the driver's display.
Current warning messages are deleted and the yellow  warning lamp goes out.
After you have been driving for a few minutes, the system checks whether the current tire pressures are within the specified range. The current tire pressures are then accepted as reference values and monitored.
If the tire pressure levels are not within the specified range, the **Please Correct Tire Pressure** message appears.

Bear in mind the following related topic:

- Notes on tire pressure (→ page 415)

Tire pressure loss warning system

Function of the tire pressure loss warning system

The tire pressure loss warning system warns the driver by means of display messages when there is a severe tire pressure loss.

System limits

The system may be impaired or may not function particularly in the following situations:

- incorrect reference values were taught in
- sudden pressure loss caused by a foreign object penetrating the tire, for example
- an even pressure loss on more than one tire occurs

The system has a restricted or delayed function particularly in the following situations:

- poor ground conditions, e.g. snow or gravel
- driving with snow chains
- when adopting a very sporty driving style with high cornering speeds or sudden acceleration
- driving with a very heavy or large trailer

- driving with a high load

The tire pressure loss warning system is only an aid. It is the driver's responsibility to set the tire pressure to the recommended cold tire pressure suitable for the operating situation and to check it.

Be sure to also observe the following further related subjects:

- Notes on tire pressure (→ page 415)
- Display messages about the tires (→ page 528)

Restarting the tire pressure loss warning system

Requirements

- The recommended tire pressure is correctly set for the respective operating status on each of the four wheels (→ page 415).

Restart the tire pressure loss warning system in the following situations:

- The tire pressure has changed.
- The wheels or tires have been changed or newly fitted.

Driver's display:

→  » Service

- ▶ Select **Tire Pressure** and confirm with **OK**. The **Run Flat Indicator Active** message is shown in the driver's display.
- ▶ To initiate a restart, press **OK** on the steering wheel. The **Are the current pressure values OK?** message is shown in the driver's display.
- ▶ Select **Yes**.
- ▶ To confirm restart, press **OK** on the steering wheel. The **Run Flat Indicator Restarted** message is shown in the driver's display.

Be sure to also observe the following further related subjects:

- Notes on tire pressure (→ page 415)

Loading the vehicle

Notes on the Tire and Loading Information placard

⚠ WARNING Risk of accident from overloaded tires

Overloaded tires may overheat and burst as a consequence. Overloaded tires can also impair the steering and handling characteristics and lead to brake failure.

- ▶ Observe the load rating of the tires.
- ▶ The load rating must be at least half the permissible axle load of the vehicle.
- ▶ Never overload the tires by exceeding the maximum load.

The Tire and Loading Information placard is on the B-pillar on the driver's side of the vehicle.

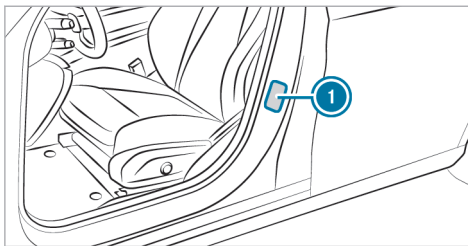

① Tire and Loading Information placard

TIRE AND LOADING INFORMATION		RENSEIGNEMENTS SUR LES PNEUS ET LE CHARGEMENT	
SEATING CAPACITY / NOMBRE DE PLACES		TOTAL	FRONT / AVANT
7		2	MI
REAR / ARRIERE		3	2
The combined weight of occupants and cargo should never exceed / Le poids total des occupants et du chargement ne doit jamais dépasser		XXX kg or	XXX lbs.*
TIRE / PNEU	SIZE / DIMENSIONS	COLD TIRE PRESSURE / PRESSION DES PNEUS À FROID	SEE OWNER'S MANUAL FOR ADDITIONAL INFORMATION / VOIR LE MANUEL DE L'USAGER POUR PLUS DE RENSEIGNEMENTS
FRONT / AVANT	255/40 ZR18 99Y XL	200 KPA, 29 PSI	
REAR / ARRIERE	285/35 ZR18 101Y XL	200 KPA, 29 PSI	
SPARE / DE SECOURS	175/55-18 95P	420 KPA, 60 PSI	

ⓘ The data shown in the illustration is example data.

The Tire and Loading Information placard shows the following information:

- Maximum number of seats ② according to the maximum number of people permitted to travel in the vehicle.

- Maximum permissible load ③ comprises the gross weight of all vehicle occupants, load and luggage.
- Recommended tire pressures ① for cold tires. The recommended tire pressures are valid for the maximum permissible load and up to the maximum permissible vehicle speed.

Please also note:

- Information on permissible weights and loads on the vehicle identification plate (→ page 450).
- Information on tire pressure in the tire pressure table (→ page 417).

Further related subjects:

- Determining the maximum permissible load (→ page 423)
- Notes on tire pressure (→ page 415).

Steps for Determining Correct Load Limit

The following steps have been developed as required of all manufacturers under Title 49, Code of U.S. Federal Regulations, Part 575, pursuant to

the "National Traffic and Motor Vehicle Safety Act of 1966".

- ▶ (1): Locate the statement "The combined weight of occupants and cargo should never exceed XXX kg or XXX lbs." on your vehicle's placard.
- ▶ (2): Determine the combined weight of the driver and passengers that will be riding in your vehicle.
- ▶ (3): Subtract the combined weight of the driver and passengers from XXX kg or XXX lbs.
- ▶ (4): The resulting figure equals the available amount of cargo and luggage load capacity. For example, if the "XXX" amount equals 1,400 lbs. and there will be five 150 lb passengers in your vehicle, the amount of available cargo and luggage load capacity is 650 lbs. (1,400 - 750 (5 x 150) = 650 lbs.)
- ▶ (5): Determine the combined weight of luggage and cargo being loaded on the vehicle. That weight may not safely exceed the available cargo and luggage load capacity calculated in Step 4.

- ▶ (6): If your vehicle will be towing a trailer, load from your trailer will be transferred to your vehicle. Consult this manual to determine how this reduces the available cargo and luggage load capacity of your vehicle.

- ① Not all vehicles are permitted to tow a trailer. Towing a trailer is only permitted if a trailer-hitch is installed. Please consult an authorized Mercedes-Benz dealer if you have any questions about towing a trailer with your vehicle.

Even if you have calculated the total load carefully, you should still make sure that the maximum permissible gross weight and the maximum gross axle weight rating of your vehicle are not exceeded. Details can be found on the vehicle identification plate.

- ▶ Have your loaded vehicle – including driver, occupants and load – weighed on a vehicle weighbridge. The measured values may not exceed the maximum permissible values stated on the vehicle identification plate.

424 Wheels and tires

Further related subjects:

- Calculation example for determining the maximum load (→ page 424)
- Tire and Loading Information placard (→ page 422)
- Tire pressure table (→ page 417)
- Vehicle identification plate (→ page 450)

Calculation example for determining the maximum load

The following table shows examples of how to calculate total and load capacities with varying seating configurations and different numbers and sizes of occupants. The following examples use a maximum load of 1500 lbs (680 kg). **This is for**

illustration purposes only. Make sure you are using the actual load limit for your vehicle stated on your vehicle's Tire and Loading Information placard (→ page 422).

The higher the weight of all the occupants, the smaller the maximum load for luggage.

Step 1

	Example 1	Example 2
Combined maximum weight of occupants and load (data from the Tire and Loading Information placard)	1500 lbs (680 kg)	1500 lbs (680 kg)

Step 2

	Example 1	Example 2
Number of people in the vehicle (driver and occupants)	5	1
Distribution of the occupants	Front: 2 Rear: 3	Front: 1
Weight of occupants	Occupant 1: 150 lbs (68 kg) Occupant 2: 180 lbs (82 kg) Occupant 3: 160 lbs (73 kg) Occupant 4: 140 lbs (63 kg) Occupant 5: 120 lbs (54 kg)	Occupant 1: 200 lbs (91 kg)
Total weight of all occupants	750 lbs (340 kg)	200 lbs (91 kg)

Step 3

	Example 1	Example 2
Permissible load (maximum gross vehicle weight rating from the Tire and Loading Information placard minus the gross weight of all occupants)	1500 lbs (680 kg) - 750 lbs (340 kg) = 750 lbs (340 kg)	1500 lbs (680 kg) - 200 lbs (91 kg) = 1300 lbs (589 kg)

Tire labeling

Overview of tire labeling

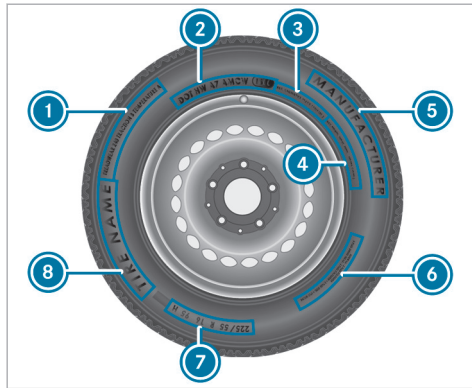

- ① Uniform Tire Quality Grading Standards
- ② DOT (Department of Transportation), (TIN) Tire Identification Number
- ③ Maximum tire load (→ page 428)
- ④ Maximum tire pressure (→ page 428)

- ⑤ Manufacturer
 - ⑥ Tire characteristics (→ page 429)
 - ⑦ Tire size designation, load-bearing capacity, speed rating and load index (→ page 429)
 - ⑧ Tire name
- ① The data shown in the illustration is example data.

Tire Quality Grading

In accordance with the US Department of Transportation's "Uniform tire Quality Grading Standards", tire manufacturers are required to grade their tires on the basis of the following three performance factors:

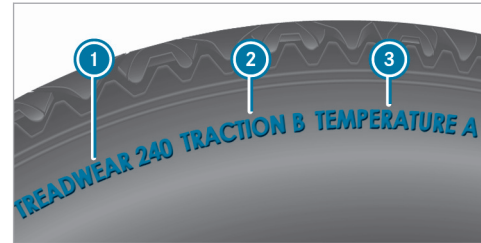

- ① Tread wear grade
 - ② Traction grade
 - ③ Temperature grade
- ① The data shown in the illustration is example data.
- ① The classification is not legally stipulated for Canada, but it is generally stated.

Tread wear grade

The treadwear grade is a comparative rating based on the wear rate of the tire when tested under controlled conditions on a specified government test course. For example, a tire graded 150 would wear one and one-half (1 1/2) times as

well on the government course as a tire graded 100.

The relative performance of tires depends upon the actual conditions of their use, however, and may depart significantly from the norm due to variations in driving habits, service practices and differences in road characteristics and climate.

Traction grade

⚠ DANGER Risk of accident due to inadequate traction

The traction grade assigned to this tire is based on straight-ahead braking traction tests.

- ▶ Always adapt your driving style and drive at a speed to suit the prevailing traffic and weather conditions.

! NOTE Damage to the drivetrain from wheelspin

- ▶ Avoid wheelspin.

The traction grades, from highest to lowest, are AA, A, B, and C. Those grades represent the tire's ability to stop on wet pavement as measured under controlled conditions on specified government test surfaces of asphalt and concrete. A tire marked C may have poor traction performance.

Temperature grade

⚠ WARNING Risk of accident from tire overheating and tire failure

Excessive speed, underinflation, or excessive loading, either separately or in combination, can cause excessive heat build-up and possible tire failure.

- ▶ Observe the recommended tire pressure.
- ▶ Regularly check the pressure of all the tires.
- ▶ Adjust the tire pressure, if necessary.

The temperature grades are A (the highest), B, and C, representing the tire's resistance to the generation of heat and its ability to dissipate heat when tested under controlled conditions on a specified indoor laboratory test wheel. Sustained

high temperature can cause the material of the tire to degenerate and reduce tire life, and excessive temperature can lead to sudden tire failure. The grade C corresponds to a level of performance which all passenger car tires must meet under the Federal Motor Safety Standard No. 109. Grades B and A represent higher levels of performance on the laboratory test wheel than the minimum required by law.

DOT, Tire Identification Number (TIN)

US tire regulations stipulate that every tire manufacturer or retreader must imprint a TIN in or on the side wall of each tire produced.

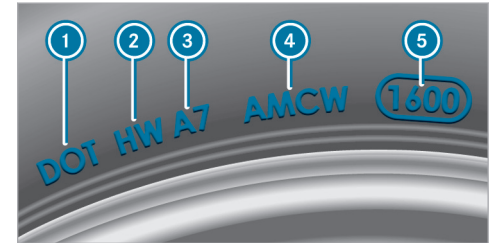

i The data shown in the illustration is example data.

The TIN is a unique identification number to identify tires and comprises the following:

- **DOT (Department of Transportation):** tire symbol marks **1** indicating that the tire complies with the requirements of the US Department of Transportation.
- **Manufacturer identification code:** manufacturer identification code **2** contains details of the tire manufacturer. New tires have a code with two symbols. Retreaded tires have a code with four symbols. Further information on retreaded tires (→ page 433).
- **Tire size:** identifier **3** describes the tire size.
- **Tire type code:** tire type code **4** can be used by the manufacturer as a code to describe specific characteristics of the tire.
- **Manufacturing date:** manufacturing date **5** provides information about the age of a tire. The 1st and 2nd positions represent the calendar week and the 3rd and 4th positions state the year of manufacture (e.g. "3208" represents the 32nd week of 2008).

Information on the maximum tire load



i The data shown in the illustration is example data.

Maximum tire load **1** is the maximum permissible weight for which the tire is approved.

Do not overload the tires by exceeding the specified load limit. The maximum permissible load can be found on the vehicle's Tire and Loading Information placard on the B-pillar on the driver's side (→ page 422).

Specifications for maximum tire pressure

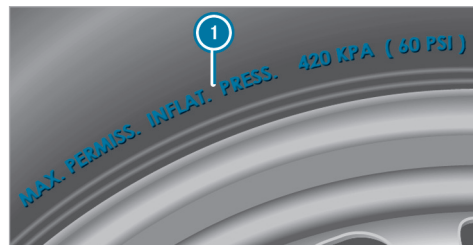

i The data shown in the illustration is example data.

Never exceed maximum tire pressure **1** specified for the tire. Always observe the recommended tire pressure for your vehicle when adjusting the tire pressure (→ page 417).

Information on tire characteristics



i The data shown in the illustration is example data.

This information describes the type of tire cord and the number of layers in side wall **1** and under tire tread **2**.

Tire size designation, load-bearing capacity, speed rating and load index

⚠ WARNING Risk of injury through exceeding the specified tire load-bearing capacity or the permissible speed rating

Exceeding the specified tire load rating or the permissible speed rating may lead to tire damage and to the tires bursting.

- ▶ Therefore, only use tire types and sizes approved for your vehicle model.
- ▶ Observe the tire load rating and speed rating required for your vehicle.

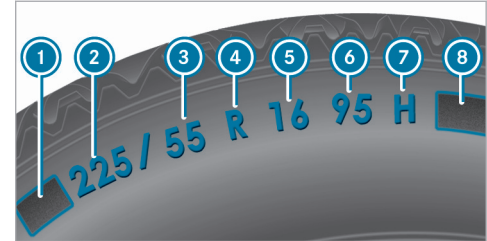

- 1** First letter(s)
- 2** Nominal tire width in millimeters
- 3** Aspect ratio in %
- 4** Tire code
- 5** Rim diameter
- 6** Load-bearing index
- 7** Speed rating
- 8** Load index

i The data shown in the illustration is example data.

Information about reading tire data can be obtained from any qualified specialist workshop.

First letter(s) 1:

- Without: passenger vehicle tires according to European manufacturing standards.
- "P": passenger vehicle tires according to US manufacturing standards.
- "LT": light truck tires according to US manufacturing standards.
- "T": compact emergency spare wheels with high tire pressure that are only designed for temporary use in an emergency.

Aspect ratio 3:

Ratio between tire height and tire width in percent (tire height divided by tire width).

Tire code 4 (tire type):

- "R" radial tire
- "D": bias ply tire
- "B": bias belted tires
- "ZR": radial tire with a maximum speed above 149 mph (240 km/h) (optional)

Rim diameter 5:

The diameter of the bead seat (not the diameter of the rim flange). The rim diameter is specified in inches (in).

Load-bearing index 6:

Numerical code that specifies the maximum load-bearing capacity of a tire (e.g. "91" corresponds to 1,356 lbs (615 kg)).

The load-bearing capacity of the tire must be at least half the gross axle weight rating of your vehicle. Do not overload the tires by exceeding the specified load limit.

See also:

- Maximum permissible load on the Tire and Loading Information placard (→ page 422)
- Maximum tire load (→ page 428)
- Load index

Speed rating 7:

Specifies the approved maximum speed of the tire.

- i** An electronic speed limiter prevents your vehicle from exceeding a speed of 130 mph (210 km/h).

Make sure that your tires have the required speed rating. You can obtain information on the required speed rating from an authorized Mercedes-Benz Center.

Summer tires

Index	Speed rating
Q	up to 100 mph (160 km/h)
R	up to 106 mph (170 km/h)
S	up to 112 mph (180 km/h)
T	up to 118 mph (190 km/h)
H	up to 130 mph (210 km/h)
V	up to 149 mph (240 km/h)
W	up to 168 mph (270 km/h)
Y	up to 186 mph (300 km/h)

Index	Speed rating
ZR...Y ¹	up to 186 mph (300 km/h)
ZR...(..Y) ¹	over 186 mph (300 km/h)
ZR ¹	over 149 mph (240 km/h)

- Specifying the speed rating as the "ZR" index in tire code ④ is optional for tires up to 186 mph (300 km/h).
- If your tire code ④ includes "ZR" and there is no speed rating ⑦, find out what the maximum speed is from the tire manufacturer.
- If load-bearing index ⑥ and speed rating ⑦ are in brackets, the maximum speed rating of your tire is above 186 mph (300 km/h). To find out the maximum speed, ask the tire manufacturer.

¹ "ZR" stated in the tire code.

² Or "M+S"  " for winter tires.

All-weather tires and winter tires

Index	Speed rating
Q M+S ²	up to 100 mph (160 km/h)
T M+S ²	up to 118 mph (190 km/h)
H M+S ²	up to 130 mph (210 km/h)
V M+S ²	up to 149 mph (240 km/h)

Winter tires bear the  snowflake symbol and fulfill the requirements of the Rubber Manufacturers Association (RMA) and the Rubber Association of Canada (RAC) regarding the tire traction on snow.

Load index ⑧:

- No specification given: standard load (SL) tire
- "XL" or "Extra Load": extra load tire or reinforced tire
- "Light Load": light load tire

- "C", "D", "E": a load range that depends on the maximum load that the tire can carry at a certain pressure

Definition of terms for tires and loading

Tire structure and characteristics: describes the number of layers or the number of rubber-coated belts in the tire contact surface and the tire wall. These are made of steel, nylon, polyester and other materials.

Bar: metric unit for tire pressure. 14.5038 pounds per square inch (psi) and 100 kilopascal (kPa) is the equivalent of one bar.

DOT (Department of Transportation): DOT-marked tires fulfill the requirements of the U.S. Department of Transportation.

Average weight of the vehicle occupants: the number of vehicle occupants for which the vehicle is designed, multiplied by 150 lb (68 kg).

Uniform Tire Quality Grading Standards: a uniform standard to grade the quality of tires with regard

to tread quality, tire traction and temperature characteristics. The quality grading assessment is made by the manufacturer following specifications from the U.S. government. The quality grade of a tire is printed on the side wall of the tire.

Recommended tire pressure: the recommended tire pressure is the tire pressure specified for the tires mounted on the vehicle at the factory.

The tire and information placard contains the recommended tire pressure for cold tires, the maximum permissible load and the maximum permissible vehicle speed.

The tire pressure table contains the recommended tire pressure for cold tires under various operating conditions, i.e. loading and/or speed of the vehicle.

Increased vehicle weight due to optional equipment: the combined weight of all standard and optional equipment available for the vehicle, regardless of whether it is actually installed on the vehicle or not.

Rim: the part of the wheel on which the tire is installed.

GAWR (Gross Axle Weight Rating): the GAWR is the maximum gross axle weight rating. The actual load on an axle must never exceed the gross axle weight rating. The gross axle weight rating can be found on the vehicle identification plate on the B-pillar on the driver's side.

Speed rating: the speed rating is part of the tire identification. It specifies the speed range for which a tire is approved.

GVW (Gross Vehicle Weight): the gross vehicle weight comprises the weight of the vehicle including fuel, tools, the spare wheel, any accessories installed, occupants, luggage and the trailer nose weight, if applicable. The gross vehicle weight must not exceed the gross vehicle weight rating GVWR as specified on the vehicle identification plate on the B-pillar on the driver's side.

GVWR (Gross Vehicle Weight Rating): the GVWR is the maximum permitted gross weight of the fully laden vehicle (weight of the vehicle including all accessories, occupants, fuel, luggage and the trailer drawbar nose weight if applicable). The gross vehicle weight rating is specified on the vehicle identification plate on the B-pillar on the driver's side.

Maximum weight of the laden vehicle: the maximum weight is the sum of the curb weight of the vehicle, the weight of the accessories, the maximum load and the weight of optional equipment installed at the factory.

Kilopascal (kPa): metric unit for tire pressure. 6.9 kPa corresponds to 1 psi. Another unit for tire pressure is bar. 100 kilopascal (kPa) equals 1 bar.

Load index: in addition to the load-bearing index, the load index may also be printed on the side wall of the tire. This specifies the load-bearing capacity of the tire more precisely.

Curb weight: the weight of a vehicle with standard equipment including the maximum capacity of fuel, oil and coolant. It also includes the air conditioning system and optional equipment if these are installed on the vehicle, but does not include passengers or luggage.

Maximum tire load: the maximum tire load is the maximum permissible weight in kilograms or lbs for which a tire is approved.

Maximum permissible tire pressure: maximum permissible tire pressure for one tire.

Maximum load on one tire: maximum load on one tire. This is calculated by dividing the maximum axle load of one axle by two.

PSI (pounds per square inch): standard unit of measurement for tire pressure.

Aspect ratio: ratio between tire height and tire width in percent.

Tire pressure: the pressure inside the tire which applies an outward force to every square inch of the tire. The tire pressure is specified in pounds per square inch (psi), in kilopascals (kPa) or in bar. The tire pressure should only be corrected when the tires are cold.

Cold tire pressure: the tires are cold when the vehicle has been parked for at least 3 hours without direct sunlight on the tires or the vehicle has been driven for less than 1 mile (1.6 km).

Tire contact surface: the part of the tire that comes into contact with the road.

Tire bead: the purpose of the tire bead is to ensure that the tire sits securely on the wheel rim. There are several wire cores in the tire bead to prevent the tire from changing length on the wheel rim.

Side wall: the part of the tire between the tread and the tire bead.

Weight of optional equipment: the combined weight of the optional equipment weighing more than the replaced standard parts and more than 5 lbs (2.3 kg). This optional equipment, such as high-performance brakes, level control system, a roof luggage rack or high-performance batteries, is not included in the curb weight and the weight of the accessories.

TIN (Tire Identification Number): a unique identification number which can be used by a tire manufacturer to identify tires, for example, in a product recall, and thus identify the purchasers. The TIN is made up of the manufacturer's identity code, tire size, tire type code and the manufacturing date.

Load-bearing index: the load-bearing index is a code that contains the maximum load-bearing capacity of a tire.

Traction: traction is the grip resulting from friction between the tires and the road surface.

Wear indicator: narrow bars (tread wear bars) that are distributed over the tire contact surface. If the

tire tread is level with the bars, the wear limit of 1/16 in (1.6 mm) has been reached.

Distribution of vehicle occupants: distribution of vehicle occupants over designated seat positions in a vehicle.

Maximum permissible payload weight: nominal load and luggage load plus 150 lb (68 kg) multiplied by the number of seats in the vehicle.

Changing a wheel

Notes on selecting, installing and replacing tires

! **NOTE** Mercedes-AMG vehicles

▶ Observe the notes in the Supplement. You could otherwise fail to recognize dangers.

⚠ **WARNING** Risk of accident due to incorrect wheel and tire dimensions

If wheels and tires of the wrong size are installed, the service brakes or components in the

brake system and in the wheel suspension may be damaged.

- ▶ Always replace wheels and tires with ones that fulfill the specifications of the original part.

For wheels, pay attention to the following:

- Designation
- Type

For tires, pay attention to the following:

- Designation
- Manufacturer
- Type

⚠ WARNING Risk of injury through exceeding the specified tire load-bearing capacity or the permissible speed rating

Exceeding the specified tire load rating or the permissible speed rating may lead to tire damage and to the tires bursting.

- ▶ Therefore, only use tire types and sizes approved for your vehicle model.
- ▶ Observe the tire load rating and speed rating required for your vehicle.

! NOTE Vehicle and tire damage caused by non-approved tire types and sizes

For safety reasons, only use tires, wheels and accessories which have been specially approved by Mercedes-Benz for your vehicle.

These tires are specially adapted to the active safety systems, such as ABS, ESP® and 4MATIC, and marked as follows:

- MO = Mercedes-Benz Original
- MOE = Mercedes-Benz Original Extended (run-flat tires only for certain wheels)
- MO1 = Mercedes-Benz Original (only certain AMG tires)

Otherwise, certain properties, such as handling characteristics, vehicle noise emissions, consumption, etc. could be adversely affected. Furthermore, other tire sizes could result

in the tires rubbing against the body and axle components when loaded. This could result in damage to the tire or the vehicle.

Only use tires, wheels and accessories that have been checked and recommended by Mercedes-Benz.

! NOTE Risk to driving safety from retreaded tires

Retreaded tires are neither tested nor recommended by Mercedes-Benz, since previous damage cannot always be detected on retreaded tires.

For this reason driving safety cannot be guaranteed.

- ▶ Do not use used tires if you have no information about their previous usage.

! NOTE Possible wheel and tire damage when driving over obstacles

Large wheels have a smaller section width. As the section width decreases, the risk of

wheels and tires being damaged when driving over obstacles increases.

- ▶ Avoid obstacles or drive especially carefully.
- ▶ Reduce your speed when driving over curbs, speed bumps, manhole covers and potholes.
- ▶ Avoid particularly high curbs.

! **NOTE** Possible wheel and tire damage when parking on curbs or in potholes

Parking on curbs or in potholes can damage the wheels and tires.

- ▶ Only park on as level a surface as possible.
- ▶ Avoid curbs and potholes when parking.

! **NOTE** Damage to electronic component parts due to the use of tire-installing tools

Vehicles with tire pressure monitoring system: There are electronic component parts in the wheel.

If tire-installing tools are positioned in the area of the valve, the electronic components could be damaged.

- ▶ Tire-installing tools should not be applied in the area of the valve.
- ▶ Always have tires change at a qualified specialist workshop.

! **NOTE** Damage to summer tires at low ambient temperatures

At low ambient temperatures, tears could form when driving with summer tires, causing permanent damage to the tires.

- ▶ At temperatures below 45 °F (7 °C) use  M+S tires.

Accessory parts which are not approved for your vehicle by Mercedes-Benz, or which are not used correctly, can impair the operating safety.

Before purchasing and using non-approved accessories, visit a qualified specialist workshop and enquire about:

- Suitability

- Legal stipulations
- Factory recommendations

! **WARNING** Risk of accident with high performance tires

The special tire tread in combination with the optimized tire compound means that the risk of skidding and hydroplaning on wet roads is increased.

In addition, the tire grip is greatly reduced at a low outside temperature and tire running temperature.

- ▶ Switch on the ESP[®] and adapt your driving style accordingly.
- ▶ Use  M+S tires at outside temperatures of less than 50 °F (10 °C).
- ▶ Only use the tires for their intended purpose.

Observe the following when selecting, installing and replacing tires:

- Furthermore, the use of certain tire types in certain regions and areas of operation can be highly beneficial.
- Only use tires and wheels of the same type (summer tires, winter tires, MOExtended tires) and the same make.
- Only install wheels of the same size on one axle (left and right).

It is only permissible to install a different wheel size in the event of a flat tire in order to drive to the specialist workshop.

- **Vehicles with a tire pressure monitoring system:** all installed wheels must be equipped with functioning sensors for the tire pressure monitoring system.
- At temperatures below 45°F (7°C) use winter tires or all-season tire marked  M+S for all wheels.

Winter tires provide the best possible grip in wintry road conditions.

- For M+S tires, only use tires with the same tread.
- Observe the maximum permissible speed for the M+S tires installed.
If the tire's maximum speed is below that of the vehicle, this must be indicated by an appropriate label in the driver's field of vision.
- Break in new tires at moderate speeds for the first 60 miles (100 km).
- Replace the tires after six years at the latest, regardless of wear.
- **When replacing with tires that do not feature run-flat characteristics:** vehicles with MOExtended tires are not equipped with a TIREFIT kit at the factory. Equip the vehicle with a TIREFIT kit after replacing with tires that do not feature run-flat characteristics, e.g. winter tires.

For more information on wheels and tires, contact a qualified specialist workshop.

Be sure to also observe the following further related subjects:

- Notes on tire pressure (→ page 415)

- Tire and Loading Information placard (→ page 422)
- Tire size designation, load-bearing capacity, speed rating and load index (→ page 429)
- Tire pressure table (→ page 417)
- Notes on the emergency spare wheel (→ page 443)

Notes on rotating wheels

 **WARNING** Risk of injury through different wheel sizes

Rotating the front and rear wheels can severely impair the driving characteristics. The wheel brakes or suspension components may also be damaged.

 Rotate front and rear wheels only if the wheels and tires are of the same dimensions.

Observe the instructions and safety notes on "Changing a wheel" (→ page 433)

The wear patterns on the front and rear wheels differ:

- Front wheels wear more on the tire shoulder
- Rear wheels wear more in the center of the tire

Do not drive with tires that have too little tread depth. This significantly reduces traction on wet roads (hydroplaning).

On vehicles that have the same size front and rear wheels, rotate the wheels according to the intervals in the tire manufacturer's warranty book in your vehicle documents. If this is not available, rotate the tires every 3,000 to 6,000 miles (5,000 to 10,000 km), depending on the wear. Ensure that the direction of rotation is maintained.

Notes on storing wheels

When storing wheels, observe the following notes:

- After removing wheels, store them in a cool, dry and preferably dark place.
- Protect the tires from contact with oil, grease or fuel.

Overview of the tire-change tool kit

Apart from some country-specific variants, vehicles are not equipped with a tire-change tool kit. For more information on which tools are required and approved to perform a wheel change on your vehicle, consult a qualified specialist workshop.

Required tire-changing tools may include, for example:

- Jack
- Chock
- Lug wrench

Tire-change tool kit ① is located under the cargo floor.

- ① Depending on the model, the tire change tool kit may be located in other positions under the cargo floor.

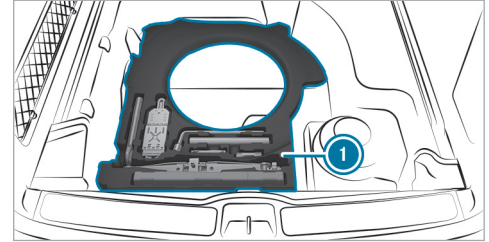

The tire-change tool kit includes the following:

- Jack
- Lug wrench
- Wheel studs
- Extension attachment for wheel studs, if necessary (depending on vehicle version)
- Folding chock
- Ratchet wrench

Plug-in hybrid

The tire-change tool kit is located in breakdown bag ①.

Depending on the vehicle version, the breakdown bag is located in the cargo compartment or under the cargo floor.

- ① When stowing the breakdown bag, make sure that it is adequately secured.

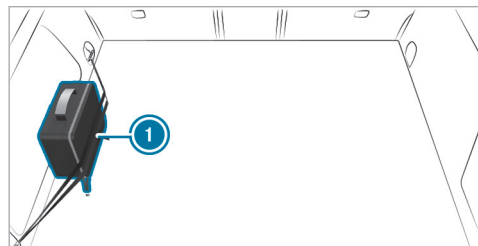

Preparing the vehicle for a wheel change

Requirements:

- The vehicle is not on a slope.
- The vehicle is on solid, non-slippery and level ground.
- The required tire-change tool kit is available.

- ① If your vehicle is not equipped with the tire-change tool kit, consult a qualified specialist workshop to find out about suitable tools.

- ▶ Apply the electric parking brake manually.
- ▶ Move the front wheels to the straight-ahead position.
- ▶ Shift the transmission to position **P**.
- ▶ **Vehicles with level control system:** Set the normal vehicle level (→ page 268).
- ▶ Switch off the vehicle.
- ▶ Make sure that the vehicle cannot be started.
- ▶ Place chocks or other suitable items under the front and rear of the wheel that is diagonally opposite the wheel you wish to change.
- ▶ Raise the vehicle (→ page 439).

Removing and installing the wheel trim/hub caps

Requirements

- The vehicle is prepared for a wheel change (→ page 438).

Plastic hub cap

To remove:

- ▶ Turn the center cover of the hub cap counter-clockwise and remove the hub cap.

To install:

- ▶ Make sure that the center cover of the hub cap is turned counter-clockwise.
- ▶ Position the hub cap and turn the center cover clockwise until the hub cap engages physically and audibly.

Aluminum hub cap

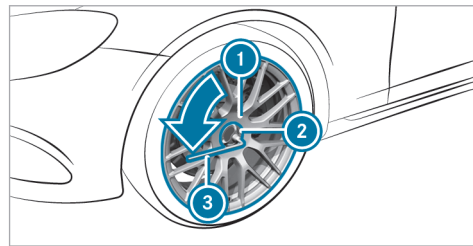

To remove:

- ▶ Position socket ② from the tire-change tool kit on hub cap ①.
- ▶ Position wheel wrench ③ on socket ②.
- ▶ Using wheel wrench ③, turn hub cap ① counter-clockwise and remove it.

To install:

- ▶ Follow the instructions above in reverse order.
- ⓘ **Specified tightening torque:** 18 lb-ft (25 Nm).

Raising the vehicle when changing a wheel

Requirements:

- There are no persons in the vehicle.
- The vehicle has been prepared for a wheel change (→ page 438).

Important notes on using the jack:

- Use only a vehicle-specific jack that has been approved by Mercedes-Benz to raise the vehicle.
- The jack is only designed for raising and holding the vehicle for a short time while a wheel

is being changed and not for maintenance work under the vehicle.

- The jack must be placed on a firm, flat and non-slip surface. If necessary, use a large, flat, load-bearing, non-slip underlay.
- The foot of the jack must be positioned vertically under the jack support point.

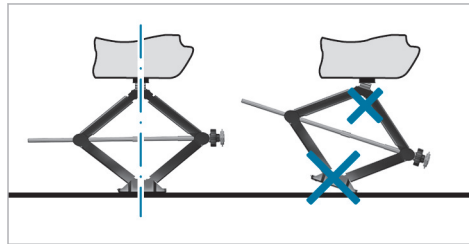

Rules of conduct when the vehicle is raised:

- Never place your hands or feet under the vehicle.
- Never lie under the vehicle.
- Do not start the vehicle and do not release the electric parking brake.

- Do not open or close any doors or the tailgate.

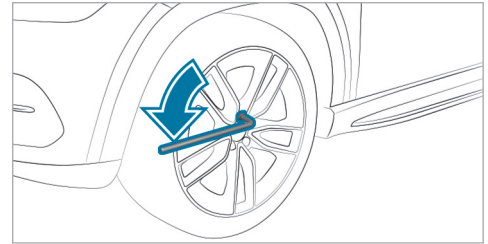

- ▶ Using the wheel wrench, loosen the wheel bolts on the wheel you wish to change by about one full turn. Do not unscrew the screws completely.

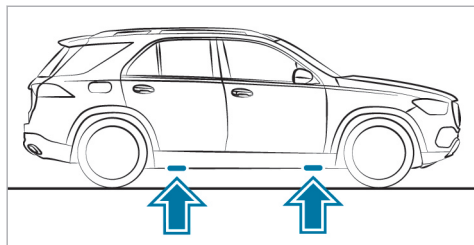

Position of the jack support points

⚠ WARNING Risk of injury from incorrect positioning of the jack

If you do not position the jack correctly at the appropriate jacking point of the vehicle, the jack could tip with the vehicle raised.

- ▶ Only position the jack at the appropriate jacking point of the vehicle. The base of the jack must be positioned vertically under the jacking point of the vehicle.

! NOTE Damage to the vehicle due to the jack

If you do not position the jack at the jack support points provided for this purpose, you could damage your vehicle.

- ▶ Only position the jack at the jack support points provided for this purpose.

- ▶ Take the ratchet wrench out of the tire-change tool kit and place it on the hexagon nut of the jack so that the letters "AUF" are visible.

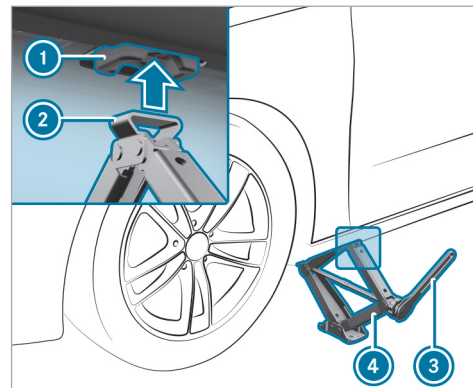

- ▶ Position support **2** of jack **4** on jack support point **1**.
- ▶ Turn ratchet wrench **3** clockwise until jack support **2** sits completely on jack support point **1** and the base of the jack lies evenly on the ground.

- ▶ Continue to turn ratchet wrench  until the tire is raised a maximum of 1.2 in (3 cm) off the ground.
- ▶ Loosen and remove the wheel (→ page 441).

Removing a wheel

Requirements

- The vehicle is raised (→ page 439).

NOTE Mercedes-AMG vehicles

- ▶ Observe the notes in the Supplement. You could otherwise fail to recognize dangers.

When changing a wheel, avoid applying any force to the brake discs, as this could impair the level of comfort when braking.

NOTE Damage to threading from dirt on wheel bolts

- ▶ Do not place wheel bolts in sand or on a dirty surface.

- ▶ Completely unscrew the wheel bolts.
- ▶ Remove the wheel.

Installing a new wheel

Requirements

- The wheel that is to be replaced is removed (→ page 441).

NOTE Mercedes-AMG vehicles

- ▶ Observe the notes in the Supplement. You could otherwise fail to recognize dangers.

WARNING Risk of accident from losing a wheel

Oiled, greased or damaged wheel bolt/wheel nut threads or wheel hub/wheel mounting bolt threads can cause the wheel bolts/wheel nuts to come loose.

- ▶ Never oil or grease the threads.

- ▶ In the event of damage to the threads, contact a qualified specialist workshop immediately.
- ▶ Have the damaged wheel bolts or damaged hub threads replaced.
- ▶ Do not continue driving.

- ▶ Observe the information on the choice of tires (→ page 433).

For tires with a specified direction of rotation, an arrow on the side wall of the tire indicates the correct direction of rotation. Observe the direction of rotation when installing.

- ▶ Place the wheel to be installed on the wheel hub and push it on.

WARNING Risk of injury from tightening wheel bolts and nuts

If you tighten the wheel bolts or wheel nuts when the vehicle is raised, the jack could tip.

- ▶ Only tighten wheel bolts or wheel nuts when the vehicle is on the ground.

- ▶ Observe the instructions and safety notes on "Changing a wheel" (→ page 433).
- ▶ For safety reasons, only use wheel bolts which have been approved by Mercedes-Benz and for the wheel in question.

! **NOTE** Damage to paintwork of the wheel rim when screwing in the first wheel bolt

If the wheel has too much play when screwing in the first wheel bolt, the wheel rim paint can be damaged.

- ▶ Press the wheel firmly against the wheel hub when screwing in the first wheel bolt.

- ▶ Tighten the wheel bolts evenly in a diagonal pattern in the order indicated until they are finger-tight.
- ▶ If the collapsible spare wheel has been installed, inflate the collapsible spare wheel (→ page 446).
- ▶ Lower the vehicle (→ page 442).

Lowering the vehicle after a wheel change

Requirements:

- The new wheel has been mounted (→ page 441).

Observe the information on tire pressure (→ page 415).

- ▶ Place the ratchet wrench onto the hexagon nut of the jack so that the lettering "AB" is visible.
- ▶ **To lower the vehicle:** turn the ratchet wrench of the jack counter-clockwise.

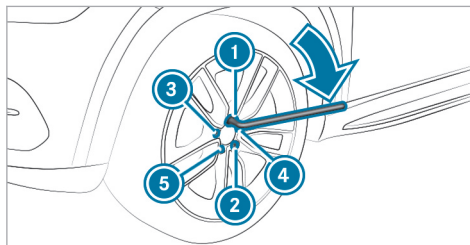

- ▶ Tighten the wheel bolts evenly in a diagonal pattern in the order indicated ① to ⑤ with a maximum of 59 lb-ft (80 Nm).
- ▶ Then tighten the wheel bolts evenly in a diagonal pattern in the order indicated ① to ⑤ to the specified tightening torque of 111 lb-ft (150 Nm).

! **WARNING** Risk of accident due to incorrect tightening torque

The wheels could come loose if the wheel bolts or wheel nuts are not tightened to the prescribed torque.

- ▶ Ensure that the wheel bolts or wheel nuts are tightened to the prescribed tightening torque.
- ▶ If you are not sure, do not move the vehicle. Contact a qualified specialist workshop and have the tightening torque checked immediately.

- ▶ Check the tire pressure of the newly mounted wheel and adjust accordingly.

- ⓘ The following does not apply if the new wheel is an emergency spare wheel.
- ▶ **Vehicles with a tire pressure loss warning system:** restart the tire pressure loss warning system (→ page 421).
 - ▶ **Vehicles with a tire pressure monitoring system:** restart the tire pressure monitoring system (→ page 420).

Emergency spare wheel

Notes on the emergency spare wheel

⚠ **WARNING** Risk of accident caused by incorrect wheel and tire dimensions

The wheel or tire sizes and the tire type of the emergency spare wheel or spare wheel and the wheel to be replaced may differ. The emergency spare wheel or spare wheel can significantly impair driving characteristics of the vehicle.

To prevent hazardous situations:

- ▶ Drive carefully.

- ▶ Never install more than one emergency spare wheel or spare wheel that differs in size.
- ▶ Only use an emergency spare wheel or spare wheel briefly.
- ▶ Do not deactivate ESP®.
- ▶ Have the emergency spare wheel or spare wheel of a different size replaced at the nearest qualified specialist workshop. The new wheel must have the correct dimensions.

- ⓘ The emergency spare wheel is fastened in the load compartment under the load compartment floor.

Observe the following notes on installing an emergency spare wheel:

- The maximum permissible speed with an emergency spare wheel installed is 50 mph (80 km/h).
- Do not install the emergency spare wheel with snow chains.

- Replace the emergency spare wheel after six years at the latest, regardless of wear.
 - Use the wheel bolts that are included with the emergency spare wheel.
 - Check the tire pressure of the emergency spare wheel installed. Correct the pressure as necessary.
- ⓘ The specified tire pressure is stated on the label of the emergency spare wheel.
- ⓘ **Vehicles with a tire pressure loss warning system:** if an emergency spare wheel is installed, the tire pressure loss warning system cannot function reliably. Only restart the system again when the emergency spare wheel has been replaced with a new wheel.
- Vehicles with a tire pressure monitoring system:** if an emergency spare wheel is installed, the tire pressure monitoring system cannot function reliably. For a few minutes after an emergency spare wheel is installed, the system may still display the tire pressure of the removed wheel. Only restart the system again when the emergency spare wheel has been replaced with a new wheel.

Be sure to also observe the following further related subjects:

- Notes on tire pressure (→ page 415)
- Tire and loading information placard (→ page 422)
- Tire pressure table (→ page 417)
- Notes on installing tires (→ page 433)
- Installing an emergency spare wheel (→ page 438)

Inflating the emergency spare wheel

! **NOTE** Overheating due to the tire inflation compressor running too long

- ▶ Do not run the tire inflation compressor for longer than ten minutes without interruption.

Requirements:

- The emergency spare wheel has been installed correctly. (→ page 438)

- ▶ **i** Comply with the manufacturer's safety notes on the sticker of the emergency spare wheel and on the tire inflation compressor.
- ▶ Remove the sticker with the label 50 mph (80 km/h) from the tire inflation compressor housing and affix it to the instrument cluster within the driver's field of vision.
- ▶ Remove the tire inflation compressor from the stowage space under the trunk floor. (→ page 392, 393)

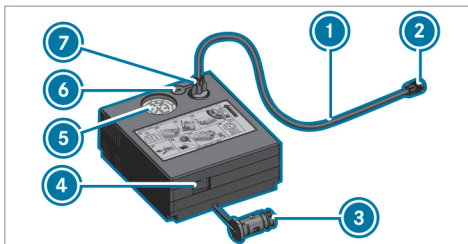

- ▶ Pull filler hose ① and plug ③ out of the tire inflation compressor housing.

- ▶ Insert plug ⑦ of filler hose ① in the socket on the tire inflation compressor and then turn it until plug ⑦ engages.
- ▶ Unscrew the cap from the valve on the emergency spare wheel.
- ▶ Screw union nut ② of filler hose ① onto the valve.
- ▶ Make sure on and off switch ④ of the tire inflation compressor is set to 0.
- ▶ Insert plug ③ in a socket in your vehicle.
 - Cigarette lighter socket
 - 12 V socket: (→ page 135)
- Observe the notes on the cigarette lighter in the Digital Operator's Manual
- Observe the notes on sockets: (→ page 135)
- ▶ Press the start/stop button once to switch on the power supply (→ page 171).

- ▶ Press On/Off switch ④ on the tire inflation compressor to I.
The tire inflation compressor is switched on. The tire is inflated. The tire pressure appears on manometer ⑤.
- ▶ Pump the tire to the specified tire pressure.
- ① The specified tire pressure is stated on the label of the emergency spare wheel.
- ▶ When the specified tire pressure has been reached, press on and off switch ④ on the tire inflation compressor to 0.
The tire inflation compressor is switched off.
- ▶ Press the start/stop button to switch off the power supply.
- ▶ If the tire pressure is higher than the specified pressure, press pressure release valve button ⑥ until the correct tire pressure has been reached.
- ▶ Unscrew union nut ② of filler hose ① from the valve.
- ▶ Screw the valve cap of the emergency spare wheel onto the valve again.

- ▶ Stow filler hose ① and plug ③ in the lower section of the tire inflation compressor housing.
- ▶ Stow the tire inflation compressor in the vehicle.

Collapsible spare wheel

Notes on the collapsible spare wheel

⚠ WARNING Risk of accident caused by incorrect wheel and tire dimensions

The wheel or tire sizes and the tire type of the emergency spare wheel or spare wheel and the wheel to be replaced may differ. The emergency spare wheel or spare wheel can significantly impair driving characteristics of the vehicle.

To prevent hazardous situations:

- ▶ Drive carefully.
- ▶ Never install more than one emergency spare wheel or spare wheel that differs in size.

- ▶ Only use an emergency spare wheel or spare wheel briefly.
- ▶ Do not deactivate ESP®.
- ▶ Have the emergency spare wheel or spare wheel of a different size replaced at the nearest qualified specialist workshop. The new wheel must have the correct dimensions.

The collapsible spare wheel is an emergency spare wheel which is only suitable for use for a limited period of time and in a restricted manner in the event of a flat tire (e.g. until the nearest workshop).

The tire sidewalls are folded when in transport mode. Before use, the collapsible spare wheel has to be inflated with the accompanying compressor.

Check the tire pressure of the collapsible spare wheel once installed. Correct the pressure as necessary.

The maximum permissible speed with a collapsible spare wheel installed is 50 mph (80 km/h).

Do not install the collapsible spare wheel with snow chains.

Replace the collapsible spare wheel after six years at the latest, regardless of wear.

i Vehicles with a tire pressure loss warning system: if a collapsible spare wheel is installed, the tire pressure loss warning system cannot function reliably. Only restart the system again when the collapsible spare wheel has been replaced with a new wheel.

Vehicles with a tire pressure monitoring system: if a collapsible spare wheel is installed the tire pressure monitoring system cannot function reliably. For a few minutes after an emergency spare wheel is installed, the system may still display the tire pressure of the removed wheel. Only restart the system again when the collapsible spare wheel has been replaced with a new wheel.

Be sure to also observe the following further related subjects:

- Notes on tire pressure (→ page 415)
- Tire pressure table (→ page 417)

Removing the collapsible spare wheel

The collapsible spare wheel is located under the cargo compartment floor.

- ▶ Observe the information on mounting tires (→ page 433).
- ▶ Open the tailgate.
- ▶ Open the cargo compartment floor.
- ▶ Remove the collapsible spare wheel.

Inflating the collapsible spare wheel

Requirements:

- Mount the collapsible spare wheel as described (→ page 441).
- Remove the tire inflation compressor from the storage space under the trunk floor (→ page 392, 393).

! **NOTE** Damage to the collapsible spare wheel when lowering the vehicle

Lowering the vehicle without previously inflating the collapsible spare wheel can damage its rim.

▶ Inflate the collapsible spare wheel using the tire inflation compressor before lowering the vehicle.

! **NOTE** Overheating due to the tire inflation compressor running too long

▶ Do not run the tire inflation compressor for longer than ten minutes without interruption.

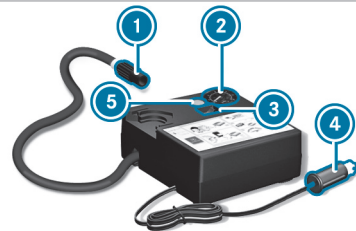

▶ Pull connector **4** and the hose out of the housing.

- ▶ Unscrew the cap from the valve on the collapsible spare wheel.
 - ▶ Screw union nut ❶ of the hose onto the valve.
 - ▶ Make sure on and off switch ❸ of the tire inflation compressor is set to 0.
 - ▶ Insert connector ❷ into the cigarette lighter socket or into a 12 V socket (→ page 135) in your vehicle.
 - ▶ Switch on the power supply (→ page 171).
 - ▶ Press on and off switch ❸ on the tire inflation compressor to I.
The tire inflation compressor is switched on. The tire is inflated. The tire pressure is shown on manometer ❹.
 - ▶ Pump the tire to the specified tire pressure.
- ❶ The specified tire pressure is printed on the yellow label of the collapsible spare wheel.
- ▶ When the specified tire pressure has been reached, press on and off switch ❸ on the tire inflation compressor to 0.
- ▶ If the tire pressure is higher than the specified pressure, press pressure release valve button ❺ until the correct tire pressure has been reached.

Notes on technical data

! NOTE Mercedes-AMG vehicles

- ▶ Observe the notes in the Supplement. You could otherwise fail to recognize dangers.

The data stated only applies to vehicles with standard equipment. You can obtain further information from an authorized Mercedes-Benz Center.

Vehicle electronics

Two-way radios

Notes on installing two-way radios

! WARNING Risk of accident due to improper work on two-way radios

If two-way radios are manipulated or retrofitted incorrectly, the electromagnetic radiation from the two-way radios can interfere with the vehicle electronics and jeopardize the operating safety of the vehicle.

- ▶ You should have all work on electrical and electronic components carried out at a qualified specialist workshop.

! WARNING Risk of accident due to improper operation of two-way radios

If you use two-way radios in the vehicle improperly, their electromagnetic radiation can disrupt the vehicle's electronics. This is the case in the following situations, in particular:

- The two-way radio is not connected to an exterior antenna.
- The exterior antenna is installed incorrectly or is not a low-reflection antenna.

This could jeopardize the operating safety of the vehicle.

- ▶ Have the low-reflection exterior antenna installed at a qualified specialist workshop.

- ▶ When operating two-way radios in the vehicle, always connect them to the low-reflection exterior antenna.

! NOTE Invalidation of the operating permit due to failure to comply with the instructions for installation and use

The operating permit may be invalidated if the instructions for installation and use of two-way radios are not observed.

- ▶ Only use approved frequency bands.
- ▶ Observe the maximum permissible output power in these frequency bands.
- ▶ Only use approved antenna positions.

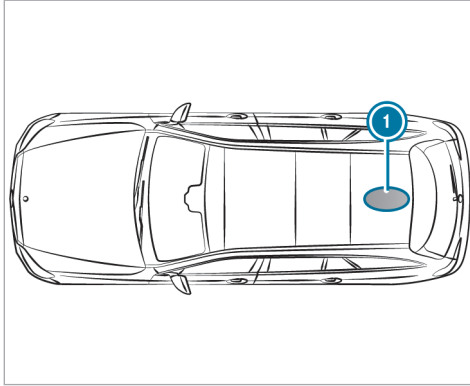

① Rear roof area

On vehicles with a panorama roof with power tilt/sliding panel, the installation of an antenna is not permitted.

Use Technical Specification ISO/TS 21609 (Road Vehicles - "EMC guidelines for installation of aftermarket radio frequency transmitting equipment") when retrofitting two-way radios. Comply with the legal requirements for detachable parts.

If your vehicle has a pre-installation for two-way radio equipment, use the power supply and antenna connectors provided in the pre-installation. Observe the manufacturer's supplements during installation.

■ Two-way radio transmission output

The maximum transmission output (PEAK) at the base of the antenna must not exceed the values in the following table.

Frequency band and maximum transmission output

Frequency band	Maximum transmission output
2-m- frequency band 144-174 MHz	50 W
Terrestrial Trunked Radio (TETRA) 380-460 MHz	10 W

Frequency band	Maximum transmission output
Two-way radio 2G	2 W
Two-way radio 3G/4G/5G	0.5 W

The following can be used in the vehicle without restrictions:

- two-way radios with a maximum transmission output of 100 mW
- RF transmitters with transmitter frequencies in the 380-410 MHz frequency band and a maximum transmission output of 2 W (TETRA)
- mobile phones (2G/3G/4G/5G)

There are no restrictions regarding the position of the antenna on the outside of the vehicle for the following frequency bands:

- Terrestrial Trunked Radio (TETRA)
- 2G/3G/4G/5G

Radio regulations

Regulatory radio identification and specific notes

Manufacturer information about radio-based vehicle components can be found using the key phrase "Regulatory radio information" in the Digital Operator's Manual in the vehicle, on the internet and in the app.

Further information and updates are available at the following web address:

<https://regulatoryradioinformation.corpinter.net/us>



Vehicle identification plate, VIN and engine number overview

Vehicle identification plate

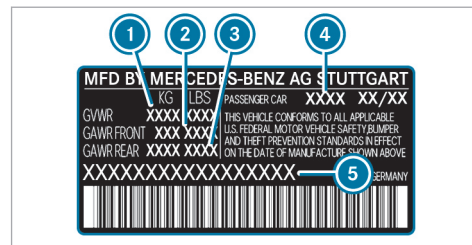
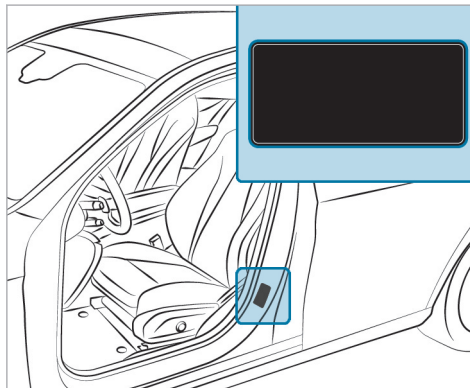

Vehicle identification plate (USA only)

- ① Maximum permissible gross vehicle weight
- ② Maximum permissible front axle load
- ③ Maximum permissible rear axle load
- ④ Paint code
- ⑤ VIN (vehicle identification number)

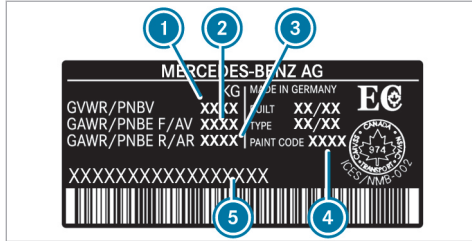

Vehicle identification plate (Canada only)

- ① Maximum permissible gross vehicle weight
- ② Maximum permissible front axle load
- ③ Maximum permissible rear axle load
- ④ Paint code
- ⑤ VIN (vehicle identification number)

The maximum permissible gross vehicle weight is made up of the vehicle weight, all vehicle occupants, the fuel and the load. The maximum gross axle weight rating is the maximum weight that can be carried on one axle (front or rear axle).

Never exceed the maximum permissible gross vehicle weight or the maximum gross axle weight rating for the front or rear axle.

VIN in front of the front seat

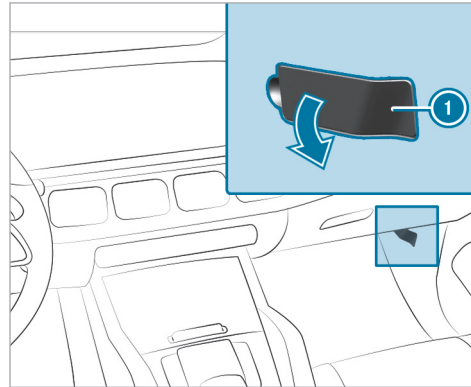

- ① VIN (vehicle identification number)

Additional plates

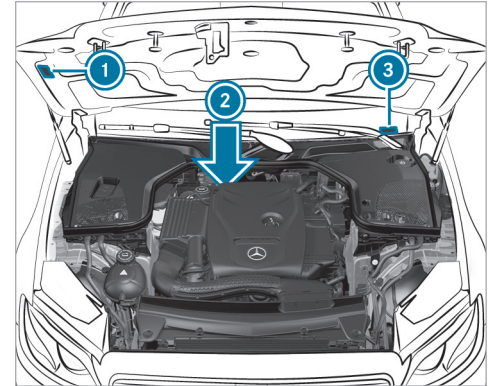

- ① Plate with information about emissions testing, including confirmation of emissions guidelines at the U.S. federal level as well as for California
- ② Engine number stamped into the crankcase
- ③ VIN (vehicle identification number) as a label at the lower edge of the windshield

Operating fluids

Notes on operating fluids

! NOTE Mercedes-AMG vehicles

- ▶ Observe the notes in the Supplement. You could otherwise fail to recognize dangers.

⚠ WARNING Risk of injury due to harmful operating fluids

Operating fluids can be toxic.

- ▶ When using, storing and disposing of operating fluids, observe the imprints on the respective original containers.
- ▶ Always keep operating fluids in the sealed original container.
- ▶ Always keep children away from operating fluids.



ENVIRONMENTAL NOTE Pollution of the environment due to irresponsible disposal of operating fluids

Incorrect disposal of operating fluids can cause considerable damage to the environment.

- ▶ Dispose of operating fluids in an environmentally responsible manner.

Operating fluids include the following:

- Fuels
- Lubricants
- Coolant
- Brake fluid
- Windshield washer fluid
- Climate control system refrigerant

Only use products approved by Mercedes-Benz. Damage caused by the use of products that have not been approved is not covered by the Mercedes-Benz warranty or goodwill gestures.

The operating fluids approved by Mercedes-Benz can be identified by the following inscriptions on the container:

- MB-Freigabe (e.g. MB-Freigabe 229.51)
- MB-Approval (e.g. MB-Approval 229.51)

Further information on approved operating fluids:

- in the Mercedes-Benz Specifications for Operating Fluids by entering the designation
 - At <https://operatingfluids.mercedes-benz.com>
- At a qualified specialist workshop

⚠ WARNING Risk of fire or explosion from fuel

Fuels are highly flammable.

- ▶ Fire, open flames, smoking and creating sparks must be avoided.
- ▶ Before and during refueling, switch off the vehicle and, if installed, the stationary heater.

▲ WARNING Risk of injury from fuels

Fuels are poisonous and hazardous to your health.

- ▶ Do not swallow fuel or let it come into contact with skin, eyes or clothing.
- ▶ Do not inhale fuel vapor.
- ▶ Keep children away from fuel.
- ▶ Keep doors and windows closed during the refueling process.

If you or other people come into contact with fuel, observe the following:

- ▶ Immediately rinse fuel off your skin with soap and water.
- ▶ If fuel comes into contact with your eyes, immediately rinse them thoroughly with clean water. Seek medical attention immediately.
- ▶ If you swallow fuel, seek medical attention immediately. Do not induce vomiting.

- ▶ Change immediately out of clothing that has come into contact with fuel.

Flexible-fuel vehicles can be refueled with the following fuel types:

- premium-grade unleaded gasoline
- E85 fuel
- a mixture of E85 fuel and premium-grade unleaded gasoline

Flexible-fuel vehicles can be identified by the **Ethanol up to E85** sticker on the inside of the fuel filler flap.

Depending on the country, the fuels you can use in your vehicle may differ from the information in the Operator's Manual. The fuels that have been approved for your vehicle can be found on the instruction label on the inside of the fuel filler flap.

Fuel**Information on fuel quality for vehicles with a gasoline engine**

Observe the notes on operating fluids (→ page 452).

! NOTE Damage caused by the wrong fuel

Even small amounts of the wrong fuel could result in damage to the fuel system, the engine and the emission control system.

- ▶ Only refuel with low-sulfur spark-ignition engine fuel.

This fuel may contain up to 10% ethanol by volume. Your vehicle is suitable for use with E10 fuel.

Never refuel with one of the following fuels:

- diesel
- Gasoline with more than 10% ethanol by volume, e.g. E15, E85, E100
- Gasoline with more than 3% methanol by volume, e.g. M15, M30, M85, M100

- Gasoline with additives containing metal

If you have accidentally refueled with the wrong fuel:

- ▶ Do not switch on the vehicle.
- ▶ Consult a qualified specialist workshop.

If the available fuel is not sufficiently low in sulfur, it may produce unpleasant odors.

Refuel using only fuel that has at least the octane number specified on the information label on the fuel filler flap (→ page 201). Otherwise, engine output may be reduced and fuel consumption increased.

For maximum engine output: refuel using only premium-grade unleaded gasoline with an octane number of at least 91 AKI/95 RON.

As a temporary measure, if the recommended fuel is not available, you may also refuel with regular unleaded gasoline with at least 87 AKI/91 RON. This may reduce engine output and increase fuel consumption.

Never refuel using gasoline with a lower RON.

! **NOTE** Premature engine wear through unleaded regular gasoline

Impairment of the longevity and performance of the engine.

If unleaded premium grade gasoline is unavailable and you have to refuel using unleaded regular gasoline:

- ▶ Only fill the fuel tank to half full with unleaded regular gasoline and refill as soon as possible with unleaded premium grade gasoline.
- ▶ Do not drive at the maximum design speed.
- ▶ Avoid sudden acceleration and engine speeds over 3000 rpm.

Further information on fuel is available at the following locations:

- At a gas station
- At a qualified specialist workshop
- On the <https://www.mbusa.com> (USA only)

Information on additives in gasoline (vehicles with gasoline engine)

Observe the notes on operating fluids (→ page 452).

! **NOTE** Damage from use of unsuitable additives

Even small amounts of the wrong additive may lead to malfunctions occurring.

- ▶ Only add cleaning additives recommended by Mercedes-Benz to the fuel.

Mercedes-Benz recommends that you use brand-name fuels with additives.

In some countries, the fuel available may not have sufficient additives. Deposits could build up in the fuel injection system as a result. In this case, in consultation with a qualified specialist workshop (e.g. an authorized Mercedes-Benz Service Center), mix the fuel with the cleaning additive recommended by Mercedes-Benz. Observe the notes and mixing ratios indicated on the tank.

Tank content and fuel reserve

Not for plug-in hybrid:

Total fuel tank capacity

Model	
All models	22.5 gal (85.0 liters)

Fuel tank reserve

Model	
All models	2.4 gal (9.0 liters)

Plug-in hybrid:**Total fuel tank capacity (plug-in hybrid)**

Model	
GLE 400 e 4MATIC	17.2 gal (65.0 liters)

Fuel tank reserve (plug-in hybrid)

Model	
GLE 400 e 4MATIC	2.4 gal (9.0 liters)

Engine oil**Notes on engine oil**

Observe the notes on operating fluids (→ page 452).



! **NOTE** Engine damage caused by an incorrect oil filter, incorrect oil or additives

- ▶ Do not use engine oils or oil filters other than those which meet the specifications necessary for the prescribed service intervals.

- ▶ Do not alter the engine oil or oil filter in order to achieve longer change intervals than prescribed.
- ▶ Do not use additives.
- ▶ Have the engine oil changed after the prescribed intervals.

Mercedes-Benz recommends having the oil changed at a qualified specialist workshop. Only use engine oils approved for your vehicle by Mercedes-Benz.

Engine oil quality and filling capacity

Missing values were not available at the time of going to press.

Not for plug-in hybrid:

Engine oil specifications (gasoline engines)

Model	MB-Freigabe or MB-Approval
GLE 450 4MATIC	
GLE 580 4MATIC	229.52 229.61*
All other models	229.51, 229.52, 229.61, 229.71 229.72*

* recommended for lowest possible fuel consumption (lowest SAE viscosity class in each case; observe possible restrictions of the approved SAE viscosity classes)

To achieve the lowest possible fuel consumption, it is recommended to use the engine oil specifications marked in the table with the lowest SAE viscosity class. Possible restrictions of the approved SAE viscosity classes must be observed.

Plug-in hybrid:**Engine oil specifications (plug-in hybrid)**

Model	MB-Freigabe or MB-Approval
GLE 400 e 4MATIC	

* recommended for lowest possible fuel consumption (lowest SAE viscosity class in each case; observe possible restrictions of the approved SAE viscosity classes)

To achieve the lowest possible fuel consumption, it is recommended to use the engine oil specifications marked in the table with the lowest SAE viscosity class. Possible restrictions of the approved SAE viscosity classes must be observed.

Not for plug-in hybrid:

The following values refer to an oil change, including the oil filter.

Engine oil filling capacity

Model	Capacity
GLE 450 4MATIC	Approx. 10.5 US qt (9.9 liters)
GLE 580 4MATIC	Approx. 10.0 US qt (9.5 liters)
All other models	Approx. 6.3 US qt (6.0 liters) or Approx. 7.4 US qt (7.0 liters)

Plug-in hybrid:

The following values refer to an oil change, including the oil filter.

Engine oil filling capacity (plug-in hybrid)

Model	Capacity
GLE 400 e 4MATIC	5.6 US qt (5.3 liters)

Notes on brake fluid

Observe the notes on operating fluids (→ page 452).

⚠ WARNING Risk of an accident due to vapor pockets forming in the brake system

The brake fluid constantly absorbs moisture from the air. This lowers the boiling point of the brake fluid. If the boiling point is too low, vapor pockets may form in the brake system when the brakes are applied hard.

This causes the braking effect to be impaired.

- ▶ Have the brake fluid renewed at the specified intervals.

Have the brake fluid regularly replaced at a qualified specialist workshop.

Only use a brake fluid approved by Mercedes-Benz according to MB-Freigabe or MB-Approval 331.0.

Coolant

■ Notes on coolant

Observe the notes on operating fluids (→ page 452).

⚠ WARNING - Risk of fire and injury from antifreeze

If antifreeze comes into contact with hot component parts in the engine compartment, it may ignite.

- ▶ Allow the engine to cool down before adding antifreeze.
- ▶ Make sure that no antifreeze spills out next to the filler opening.
- ▶ Thoroughly clean off any antifreeze from component parts before starting the vehicle.

! NOTE Damage caused by incorrect coolant

- ▶ Only use coolant that has been premixed with the required antifreeze protection.

Information on coolant is available at the following locations:

- In the Mercedes-Benz Specification for Operating Fluids 320.1
 - At <https://operatingfluids.mercedes-benz.com>
- At a qualified specialist workshop

! NOTE Overheating at high outside temperatures

If an inappropriate coolant is used, the cooling system is not sufficiently protected against overheating and corrosion at high outside temperatures.

- ▶ Only use coolant approved for Mercedes-Benz.
- ▶ Observe the instructions in the Mercedes-Benz Specifications for Operating Fluids 320.1.

Have the coolant regularly replaced at a qualified specialist workshop.

Proportion of antifreeze concentrate in the cooling system:

- A minimum of 50% (antifreeze protection down to about -35°F (-37°C))
- A maximum of 55% (antifreeze protection down to -49°F (-45°C))

Coolant filling capacity

Not for plug-in hybrid:

Coolant (engine)

Model	Capacity
GLE 350 GLE 350 4MATIC	13.7 US qt (13.0 liters) or 16.4 US qt (15.5 liters)
GLE 450 4MATIC	18.0 US qt (17.0 liters)
GLE 580 4MATIC	16.6 US qt (15.7 liters)

Plug-in hybrid:

Coolant (engine)

Model	Capacity
GLE 400 e 4MATIC	23.2 US qt (22.0 liters)

Notes on windshield washer fluid

Observe the notes on operating fluids (→ page 452).

⚠ WARNING - Risk of fire and injury from windshield washer concentrate

Windshield washer concentrate is highly flammable. It could ignite if it comes into contact with hot engine component parts or the exhaust system.

- ▶ Make sure that no windshield washer concentrate spills out next to the filler opening.

! **NOTE** Damage to the exterior lighting due to unsuitable windshield washer fluid

Unsuitable windshield washer fluid may damage the plastic surface of the exterior lighting.

- ▶ Only use windshield washer fluid which is also suitable for use on plastic surfaces, e.g. MB SummerFit or MB WinterFit.

! **NOTE** Blocked spray nozzles caused by mixing windshield washer fluids

- ▶ Do not mix MB SummerFit and MB WinterFit with other windshield washer fluids.

Do not use distilled or de-ionised water. Otherwise, the fill level sensor may be triggered erroneously.

Recommended windshield washer fluid:

- Above freezing point: e.g. MB SummerFit
- Below freezing point: e.g. MB WinterFit

For the correct mixing ratio, refer to the information on the antifreeze container.

Mix washing water with windshield washer fluid all year round.

Refrigerant

Notes on refrigerant

Observe the notes on operating fluids (→ page 452).

! NOTE Damage due to incorrect refrigerant

If a non-approved refrigerant is used, the climate control system may be damaged.

- ▶ **USA:** use only R-134a refrigerant.
- ▶ **Canada:** use only R-1234yf refrigerant.

! NOTE Damage to the climate control system due to incorrect refrigerant compressor oil

- ▶ Only use refrigerant compressor oil that has been approved by Mercedes-Benz.
- ▶ Do not mix the approved refrigerant compressor oil with a different refrigerant compressor oil.

Work on the climate control system may be carried out only at a qualified specialist workshop. All applicable regulations as well as SAE standard J639 must be adhered to.

The information label for the climate control system regarding the refrigerant type and the refrigerant compressor oil (PAG oil) is located on the inside of the hood.

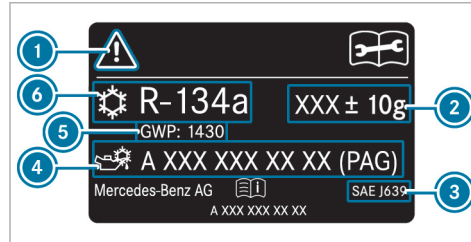

Information label (example - USA)

- ① Hazard and service warning symbols
- ② Refrigerant filling capacity
- ③ Applicable standards
- ④ PAG oil part number

- ⑤ GWP (global warming potential) of the refrigerant used
- ⑥ Refrigerant type

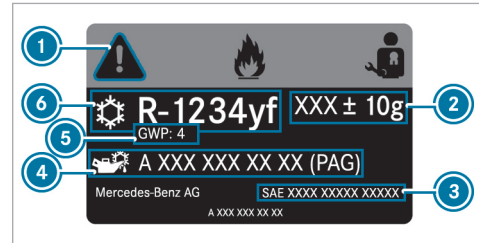

Information label (example - Canada)

- ① Hazard and service warning symbols
- ② Refrigerant filling capacity
- ③ Applicable standards
- ④ PAG oil part number
- ⑤ GWP (global warming potential) of the refrigerant used
- ⑥ Refrigerant type

Symbols ① indicate the following:

- Possible dangers
- Having maintenance work carried out at a qualified specialist workshop

Filling capacity for refrigerant and PAG oil

Not for plug-in hybrid:

Refrigerant filling capacity

Model	Capacity
All models	24.0 ± 0.4 oz (680 ± 10 g)

Filling capacity for PAG oil

Model	Capacity
GLE 450 4MATIC	4.9 ± 0.4 oz (140 ± 10 g)
All other models	2.8 ± 0.4 oz (80 ± 10 g)

Plug-in hybrid:

Refrigerant filling capacity (plug-in hybrid)

Model	Capacity
GLE 400 e 4MATIC	24.7 ± 0.4 oz (700 ± 10 g)

PAG oil filling capacity (plug-in hybrid)

Model	Capacity
GLE 400 e 4MATIC	2.8 ± 0.4 oz (80 ± 10 g)

Vehicle data

Vehicle dimensions

The heights specified may vary as a result of the following factors:

- Tires
- Load
- Condition of the suspension
- Optional equipment

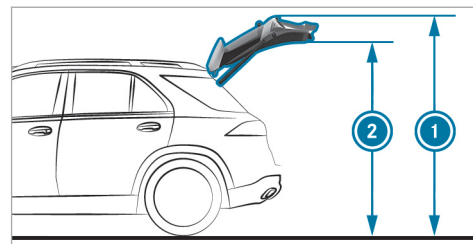

Not for plug-in hybrid:

Height when opened

	① Height when opened*	② Head-room*
Vehicles with steel suspension	87.3 in (2217 mm)	78.2 in (1986 mm)
Vehicles with AIR-MATIC	85.7 in (2178 mm) - 89.1 in (2263 mm)	76.7 in (1947 mm) - 80.0 in (2032 mm)

*When rear-end lowering is activated, the values will be lower accordingly.

Not for plug-in hybrid:

Vehicle dimensions

All models	
Vehicle length	193.9 in (4924 mm)
Vehicle length, AMG Styling	194.0 in (4927 mm)
Vehicle width including exterior mirrors	84.9 in (2157 mm)
Vehicle height (steel suspension)	70.7 in (1797 mm)
Maximum vehicle height (AIR-MATIC)	72.5 in (1842 mm)
Minimum vehicle height (normal level)	70.2 in (1782 mm)
Wheelbase	117.9 in (2995 mm)

All models	
Maximum ground clearance (steel suspension)	8.1 in (205 mm)
Maximum ground clearance (AIR-MATIC)	10.2 in (260 mm)
Minimum ground clearance (AIR-MATIC)	6.9 in (175 mm)
Turning radius	39.44 ft (12.02 m)
AMG Styling turning radius	39.53 ft (12.05 m)

Plug-in hybrid:

Height when opened and headroom (plug-in hybrid)

Model	① Height when opened*	② Headroom*
Vehicles with steel suspension	88.1 in (2238 mm)	79.1 in (2008 mm)
Vehicles with AIR-MATIC	85.7 in (2178 mm) - 89.1 in (2263 mm)	76.7 in (1947 mm) - 80.0 in (2032 mm)

*When rear-end lowering is activated, the values will be lower accordingly.

Vehicle dimensions (plug-in hybrid)

All models	
Vehicle length	193.9 in (4924 mm)
Vehicle width including exterior mirrors	84.9 in (2157 mm)

All models	
Vehicle height (steel suspension)	71.1 in (1807 mm)
Maximum vehicle height (AIR-MATIC)	72.5 in (1842 mm)
Minimum vehicle height (normal level)	70.2 in (1782 mm)
Wheelbase	117.9 in (2995 mm)
Maximum ground clearance (steel suspension)	8.1 in (205 mm)
Maximum ground clearance (AIR-MATIC)	9.4 in (240 mm)
Minimum ground clearance (AIR-MATIC)	6.1 in (155 mm)
Turning radius	39.44 ft (12.02 m)

Weights and loads

Please observe the following notes for the specified vehicle data:

- Items of optional equipment increase the curb weight and reduce the payload.
- You will find vehicle-specific weight information on the vehicle identification plate (→ page 450).

Not for plug-in hybrid:

Roof load

Model	Maximum roof load
All models	220.5 lb (100 kg)

Plug-in hybrid:

Roof load (plug-in hybrid)

Model	Maximum roof load
All models	220.5 lb (100 kg)

Off-road driving

Fording depth

! **NOTE** Damage caused by water when fording

In the following cases water can penetrate into the engine compartment and vehicle interior:

- The maximum permissible fording depth is exceeded when driving through standing water.
- When driving through the water a bow wave forms.
- Water accumulates when driving through running water.

▶ Do not exceed the maximum permissible fording depth and drive slowly through the water.

The specified value indicates the maximum permissible fording depth for vehicles that are in roadworthy condition and for slow driving through standing water.

Driving through flowing water reduces the permissible fording depth due to the accumulation of water.

Observe the notes on off-road driving and fording (→ page 180).

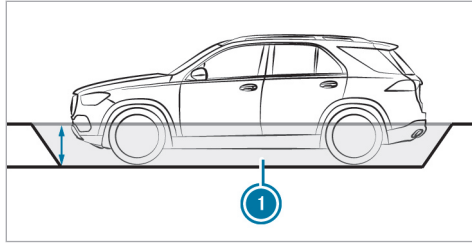

Not for plug-in hybrid:

Fording depth

Model	1 Fording depth
Vehicles with steel suspension	19.7 in (50 cm)
Vehicles with AIRMATIC	
Raised level	19.7 in (50 cm)

Plug-in hybrid:

Fording depth (plug-in hybrid)

Model	1 Fording depth
GLE 400 e 4MATIC	19.7 in (50 cm)

Angle of approach/departure

The specified values are maximum values for vehicles that are in ready-to-drive condition.

Observe the notes on driving in mountainous terrain (→ page 180).

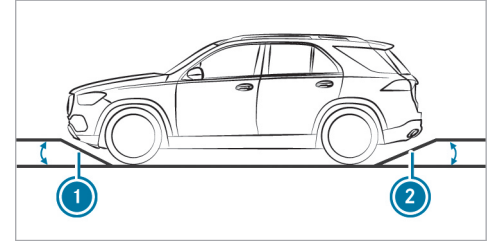

Not for plug-in hybrid:

Angle of approach/departure (vehicles without AMG Styling)

All models	1 Angle of approach	2 Angle of departure
Vehicles with steel suspension*	25°	25°
Vehicles with AIRMATIC*		
Standard level	25°	24°
Raised level	29°	28°

Angle of approach/departure (vehicles with AMG Styling)

All models	① Angle of approach	② Angle of departure
Vehicles with steel suspension	21°	24°
Vehicles with AIR-MATIC		
Standard level	21°	24°
Raised level	25°	27°

*Depending on the tire size

Plug-in hybrid:

Angle of approach/departure (plug-in hybrid vehicles without AMG Styling)

GLE 400 e 4MATIC	① Angle of approach	② Angle of departure
Vehicles with steel suspension*	25°	26°
Vehicles with AIR-MATIC*		
Standard level	25°	24°
Raised level	29°	28°

Angle of approach/departure (plug-in hybrid vehicles with AMG Styling)

GLE 400 e 4MATIC	① Angle of approach	② Angle of departure
Vehicles with steel suspension	21°	26°
Vehicles with AIR-MATIC		

GLE 400 e 4MATIC	① Angle of approach	② Angle of departure
Standard level	21°	24°
Raised level	25°	27°

*Depending on the tire size

Maximum gradient-climbing ability

The vehicle's gradient-climbing ability depends on the weight distribution in the vehicle, the terrain conditions and the road surface conditions.

The specified value applies in the following cases:

- the vehicle is ready to drive
- the road surface conditions and thus traction are good

A gradient-climbing ability of 100% corresponds to an incline of 45°.

Observe the notes on driving in mountainous terrain (→ page 180).

Not for plug-in hybrid:

Gradient-climbing ability

Model	Maximum gradient-climbing ability
All models	80%

Plug-in hybrid:**Gradient-climbing ability (plug-in hybrid)**

Model	Maximum gradient-climbing ability
GLE 400 e 4MATIC	80%

High-voltage battery (plug-in hybrid)

Missing values were not available at the time of going to press.

Energy content and charging times

GLE 400 e 4MATIC	
Type	Lithium-ion
Maximum energy content	31.2 kWh
Range in all-electric mode	
Charging time – mode 4 with 60 kW charging capacity	Approx. 20 min
Charging time – mode 3 with 9.6 kW charging capacity	Approx. 2 h 30 min
Charging time – mode 2 with 1.4 kW charging capacity	Approx. 24

Charging times – modes 2 and 3 apply to AC charging from 10% to 100% of the usable energy content.

Charging time – mode 4 applies to DC charging from 10% to 80% of the usable energy content.

The time taken to charge the battery depends on the state of charge of the battery, the ambient temperature and the charging capacity of the bat-

tery. The charging capacity, in turn, depends on the supply voltage, the current intensity and the type of power supply.

The rated voltage range for your vehicle can be found on the information label on the socket cover.

Trailer hitch**General notes on the trailer hitch**

Modifications to the cooling system may be necessary, depending on the vehicle model. Retrofitting a trailer hitch is permissible only if a trailer load is specified in your vehicle documents.

Further information can be obtained at a qualified specialist workshop.

Observe the information and notes on the trailer hitch (→ page 301).

Towing capacity**Not for plug-in hybrid:**

The tongue weight is not included in the towing capacity.

Towing capacity, braked

Model	Towing capacity, braked
GLE 350	5952.5 lbs (2700 kg)
All other models	7716.2 lbs (3500 kg)

Plug-in hybrid:**Towing capacity, braked**

Model	Towing capacity, braked
GLE 400 e 4MATIC	7716.2 lbs (3500 kg)

Maximum tongue weight and load capacity

! **NOTE** Damage caused by the trailer coming loose

If the tongue weight used is too low, the trailer may come loose.

► The tongue weight must not be below 110.2 lbs (50 kg).

► Use a tongue weight that is as close as possible to the maximum permissible tongue weight.

! **NOTE** Damage caused by the bicycle rack coming loose

When using a bicycle rack, both the maximal tongue weight and the maximal load capacity should be observed.

► Do not exceed the permissible load capacity.

Not for plug-in hybrid:**Tongue weight**

Model	Maximum tongue weight
GLE 350	476.2 lbs (216 kg)
All other models	617.3 lbs (280 kg)

Load capacity

All models	Maximum load capacity
When the bicycle rack is attached to the ball head	165.3 lbs (75 kg)
When the bicycle rack is attached to the ball head and additionally to the guide pins	220.5 lbs (100 kg)

Plug-in hybrid:**Tongue weight (plug-in hybrid)**

Model	Maximum tongue weight
GLE 400 e 4MATIC	617.3 lbs (280 kg)

Load capacity (plug-in hybrid)

GLE 400 e 4MATIC	Maximum load capacity
When the bicycle rack is attached to the ball head	165.3 lbs (75 kg)
When the bicycle rack is attached to the ball head and additionally to the guide pins	220.5 lbs (100 kg)

Display messages



Introduction



Information about display messages

Display messages appear on the driver's display. Display messages with graphical symbols are simplified in the Operator's Manual and may differ from the symbols on the driver's display. The driver's display shows high-priority display messages in red. Certain display messages are accompanied by a warning tone.

Please act in accordance with the display messages and follow the additional notes in the Operator's Manual.

For some display messages, symbols will also be shown:

-  Further information
-  Hide display message

With the left-hand Touch Control, you can select the respective symbol by swiping to the left or right. Pressing  displays further information on the central display. Press the  symbol to hide the display message.

Display messages to be acknowledged can be hidden by pressing the back button  or with the left-hand Touch Control. The display messages will then be stored in the message memory.

Rectify the cause of a display message as quickly as possible.

High-priority display messages cannot be hidden. The driver's display will show these display messages continuously until the cause of the display message has been rectified.

Calling up saved display messages

Driver's display:



The **Message Memory: XX** message appears on the driver's display.

- ▶ Scroll through the display messages by swiping upwards or downwards on the left-hand Touch Control.
- ▶ **To exit the display:** press the  back button.

Occupant safety

Display messages	Possible causes/consequences and ► Solutions
 <p data-bbox="195 381 463 430">Restraint System Malfunction Service Required</p>	<p data-bbox="526 288 1055 313">* The restraint system is malfunctioning (→ page 47).</p> <div data-bbox="550 332 1698 449" style="border: 1px solid gray; padding: 5px;"> <p data-bbox="559 339 1262 365">▲ WARNING Risk of injury due to malfunctions in the restraint system</p> <p data-bbox="559 379 1628 405">Components in the restraint system may be activated unintentionally or not deploy as planned in an accident.</p> <ul style="list-style-type: none"> <li data-bbox="559 415 1522 441">► Have the restraint system checked and repaired immediately at a qualified specialist workshop. </div> <p data-bbox="543 467 685 493">Plug-in hybrid:</p> <div data-bbox="550 511 1698 746" style="border: 1px solid gray; padding: 5px;"> <p data-bbox="559 519 1245 544">▲ DANGER Risk of death due to the restraint system malfunctioning</p> <p data-bbox="559 558 1659 610">Components in the restraint system may be activated unintentionally or not deploy as intended in an accident. In the event of an accident, the high-voltage on-board electrical system may not be deactivated as intended.</p> <p data-bbox="559 622 1650 669">You may receive an electric shock if you touch the damaged components of the high-voltage on-board electrical system.</p> <ul style="list-style-type: none"> <li data-bbox="559 679 1522 705">► Have the restraint system checked and repaired immediately at a qualified specialist workshop. <li data-bbox="559 715 1114 741">► After an accident, switch off the vehicle immediately. </div>

Display messages



Front Left Malfunction
Service Required (example)

Possible causes/consequences and ► Solutions

* The restraint system is malfunctioning (→ page 47).

▲ WARNING Risk of injury due to malfunctions in the restraint system

Components in the restraint system may be activated unintentionally or not deploy as planned in an accident.

- Have the restraint system checked and repaired immediately at a qualified specialist workshop.

Plug-in hybrid:

▲ DANGER Risk of death due to the restraint system malfunctioning

Components in the restraint system may be activated unintentionally or not deploy as intended in an accident. In the event of an accident, the high-voltage on-board electrical system may not be deactivated as intended.



You may receive an electric shock if you touch the damaged components of the high-voltage on-board electrical system.



- Have the restraint system checked and repaired immediately at a qualified specialist workshop.
- After an accident, switch off the vehicle immediately.

Display messages	Possible causes/consequences and ► Solutions
 <p data-bbox="194 341 443 424">Left Window Airbag Malfunction Service Required (example)</p>	<p data-bbox="526 248 1053 274">* The restraint system is malfunctioning (→ page 47).</p> <div data-bbox="545 290 1690 429" style="border: 1px solid gray; padding: 5px;"> <p data-bbox="554 295 1469 326">▲ WARNING Risk of injury or fatal injury due to a malfunction in the window curtain airbag</p> <p data-bbox="554 336 1635 388">The window curtain airbag might be triggered unintentionally or might not be triggered at all in the event of an accident.</p> <p data-bbox="554 398 1580 424">► Have the window curtain airbag checked and repaired immediately at a qualified specialist workshop.</p> </div>
<p data-bbox="194 450 480 528">Front Passenger Airbag Disabled See Operator's Manual</p>	<p data-bbox="526 450 1598 502">* The front passenger air bag has been disabled even though an adult or a person of adult build is on the front passenger seat. If additional forces are applied to the seat, the weight the system detects may be too low.</p> <div data-bbox="545 518 1690 725" style="border: 1px solid gray; padding: 5px;"> <p data-bbox="554 523 1376 554">▲ WARNING Risk of injury or fatal injury due to a disabled front passenger airbag</p> <p data-bbox="554 564 1681 616">If the front passenger airbag is disabled, the front passenger airbag will not be deployed in the event of an accident and cannot perform its intended protective function.</p> <p data-bbox="554 626 1653 678">A person in the front passenger seat could then, for example, come into contact with the vehicle's interior, especially if the person is sitting too close to the cockpit.</p> <p data-bbox="554 688 1598 714">► Make sure, both before and during the journey, that the status of the front passenger airbag is correct.</p> </div> <ul data-bbox="545 740 1358 870" style="list-style-type: none"> <li data-bbox="545 740 1265 766">► Stop the vehicle immediately in accordance with the traffic conditions. <li data-bbox="545 771 1265 797">► Make sure that no objects are trapped under the front passenger seat. <li data-bbox="545 802 1358 833">► Check the status of the automatic front passenger air bag shutoff (→ page 49). <li data-bbox="545 839 1210 870">► If necessary, consult a qualified specialist workshop immediately.

Display messages	Possible causes/consequences and ► Solutions
<p>Front Passenger Airbag Enabled See Operator's Manual</p>	<p>* The front passenger air bag will be enabled while the vehicle is in motion in the following situations:</p> <ul style="list-style-type: none">• even when a child, a small adult or an object weighing less than the system weight threshold is located on the front passenger seat• even when the front passenger seat is not occupied <p>The system may detect objects or forces that are adding to the weight applied to the seat.</p> <p>▲ WARNING Risk of injury or death when using a child restraint system while the front passenger airbag is enabled</p> <p>If you secure a child in a child restraint system on the front passenger seat and the front passenger airbag is enabled, the front passenger airbag can deploy in the event of an accident. The child could be struck by the airbag.</p> <p>► Ensure, both before and during the journey, that the status of the front passenger airbag is correct.</p> <p>NEVER use a rearward facing child restraint on a seat protected by an ACTIVE AIRBAG in front of it, DEATH or SERIOUS INJURY to the CHILD can occur.</p> <ul style="list-style-type: none">► Stop the vehicle immediately in accordance with the traffic conditions.► Make sure that no objects are trapped under the front passenger seat.► Check the status of the automatic front passenger air bag shutoff (→ page 49).► If necessary, consult a qualified specialist workshop immediately.

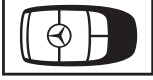
SmartKey





Display messages	Possible causes/consequences and ► Solutions
 <p data-bbox="195 381 376 407">Obtain a New Key</p>	<ul style="list-style-type: none"> <li data-bbox="519 291 768 317">* Have the key replaced. <li data-bbox="543 322 966 348">► Consult a qualified specialist workshop.
 <p data-bbox="195 526 402 552">Replace Key Battery</p>	<ul style="list-style-type: none"> <li data-bbox="519 433 837 458">* The key battery is discharged. <li data-bbox="543 464 911 490">► Replace the battery (→ page 78).
 <p data-bbox="195 671 439 717">Key Not Detected (white display message)</p>	<ul style="list-style-type: none"> <li data-bbox="519 578 855 603">* The key is currently undetected. <li data-bbox="543 609 1021 635">► Change the location of the key in the vehicle. <li data-bbox="543 640 805 666">► Try to start the vehicle. <li data-bbox="543 671 1434 697">► If the key is still not detected, place it in the slot for starting with the key (→ page 173). <li data-bbox="543 702 750 728">► Start the vehicle.



Display messages	Possible causes/consequences and ► Solutions
 <p data-bbox="144 342 413 394">Key Not Detected (red display message)</p>	<p data-bbox="469 249 1350 275">* The key can no longer be detected during a journey and may no longer be in the vehicle.</p> <p data-bbox="493 283 1138 309">If the key is no longer in the vehicle and you switch off the vehicle:</p> <ul data-bbox="500 318 892 377" style="list-style-type: none"><li data-bbox="500 318 874 343">• You can no longer start the vehicle.<li data-bbox="500 351 892 377">• You cannot centrally lock the vehicle. <p data-bbox="493 391 881 417">► Ensure that the key is in the vehicle.</p> <p data-bbox="493 443 981 469">If the key is in the vehicle and is still not detected:</p> <ul data-bbox="493 477 1258 539" style="list-style-type: none"><li data-bbox="493 477 1215 503">► Stop the vehicle immediately in accordance with the traffic conditions.<li data-bbox="493 510 1258 536">► Place the key in the slot for starting the engine with the key (→ page 173). <p data-bbox="493 562 868 588">The key battery is weak or discharged.</p> <ul data-bbox="493 596 1084 658" style="list-style-type: none"><li data-bbox="493 596 1084 622">► Check the battery using the indicator lamp (→ page 76).<li data-bbox="493 629 1027 655">► Replace the key battery, if necessary (→ page 78).
 <p data-bbox="144 767 413 793">Initializing Key Please Wait</p>	<p data-bbox="469 674 1055 700">* The vehicle is processing in order to teach in the new key.</p> <ul data-bbox="493 708 857 734" style="list-style-type: none"><li data-bbox="493 708 857 734">► Wait until processing is complete.

Display messages	Possible causes/consequences and ► Solutions
 <p data-bbox="195 339 421 365">Don't Forget Your Key</p>	<p data-bbox="522 249 1628 275">* A warning tone will also sound. This message reminds you to take your key with you when you leave the vehicle.</p>
<p data-bbox="195 389 463 464">Place the Key in the Marked Space See Operator's Manual</p>	<p data-bbox="522 389 857 415">* Key detection is malfunctioning.</p> <ul style="list-style-type: none"> <li data-bbox="543 422 1018 448">► Change the location of the key in the vehicle. <li data-bbox="543 455 1308 481">► Place the key in the slot for starting the engine with the key (→ page 173).

Lights

Display messages	Possible causes/consequences and ► Solutions
 <p data-bbox="195 717 356 769">Check Left Low Beam (example)</p>	<p data-bbox="522 627 1023 653">* The corresponding light source is malfunctioning.</p> <ul style="list-style-type: none"> <li data-bbox="543 660 759 686">► Drive on carefully. <li data-bbox="543 694 1086 720">► Consult a qualified specialist workshop immediately. <li data-bbox="543 727 1689 779">ⓘ LED light sources: the display message for the corresponding light appears only when all the light-emitting diodes in the light are faulty.

Display messages	Possible causes/consequences and ► Solutions
 <p>Malfunction See Operator's Manual</p>	<ul style="list-style-type: none">* The exterior lighting is malfunctioning.<ul style="list-style-type: none">► Consult a qualified specialist workshop.
 <p>Automatic Driving Lights Inoperative</p>	<ul style="list-style-type: none">* The light sensor for automatic driving lights is malfunctioning.<ul style="list-style-type: none">► Consult a qualified specialist workshop.
 <p>Active Headlamps Inoperative</p>	<ul style="list-style-type: none">* The active headlamps are malfunctioning.<ul style="list-style-type: none">► Consult a qualified specialist workshop.
 <p>Switch On Headlights</p>	<ul style="list-style-type: none">* You are driving without low-beam headlamps.<ul style="list-style-type: none">► Turn the light switch to the  or AUTO position.



Display messages	Possible causes/consequences and ► Solutions
 <p data-bbox="194 336 369 367">Switch Off Lights</p>	<ul style="list-style-type: none"> * You are leaving the vehicle and the lights are still switched on. <ul style="list-style-type: none"> ► Turn the light switch to the AUTO position.
 <p data-bbox="194 481 471 533">Dynamic Low Beam Inoperative</p>	<ul style="list-style-type: none"> * The Dynamic Low Beam is malfunctioning. The lighting system continues to function properly without the functions of the Dynamic Low Beam. <ul style="list-style-type: none"> ► Consult a qualified specialist workshop.
<p data-bbox="194 559 462 637">Adaptive Highbeam Assist Currently Unavailable See Operator's Manual</p>	<ul style="list-style-type: none"> * Adaptive Highbeam Assist is temporarily unavailable. The system limits have been reached (→ page 144). Once the cause of the problem is no longer present, the system will be available again. The Adaptive Highbeam Assist Now Available display message will appear. <ul style="list-style-type: none"> ► Drive on. ► Operate the high beam manually until Adaptive Highbeam Assist is available again.
<p data-bbox="194 766 462 813">Adaptive Highbeam Assist Inoperative</p>	<ul style="list-style-type: none"> * Adaptive Highbeam Assist is malfunctioning. <ul style="list-style-type: none"> ► Drive on or

478 Display messages and warning/indicator lamps



Display messages	Possible causes/consequences and ► Solutions
	<ul style="list-style-type: none">► Stop the vehicle in accordance with the traffic conditions and restart the vehicle.► If the display message does not disappear: consult a qualified specialist workshop.► Until then, operate the high beam manually.
Hazard Warning Light Malfunction	<ul style="list-style-type: none">* The hazard warning lamp switch is malfunctioning.► Consult a qualified specialist workshop.

Climate control

Display messages	Possible causes/consequences and ► Solutions
 Currently Not Available Charging of the High-voltage Battery Not Completed	<ul style="list-style-type: none">* The high-voltage battery is charging. Pre-entry climate control cannot be switched on.► Wait until the charging process has achieved a minimum condition of charge.



Display messages	Possible causes/consequences and ► Solutions
 <p data-bbox="195 342 449 420">Currently Not Available Charge High-voltage Battery</p>	<ul style="list-style-type: none"> * The charge of the high-voltage battery is too low. Pre-entry climate control cannot be switched on. <ul style="list-style-type: none"> ► Charge the high-voltage battery (→ page 204).
 <p data-bbox="195 536 458 614">Pre-entry Climate Control Available Again via Smart- Key after Vehicle Start</p>	<ul style="list-style-type: none"> * You have attempted to switch on pre-entry climate control more than twice with the vehicle switched off. <ul style="list-style-type: none"> ► Start the vehicle for ten seconds. Pre-entry climate control is operational again.
 <p data-bbox="195 730 473 835">Pre-entry Climate Control via SmartKey Currently Not Available. High-voltage Battery Low</p>	<ul style="list-style-type: none"> * The charge of the high-voltage battery is too low. Pre-entry climate control cannot be switched on. <ul style="list-style-type: none"> ► Charge the high-voltage battery (→ page 204). When the high-voltage battery is sufficiently charged, pre-entry climate control will be operational again.



Hybrid system



Display messages	Possible causes/consequences and ► Solutions
 <p data-bbox="144 381 413 433">Towing Not Permitted See Operator's Manual</p>	<ul style="list-style-type: none"> * The drive system is malfunctioning. <ul style="list-style-type: none"> ► Have the vehicle transported only using a transporter or trailer (→ page 405).
 <p data-bbox="144 550 413 601">Acoustic Presence Indicator Inoperative</p>	<ul style="list-style-type: none"> * The sound generator (acoustic vehicle warning system) is malfunctioning. No vehicle noises are being produced. The vehicle may not be heard by other road users. <ul style="list-style-type: none"> ► Drive with particular care. ► Consult a qualified specialist workshop.
 <p data-bbox="144 718 413 743">Charger Cable Connected</p>	<ul style="list-style-type: none"> * You cannot pull away while the charging cable is connected. <ul style="list-style-type: none"> ► Disconnect the charging cable from the vehicle.
<p data-bbox="144 767 413 840">Not Possible to Unlock Charging Cable See Operator's Manual</p>	<ul style="list-style-type: none"> * The charging cable connector cannot be removed from the charging station's socket. <ul style="list-style-type: none"> ► Press the EMERGENCY OFF switch on the charging station. <p data-bbox="495 850 1097 878">If the charging cable connector cannot be removed after that:</p>

Display messages	Possible causes/consequences and ► Solutions
	<ul style="list-style-type: none"> ► Request service personnel from the operator of the charging station via the emergency call button or the emergency numbers attached to the charging station.
<p>Vehicle Currently Not Charging... Charging Station Fault</p>	<ul style="list-style-type: none"> * A malfunction has occurred in the charging station or the RFID card is not recognized. <ul style="list-style-type: none"> ► Start the charging process at a different charging station. or ► Have the RFID card checked to ensure it is functioning.
<p>Charging Mode Currently Unavailable Try Again or Change Charging Mode</p>	<ul style="list-style-type: none"> * A temporary malfunction has occurred in the charging station. <ul style="list-style-type: none"> ► Wait until the malfunction has passed. or ► Start the charging process at a different charging station.
<p>Charging Fault Change Charging Mode See Operator's Manual</p>	<ul style="list-style-type: none"> * A temporary malfunction has occurred in the charging station. <ul style="list-style-type: none"> ► Wait until the malfunction has passed. or ► Start the charging process at a different charging station.
<p>Only Electric Drive Available Power Limited</p>	<ul style="list-style-type: none"> * The fuel tank is empty and the combustion engine is switched off. The output of your vehicle is limited because you are driving in electric mode.

Display messages	Possible causes/consequences and ► Solutions
	<ul style="list-style-type: none"> ► Refuel immediately. Subsequently, there may be temporary restrictions in the availability of electric mode over a driving distance of 31 mi (50 km). <p>If there is fuel in the vehicle, there is a malfunction with the combustion engine.</p> <ul style="list-style-type: none"> ► Consult a qualified specialist workshop.
"Electric" Drive Program Currently Unavailable	<p>* The condition of charge of the high-voltage battery is not sufficient for the Electric drive program. Charge the high-voltage battery (→ page 204).</p>
Reduced Drive System Performance See Operator's Manual	<p>* The drive system switches to emergency operation mode due to a malfunction.</p> <ul style="list-style-type: none"> ► Drive on carefully. ► Consult a qualified specialist workshop.
 <p>Battery Overheated Stop! Everyone Get Out! Outdoors if Possible</p>	<p>* Plug-in hybrid: the high-voltage battery has overheated. There is a risk of fire.</p> <ul style="list-style-type: none"> ► Stop the vehicle immediately in accordance with the traffic conditions. ► If possible, stop the vehicle in the open air and ensure that all vehicle occupants get out. ⓘ Supporting vehicle functions may activate automatically, e.g. air-recirculation mode as part of climate control. ► Do not continue driving. ► If smoke is present, leave the danger zone and call the fire service immediately. ► Consult a qualified specialist workshop even if there are no external signs of a fire.

Display messages	Possible causes/consequences and ► Solutions
 <p data-bbox="194 341 323 362">Malfunction</p>	<ul style="list-style-type: none"> * The drive system is malfunctioning. A warning tone will also sound. <ul style="list-style-type: none"> ► Consult a qualified specialist workshop.
 <p data-bbox="194 481 397 533">Malfunction Service Required</p>	<ul style="list-style-type: none"> * The drive system is malfunctioning. <ul style="list-style-type: none"> ► Consult a qualified specialist workshop.
<p data-bbox="194 559 471 611">Do Not Shift Gears Service Required</p>	<ul style="list-style-type: none"> * The drive system cannot be restarted due to a malfunction. If the transmission position is changed using the DIRECT SELECT lever, the drive system will be switched off in park position P or neutral N. <ul style="list-style-type: none"> ► Consult a qualified specialist workshop and do not change the transmission position.
<p data-bbox="194 694 434 745">Do Not Restart Vehicle Service Required</p>	<ul style="list-style-type: none"> * It is not possible to restart the drive system due to a malfunction. <ul style="list-style-type: none"> ► Do not switch off the drive system; drive on to the nearest qualified specialist workshop.

Display messages	Possible causes/consequences and ► Solutions
 <p>Malfunction</p>	<ul style="list-style-type: none">* The drive system is malfunctioning. The output of your vehicle is restricted.<ul style="list-style-type: none">► Consult a qualified specialist workshop.
 <p>Stop Switch Off Vehicle</p>	<ul style="list-style-type: none">* The drive system is malfunctioning.<ul style="list-style-type: none">► Stop the vehicle immediately in accordance with the traffic conditions and switch off the drive system. Do not continue driving.► Do not tow the vehicle; stop towing if necessary.► Consult a qualified specialist workshop.
 <p>Performance Extremely Limited</p>	<ul style="list-style-type: none">* The drive system is outside the normal operating temperature range, e.g. due to extremely low or high outside temperatures. The output is severely restricted. Once the operating temperature of the drive system returns to normal, the full output will be available again. The display message will disappear.* If the drive system power output is still reduced, there is a malfunction in the drive system.<ul style="list-style-type: none">► Drive on carefully.► Consult a qualified specialist workshop.

Display messages	Possible causes/consequences and ► Solutions
 <p data-bbox="195 342 469 389">Please Wait Depressurizing Fuel Tank</p>	<p data-bbox="524 249 1674 296">* Vehicles with gasoline engine: The pressure in the fuel tank is reduced before the fuel filler flap is opened. This pressure reduction can take up to 15 minutes.</p>
 <p data-bbox="195 514 469 561">Fuel Tank Is Depressurized Ready for Refueling</p>	<p data-bbox="524 421 1511 441">* Vehicles with gasoline engine: The pressure in the fuel tank is released and the fuel filler flap opens.</p>
 <p data-bbox="195 680 454 727">Tank Ventilation Malfunction Service Required</p>	<p data-bbox="524 587 1241 607">* Vehicles with gasoline engine: There is a malfunction in the fuel system.</p> <p data-bbox="543 620 964 640">► Consult a qualified specialist workshop.</p>

Vehicle

Display messages



Possible causes/consequences and ► Solutions

- * The driver's display is inoperative due to a failed software update.
The display message will be shown every time the engine is started.

⚠ WARNING Risk of accident if the driver display fails

If the driver display has failed or is malfunctioning, function restrictions in systems relevant to safety cannot be detected.

The operating safety of your vehicle may be impaired.

- Drive on carefully.
- Have the vehicle checked immediately at a qualified specialist workshop.

If the operating safety of your vehicle is impaired, park the vehicle immediately and safely. Contact a qualified specialist workshop.



Plug-in hybrid:
⚠ WARNING Risk of accident due to failure of the driver display



In the event that the driver display fails or malfunctions, you will not recognize function restrictions affecting systems relevant to safety. This may impair operating safety.



- Park the vehicle safely as soon as possible and notify a qualified specialist workshop.



Display messages	Possible causes/consequences and ► Solutions
	<p>If the driver's display fails, you may not recognize function restrictions affecting systems relevant to safety or the speed display, for example. The operating safety of the vehicle may be impaired (→ page 333).</p> <ul style="list-style-type: none"> ► Have the vehicle checked by a qualified specialist workshop immediately.
 <p data-bbox="195 443 439 544">Vehicle Ready to Drive Shutdown Occurs When Locked or After a Few Minutes</p>	<ul style="list-style-type: none"> * You are leaving the vehicle in a ready-to-drive state. <ul style="list-style-type: none"> ► Get out of the vehicle, secure it against rolling away and take the key with you. ► If you do not leave the vehicle, switch off the electrical consumers, e.g. the seat heating. Otherwise, the 12-V battery may discharge and starting the engine may be possible only with the help of a second battery (jump start).
<p data-bbox="195 570 463 672">Vehicle Ready to Drive Shutdown Occurs When Locked or Automatically in XX Mins</p>	<ul style="list-style-type: none"> * You are about to leave the vehicle and the engine is running. The vehicle will switch off automatically in 20 minutes. <ul style="list-style-type: none"> ► To prevent the vehicle from switching off automatically, confirm the message in the central display of the multimedia system. * You are in the vehicle. Park position P is engaged and the engine is running. After the vehicle is stationary for a certain length of time, this display message appears in the driver's display. The vehicle will then switch off automatically after it has been stationary for a period of 20 minutes. <ul style="list-style-type: none"> ► To prevent the vehicle from switching off automatically, confirm the message in the central display of the multimedia system.

Display messages	Possible causes/consequences and ► Solutions
<p>Head-up Display Currently Unavailable See Operator's Manual</p>	<p>* The head-up display is temporarily unavailable. Possible causes are:</p> <ul style="list-style-type: none">• malfunctions in the power supply• signal interference <p>► Stop in accordance with the traffic conditions and switch the vehicle off and on again.</p> <p>► If the display message still appears, consult a qualified specialist workshop.</p>
<p>Head-up Display Inoperative</p>	<p>* The head-up display has an internal error.</p> <p>► Consult a qualified specialist workshop.</p>
<p></p> <p>Steering Malfunction Increased Physical Effort See Operator's Manual</p>	<p>* The power steering assistance is malfunctioning.</p> <p>▲ WARNING Risk of an accident due to altered steering characteristics</p> <p>If the power assistance of the steering fails partially or completely, you will need to use more force to steer.</p> <p>► If safe steering is possible, drive on carefully.</p> <p>► Visit or consult a qualified specialist workshop immediately.</p>

Display messages	Possible causes/consequences and ► Solutions
 <p data-bbox="195 342 463 417">Steering Malfunction Stop Immediately See Operator's Manual</p>	<p data-bbox="524 250 1271 274">* The steering is malfunctioning. Steering capability is significantly impaired.</p> <div data-bbox="550 291 1696 467" style="border: 1px solid gray; padding: 5px;"> <p data-bbox="559 298 1182 326">▲ WARNING Risk of accident if steering capability is impaired</p> <p data-bbox="559 339 1437 367">If the steering does not function as intended, the vehicle's operating safety is jeopardized.</p> <ul style="list-style-type: none"> <li data-bbox="559 373 1641 425">▶ Pull over and stop the vehicle safely as soon as possible, paying attention to road and traffic conditions. Do not continue driving under any circumstances. <li data-bbox="559 433 984 461">▶ Consult a qualified specialist workshop. </div>
	<p data-bbox="524 483 796 511">* At least one door is open.</p> <ul style="list-style-type: none"> <li data-bbox="541 519 735 547">▶ Close all doors.
	<p data-bbox="524 592 722 620">* The hood is open.</p> <div data-bbox="550 637 1696 785" style="border: 1px solid gray; padding: 5px;"> <p data-bbox="559 644 1240 672">▲ WARNING Risk of accident due to driving with the hood unlocked</p> <p data-bbox="559 685 962 713">The hood may open and block your view.</p> <ul style="list-style-type: none"> <li data-bbox="559 720 962 747">▶ Never release the hood when driving. <li data-bbox="559 755 1073 783">▶ Before every trip, ensure that the hood is locked. </div> <ul style="list-style-type: none"> <li data-bbox="541 806 1267 833">▶ Stop the vehicle immediately in accordance with the traffic conditions. <li data-bbox="541 841 735 869">▶ Close the hood.

Display messages	Possible causes/consequences and ► Solutions
	<p>* The tailgate is open.</p> <div style="border: 1px solid gray; padding: 5px; margin: 5px 0;"> <p>▲ DANGER Risk of exhaust gas poisoning</p> <p>Combustion engines emit poisonous exhaust gases such as carbon monoxide. Exhaust gases can enter the vehicle interior if the tailgate is open when the engine is running, especially if the vehicle is in motion.</p> <ul style="list-style-type: none"> ▶ Always switch off the engine before opening the tailgate. ▶ Never drive with the tailgate open. </div> <p>► Close the tailgate.</p>
 <p>2nd Seat Row, Left Not Locked</p>	<p>* The left-hand seat or the seat backrest in the second row of seats is not engaged.</p> <ul style="list-style-type: none"> ► Fold the corresponding seat backrest back until it engages and push the row of seats back (→ page 106). ► Make sure that the seat is engaged (→ page 106).
 <p>2nd Seat Row, Right Not Locked</p>	<p>* The right-hand seat or the seat backrest in the second row of seats is not engaged.</p> <ul style="list-style-type: none"> ► Fold the corresponding seat backrest back until it engages and push the row of seats back (→ page 106). ► Make sure that the seat is engaged (→ page 106).



Display messages	Possible causes/consequences and ► Solutions
 <p data-bbox="194 341 462 393">2nd Seat Row, Center Not Locked</p>	<ul style="list-style-type: none">* The seat backrest of the corresponding seat is not engaged.<ul style="list-style-type: none">► Fold the seat backrest back until it engages.
 <p data-bbox="194 512 462 564">Cannot Fold 2nd Seat Row See Operator's Manual</p>	<ul style="list-style-type: none">* The seat backrests on the second row of seats cannot be folded forward.<ul style="list-style-type: none">► Check the requirements for folding forward the seat backrests on the second row of seats (→ page 106).
 <p data-bbox="194 683 462 756">Cannot Fold Forward 2nd Seat Row, Left Adjust Front Seat</p>	<ul style="list-style-type: none">* The left seat backrests on the second row of seats cannot be folded forward.<ul style="list-style-type: none">► Adjust the corresponding front seat.



Display messages	Possible causes/consequences and ► Solutions
 <p data-bbox="144 342 402 417">Cannot Fold Forward 2nd Seat Row, Right Adjust Front Seat</p>	<p data-bbox="473 249 1258 270">* The right seat backrests on the second row of seats cannot be folded forward.</p> <ul data-bbox="495 282 883 308" style="list-style-type: none"><li data-bbox="495 282 883 308">► Adjust the corresponding front seat.
 <p data-bbox="144 539 376 586">3rd Seat Row, Left Not Locked</p>	<p data-bbox="473 446 1264 467">* The left-hand seat or the seat backrest in the third row of seats is not engaged.</p> <ul data-bbox="495 479 1563 536" style="list-style-type: none"><li data-bbox="495 479 1563 505">► Fold the corresponding seat backrest back until it engages and push the row of seats back (→ page 106).<li data-bbox="495 510 1023 536">► Make sure that the seat is engaged (→ page 106).
 <p data-bbox="144 708 389 755">3rd Seat Row, Right Not Locked</p>	<p data-bbox="473 615 1276 636">* The right-hand seat or the seat backrest in the third row of seats is not engaged.</p> <ul data-bbox="495 648 1563 705" style="list-style-type: none"><li data-bbox="495 648 1563 674">► Fold the corresponding seat backrest back until it engages and push the row of seats back (→ page 106).<li data-bbox="495 679 1023 705">► Make sure that the seat is engaged (→ page 106).

Display messages	Possible causes/consequences and ► Solutions
 <p data-bbox="194 336 369 362">Add Washer Fluid</p>	<ul style="list-style-type: none"> <li data-bbox="517 248 1358 274">* The washer fluid level in the washer fluid reservoir has dropped below the minimum. <li data-bbox="545 279 896 305">► Add washer fluid (→ page 377).
<p data-bbox="194 388 471 440">Windshield Wiper Malfunction</p>	<ul style="list-style-type: none"> <li data-bbox="517 388 924 414">* The windshield wiper is malfunctioning. <li data-bbox="545 419 766 445">► Restart the vehicle. <p data-bbox="545 471 896 497">If the display message still appears:</p> <ul style="list-style-type: none"> <li data-bbox="545 502 970 528">► Consult a qualified specialist workshop.

Engine

Display messages	Possible causes/consequences and ► Solutions
<p data-bbox="194 673 471 777">To Switch Off Vehicle Press and Hold Start/Stop Button for at Least 3 Seconds or Press 3 Times</p>	<ul style="list-style-type: none"> <li data-bbox="517 673 1228 699">* You have pressed the start/stop button while the vehicle is in motion. <li data-bbox="545 704 1275 730">► Information about switching off the vehicle while driving (→ page 172).
<p data-bbox="194 802 452 854">Cannot Start Vehicle See Operator's Manual</p>	<ul style="list-style-type: none"> <li data-bbox="517 802 840 828">* The vehicle cannot be started. <li data-bbox="545 833 1007 859">► Switch the vehicle off and switch it back on

Display messages	Possible causes/consequences and ► Solutions
 <p data-bbox="144 381 399 433">Check Coolant Level See Operator's Manual</p>	<ul style="list-style-type: none"> <li data-bbox="495 249 1262 275">► If the display message still appears, consult a qualified specialist workshop. <li data-bbox="476 288 765 313">* The coolant level is too low. <div data-bbox="500 332 1648 417" style="border: 1px solid gray; padding: 5px; margin-top: 5px;"> <p data-bbox="506 339 1027 365">! NOTE Engine damage due to insufficient coolant</p> <p data-bbox="506 381 981 407">► Avoid long journeys with insufficient coolant.</p> </div> <ul style="list-style-type: none"> <li data-bbox="495 433 800 458">► Add coolant (→ page 377). <li data-bbox="495 469 1262 495">► Have the engine cooling system checked at a qualified specialist workshop.
	<ul style="list-style-type: none"> <li data-bbox="476 508 1628 596">* There is a malfunction in the engine cooling system. <ul style="list-style-type: none"> <li data-bbox="495 544 1628 596">► Avoiding high loads on the engine, drive to the nearest qualified specialist workshop. In doing so, ensure that the coolant temperature display remains below the red marking.
 <p data-bbox="144 707 389 759">Coolant Stop Switch Off Vehicle</p>	<ul style="list-style-type: none"> <li data-bbox="476 617 1360 679">* The coolant is too hot. <ul style="list-style-type: none"> <li data-bbox="495 648 1360 679">► Stop immediately in accordance with the traffic conditions and switch off the vehicle. <div data-bbox="500 700 1648 838" style="border: 1px solid gray; padding: 5px; margin-top: 5px;"> <p data-bbox="506 707 1023 733">! WARNING Risk of burns when opening the hood</p> <p data-bbox="506 749 1605 800">If you open the hood in the event of an overheated engine or fire in the engine compartment, the following situations may occur:</p> <ul style="list-style-type: none"> <li data-bbox="519 811 966 837">• You may come into contact with hot gases. </div>

Display messages	Possible causes/consequences and ► Solutions
	<ul style="list-style-type: none"> • You may come into contact with other escaping hot operating fluids. ► Before opening the hood, allow the engine to cool down. ► In the event of a fire in the engine compartment, keep the hood closed and call the fire service. <ul style="list-style-type: none"> ► Wait until the engine has cooled down. ► Make sure that the air supply to the radiator is not obstructed. ► Avoiding high loads on the engine, drive to the nearest qualified specialist workshop. In doing so, ensure that the coolant temperature display remains below the red marking.
 <p data-bbox="195 615 347 636">Fuel Level Low</p>	<ul style="list-style-type: none"> * The fuel supply has dropped into the reserve range. ► Refuel.
 <p data-bbox="195 756 402 777">Fuel Filler Cap Open</p>	<ul style="list-style-type: none"> * The fuel filler cap is not closed correctly or the fuel system is leaking. ► Close the fuel filler cap. ► If the fuel filler cap was already properly closed: consult a qualified specialist workshop.

Transmission





Display messages	Possible causes/consequences and ► Solutions
Shift to P Only When Vehicle Is Stationary	<ul style="list-style-type: none"> * It is possible to select the park position P only if the vehicle is stationary. <ul style="list-style-type: none"> ► Depress the brake pedal. ► Shift the transmission to park position P when the vehicle is stationary.
Depress Brake to Shift from P	<ul style="list-style-type: none"> * You have attempted to shift the transmission out of park position P and into another transmission position. <ul style="list-style-type: none"> ► Depress the brake pedal. ► Select transmission position D, R or neutral N.
To Deselect P or N Depress Brake and Start Vehicle	<ul style="list-style-type: none"> * You have attempted to shift the transmission out of park position P or neutral N and into another transmission position. <ul style="list-style-type: none"> ► Depress the brake pedal. ► Start the vehicle. ► Change the transmission position.
Depress Brake to Shift to D or R	<ul style="list-style-type: none"> * You have attempted to select transmission position D or R. <ul style="list-style-type: none"> ► Depress the brake pedal. ► Select transmission position D or R.
Depress Brake to Shift to R	<ul style="list-style-type: none"> * You have attempted to select transmission position R. <ul style="list-style-type: none"> ► Depress the brake pedal.









Display messages	Possible causes/consequences and ► Solutions
	<ul style="list-style-type: none"> ► Select transmission position R.
Service Required Apply Parking Brake to Park	<ul style="list-style-type: none"> * A malfunction has occurred in the emergency power supply to park position P. ► Consult a qualified specialist workshop. ► Until then, always select park position P manually before you switch off the vehicle. ► Before leaving the vehicle, apply the electric parking brake.
Risk of Vehicle Rolling Away Driver's Door Open Position P Not Selected	<ul style="list-style-type: none"> * The driver's door is not fully closed and transmission position D, R or neutral N is selected. The vehicle may roll away. ► Select park position P when switching off the vehicle.
Risk of Vehicle Rolling Away Apply Parking Brake When Parking	<ul style="list-style-type: none"> * The transmission is malfunctioning. Park position P cannot be selected. ► Park the vehicle safely. ► Use the electric parking brake to secure the vehicle against rolling away. ► On gradients, turn the front wheels so that the vehicle will roll towards the curb if it starts moving.
Reversing Not Possible Service Required	<ul style="list-style-type: none"> * The transmission is malfunctioning. It is not possible to select transmission position R. ► Consult a qualified specialist workshop.
Transmission Malfunction Stop	<ul style="list-style-type: none"> * The transmission is malfunctioning. The transmission shifts to neutral N automatically. ► Stop the vehicle immediately in accordance with the traffic conditions. ► Depress the brake pedal.

Display messages	Possible causes/consequences and ► Solutions
	<ul style="list-style-type: none"> ► Engage park position P. ► Consult a qualified specialist workshop.
Service Required Do Not Change Transmission Position	<ul style="list-style-type: none"> * The transmission is malfunctioning. It is no longer possible to change the transmission position. ► If transmission position D is selected, consult a qualified specialist workshop and do not change the transmission position. ► For all other transmission positions, park the vehicle safely. ► Consult a qualified specialist workshop or breakdown service.
Stop Vehicle Leave Engine Running Wait Transmission Cooling	<ul style="list-style-type: none"> * The transmission is overheating. Pulling away may be temporarily impaired or not possible. ► Stop the vehicle immediately in accordance with the traffic conditions. Do not continue driving. ► Leave the engine running. ► Wait until the display message disappears before pulling away.
Auxiliary Battery Malfunction (white display message)	<ul style="list-style-type: none"> * There is a malfunction in the auxiliary battery. ► Consult a qualified specialist workshop. ► Until then, always select park position P manually before you switch off the vehicle. ► Before leaving the vehicle, apply the electric parking brake.
Auxiliary Battery Malfunction (red display message)	<ul style="list-style-type: none"> * There is a malfunction in the auxiliary battery. ► Consult a qualified specialist workshop. ► Until then, always select park position P manually before you switch off the vehicle.





Display messages	Possible causes/consequences and ► Solutions
	<ul style="list-style-type: none"> ► Before leaving the vehicle, apply the electric parking brake.







Brakes

Display messages	Possible causes/consequences and ► Solutions
<div style="border: 1px solid black; padding: 5px; text-align: center; width: fit-content; margin-bottom: 5px;"> PARK </div> <p>(USA only)</p> <div style="border: 1px solid black; padding: 5px; text-align: center; width: fit-content; margin-bottom: 5px;">  </div> <p>(Canada only)</p> <p>Parking Brake See Operator's Manual</p>	<ul style="list-style-type: none"> * The yellow  indicator lamp is lit. The electric parking brake is malfunctioning. <p>To apply:</p> <ul style="list-style-type: none"> ► Switch the vehicle off and switch it back on. ► Apply the electric parking brake manually (→ page 225). <p>If it is not possible to apply the electric parking brake:</p> <ul style="list-style-type: none"> ► Consult a qualified specialist workshop. ► Where necessary, also secure the parked vehicle against rolling away. * The yellow  indicator lamp and the red  (USA only) or  (Canada only) indicator lamp are lit. The electric parking brake is malfunctioning. <p>To release:</p> <ul style="list-style-type: none"> ► Switch the vehicle off and switch it back on. ► Release the electric parking brake manually (→ page 225). <p>or</p>

Display messages	Possible causes/consequences and ► Solutions
	<ul style="list-style-type: none">► Release the electric parking brake automatically (→ page 225). If it is still not possible to release the electric parking brake:► Do not continue driving. Consult a qualified specialist workshop. <p>* The yellow  indicator lamp is lit and the red  (USA only) or  (Canada only) indicator lamp is flashing. The electric parking brake is malfunctioning.</p> <p>The electric parking brake could not be applied or released.</p> <ul style="list-style-type: none">► Switch the vehicle off and switch it back on. <p>To apply:</p> <ul style="list-style-type: none">► Release and then apply the electric parking brake manually (→ page 225). <p>To release:</p> <ul style="list-style-type: none">► Apply and then release the electric parking brake manually. <p>If the electric parking brake cannot be applied or the red  (USA only) or  (Canada only) indicator lamp continues to flash:</p> <ul style="list-style-type: none">► Do not continue driving. Consult a qualified specialist workshop.► Where necessary, also secure the parked vehicle against rolling away. <p>* The yellow  indicator lamp is lit and the red  (USA only) or  (Canada only) indicator lamp flashes for approximately ten seconds after the electric parking brake has been applied or released. It then remains lit or goes out. The electric parking brake is malfunctioning.</p>

Display messages	Possible causes/consequences and ► Solutions
	<p>If the state of charge is too low:</p> <ul style="list-style-type: none">► Charge the 12 V battery. <p>To apply:</p> <ul style="list-style-type: none">► Switch off the vehicle. The electric parking brake will be applied automatically. <p>If you do not want the electric parking brake to be applied, e.g. at an automatic car wash or when the vehicle is being towed, leave the vehicle switched on. This does not include having the vehicle towed with the rear axle raised.</p> <p>If the electric parking brake is not applied automatically:</p> <ul style="list-style-type: none">► Switch the vehicle off and switch it back on.► Release and then apply the electric parking brake manually (→ page 225). <p>If it is still not possible to apply the electric parking brake:</p> <ul style="list-style-type: none">► Consult a qualified specialist workshop.► Where necessary, also secure the parked vehicle against rolling away. <p>To release:</p> <ul style="list-style-type: none">► If the conditions for automatic release are fulfilled and the electric parking brake is not released automatically, release the electric parking brake manually (→ page 225). <p>If it is still not possible to release the electric parking brake:</p>



Display messages	Possible causes/consequences and ► Solutions
 <p>(USA only)</p>  <p>(Canada only)</p> <p>Release Parking Brake</p>	<ul style="list-style-type: none">► Do not continue driving. Consult a qualified specialist workshop. <p>* The red  indicator lamp (USA only) or  indicator lamp (Canada only) is flashing.</p> <p>The electric parking brake is applied while you are driving:</p> <ul style="list-style-type: none">• A condition for automatic release of the electric parking brake has not been fulfilled (→ page 225).• You are performing emergency braking using the electric parking brake (→ page 225). <ul style="list-style-type: none">► Check the conditions for automatic release of the electric parking brake.► Release the electric parking brake manually.



Display messages	Possible causes/consequences and ► Solutions
<div data-bbox="203 248 360 331"></div> <div data-bbox="203 341 304 367">(USA only)</div> <div data-bbox="203 378 360 461"></div> <div data-bbox="203 471 341 497">(Canada only)</div> <div data-bbox="194 502 462 554">Switch on Vehicle to Release the Parking Brake</div>	<p>* The red  (USA only) or  (Canada only) indicator lamp is lit. You have attempted to release the electric parking brake with the vehicle switched off.</p> <ul style="list-style-type: none"> ► Switch on the vehicle.
<div data-bbox="203 580 360 663"></div> <div data-bbox="194 668 304 694">(USA only)</div> <div data-bbox="203 704 360 787"></div> <div data-bbox="194 797 332 823">(Canada only)</div> <div data-bbox="194 828 443 854">Check Brake Fluid Level</div>	<p>* There is insufficient brake fluid in the brake fluid reservoir.</p> <div data-bbox="554 621 1690 657" style="background-color: #e0e0e0; padding: 5px;"> <p>▲ WARNING Risk of an accident due to low brake fluid level</p> </div> <p>If the brake fluid level is too low, the braking effect and the braking characteristics may be impaired.</p> <ul style="list-style-type: none"> ► Pull over and stop the vehicle safely as soon as possible, paying attention to road and traffic conditions. Do not continue driving under any circumstances. ► Consult a qualified specialist workshop. ► Do not add brake fluid.

504 Display messages and warning/indicator lamps

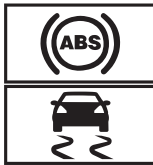

Display messages	Possible causes/consequences and ► Solutions
Check Brake Pads See Operator's Manual	<ul style="list-style-type: none">* The brakepads have reached the wear limit.<ul style="list-style-type: none">► Consult a qualified specialist workshop.

Driving and driving safety systems



Display messages	Possible causes/consequences and ► Solutions
  Currently Unavailable See Operator's Manual	<ul style="list-style-type: none">* ABS and ESP[®] are temporarily unavailable. Other driving systems and driving safety systems (e.g. BAS) may also be temporarily unavailable. The brake system will continue to operate normally. Braking distance may increase in an emergency braking situation. <div style="border: 1px solid black; padding: 5px;"><p>⚠ WARNING Risk of skidding if ABS and ESP[®] are malfunctioning</p><p>The wheels may lock during braking and ESP[®] does not perform any vehicle stabilization. The steerability and braking characteristics are heavily impaired and the braking distance may increase. In addition, other driving safety systems are switched off.</p><ul style="list-style-type: none">► Drive carefully on a suitable stretch of road, making slight steering movements at a speed above 19 mph (30 km/h).► If the display message does not disappear, consult a qualified specialist workshop immediately. Drive carefully.</div>

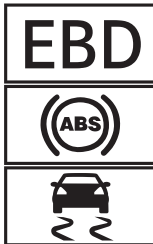



Display messages	Possible causes/consequences and ► Solutions
 <p data-bbox="194 424 471 476">Inoperative See Operator's Manual</p>	<p data-bbox="526 248 1690 347">* ABS and ESP[®] are malfunctioning. Other driving systems and driving safety systems (e.g. BAS) may also be malfunctioning. The brake system will continue to operate normally. Braking distance may increase in an emergency braking situation.</p> <div data-bbox="554 362 1690 404" style="background-color: #f0f0f0; padding: 5px;"> <p data-bbox="563 367 1219 398">▲ WARNING Risk of skidding if ABS and ESP[®] are malfunctioning</p> </div> <p data-bbox="563 409 1690 502">The wheels may block during braking and ESP[®] does not perform any vehicle stabilization. The steerability and braking characteristics are heavily impaired and the braking distance may increase. In addition, other driving safety systems are switched off.</p> <ul data-bbox="563 507 1339 574" style="list-style-type: none"> <li data-bbox="563 507 776 533">► Drive on carefully. <li data-bbox="563 538 1339 574">► Have ABS and ESP[®] checked immediately at a qualified specialist workshop.
 <p data-bbox="194 688 462 740">Currently Unavailable See Operator's Manual</p>	<p data-bbox="526 595 1690 663">* ESP[®] is temporarily unavailable. Other driving systems and driving safety systems (e.g. BAS) may also be malfunctioning.</p> <div data-bbox="554 678 1690 720" style="background-color: #f0f0f0; padding: 5px;"> <p data-bbox="563 683 1118 714">▲ WARNING Risk of skidding if ESP is malfunctioning[®]</p> </div> <p data-bbox="563 725 1690 782">If ESP[®] is malfunctioning, ESP[®] cannot carry out vehicle stabilization. In addition, other driving safety systems are switched off.</p> <ul data-bbox="563 787 1617 844" style="list-style-type: none"> <li data-bbox="563 787 1617 844">► Drive carefully on a suitable stretch of road, making slight steering movements at a speed above 19 mph (30 km/h).

Display messages	Possible causes/consequences and ► Solutions
	<ul style="list-style-type: none"> ► If the display message does not disappear, consult a qualified specialist workshop immediately. Drive carefully.
<div style="text-align: center;">  </div> <p>Inoperative See Operator's Manual</p>	<p>* ESP® is malfunctioning. Other driving systems and driving safety systems (e.g. BAS) may also be malfunctioning. The brake system will continue to operate normally. Braking distance may increase in an emergency braking situation.</p> <div style="background-color: #cccccc; padding: 5px;"> <p>▲ WARNING Risk of skidding if ESP® is malfunctioning</p> </div> <p>If ESP® is malfunctioning, ESP® cannot carry out vehicle stabilization. In addition, other driving safety systems are switched off.</p> <ul style="list-style-type: none"> ► Drive on carefully. ► Have ESP® checked at a qualified specialist workshop.



Display messages	Possible causes/consequences and ► Solutions
 <p data-bbox="194 512 471 564">Inoperative See Operator's Manual</p>	<p data-bbox="526 248 1404 310">* EBD, ABS and ESP® are malfunctioning. Other driving systems and driving safety systems (e.g. BAS) may also be malfunctioning.</p> <div data-bbox="545 326 1690 543" style="border: 1px solid gray; padding: 5px;"> <p data-bbox="554 336 1275 367">▲ WARNING Risk of skidding if EBD, ABS and ESP® are malfunctioning</p> <p data-bbox="563 378 1450 409">The wheels may block during braking and ESP® does not perform any vehicle stabilization.</p> <p data-bbox="563 414 1653 466">The steerability and braking characteristics are heavily impaired and the braking distance may increase. In addition, other driving safety systems are switched off.</p> <ul data-bbox="563 471 1367 533" style="list-style-type: none"> <li data-bbox="563 471 776 502">► Drive on carefully. <li data-bbox="563 507 1367 533">► Have the brake system checked immediately at a qualified specialist workshop. </div>
 <p data-bbox="194 673 231 704">Off</p>	<p data-bbox="526 585 1598 616">* The HOLD function is deactivated because the vehicle is slipping or a condition for activation is not fulfilled.</p> <ul data-bbox="545 621 1635 647" style="list-style-type: none"> <li data-bbox="545 621 1635 647">► Reactivate the HOLD function later or check the activation conditions for the HOLD function (→ page 234).
 <p data-bbox="194 818 471 870">ATTENTION ASSIST: Take a Break!</p>	<p data-bbox="526 725 1561 782">* ATTENTION ASSIST has detected fatigue or an increasing lack of concentration on the part of the driver (→ page 235).</p> <ul data-bbox="545 787 840 813" style="list-style-type: none"> <li data-bbox="545 787 840 813">► If necessary, take a break.



Display messages	Possible causes/consequences and ► Solutions
 <p>--- mph</p>	<ul style="list-style-type: none"> * Cruise control cannot be activated as not all activation conditions are fulfilled. <ul style="list-style-type: none"> ► Observe the activation conditions for cruise control (→ page 238).
Cruise Control Inoperative	<ul style="list-style-type: none"> * Cruise control is malfunctioning. <ul style="list-style-type: none"> ► Consult a qualified specialist workshop.
Cruise Control Off	<ul style="list-style-type: none"> * Cruise control has been deactivated. If there is an additional warning tone, cruise control has been deactivated automatically (→ page 237).
Traffic Sign Assist Currently Unavailable See Operator's Manual	<ul style="list-style-type: none"> * Traffic Sign Assist is temporarily unavailable. Once the cause of the problem is no longer present, the system will be available again. <ul style="list-style-type: none"> ► Continue driving in compliance with traffic regulations.
Traffic Sign Assist Inoperative	<ul style="list-style-type: none"> * Traffic Sign Assist is malfunctioning. <ul style="list-style-type: none"> ► Continue driving in compliance with traffic regulations. or ► Stop the vehicle in accordance with the traffic conditions and restart the vehicle. ► If the display message does not disappear: consult a qualified specialist workshop.

Display messages	Possible causes/consequences and ► Solutions
 <p data-bbox="195 339 458 391">Malfunction Drive at Max. 50 mph</p>	<p data-bbox="524 249 1554 273">* AIRMATIC is functioning only to a limited extent. The vehicle's handling characteristics may be affected.</p> <div data-bbox="547 291 1696 436" style="border: 1px solid gray; padding: 5px;"> <p data-bbox="559 301 1535 325">! NOTE The tires on the front axle or the fenders could be damaged by large steering movements</p> <ul style="list-style-type: none"> <li data-bbox="559 342 1341 366">▶ Avoid large steering movements while driving and listen for scraping sounds. <li data-bbox="559 373 1665 425">▶ If you hear scraping sounds, pull over and stop the vehicle in accordance with the traffic conditions, and set a higher vehicle level if possible. </div> <ul style="list-style-type: none"> <li data-bbox="547 453 1452 477">▶ Drive in a manner appropriate for the current level, but do not exceed 50 mph (80 km/h). <li data-bbox="547 484 966 508">▶ Consult a qualified specialist workshop.
 <p data-bbox="195 622 458 674">Malfunction Drive at Max. 50 mph</p>	<p data-bbox="524 532 1522 556">* E-ACTIVE BODY CONTROL is malfunctioning. The vehicle's handling characteristics may be affected.</p> <div data-bbox="547 573 1696 718" style="border: 1px solid gray; padding: 5px;"> <p data-bbox="559 584 1535 608">! NOTE The tires on the front axle or the fenders could be damaged by large steering movements</p> <ul style="list-style-type: none"> <li data-bbox="559 625 1341 649">▶ Avoid large steering movements while driving and listen for scraping sounds. <li data-bbox="559 656 1665 708">▶ If you hear scraping sounds, pull over and stop the vehicle in accordance with the traffic conditions, and set a higher vehicle level if possible. </div> <ul style="list-style-type: none"> <li data-bbox="547 736 892 760">▶ Max. Speed 50 mph (80 km/h). <li data-bbox="547 767 966 791">▶ Consult a qualified specialist workshop.



Display messages	Possible causes/consequences and ► Solutions
 <p>Lowering</p>	<ul style="list-style-type: none"> * The vehicle level will lower for the following reasons: <ul style="list-style-type: none"> • You have selected a different drive program. • You have exceeded the speed limit. • You have changed the vehicle level by pressing the button. • Operation with a trailer or bicycle rack: if an electrical connection has been correctly made, you have exceeded the speed limit.
 <p>Rising</p>	<ul style="list-style-type: none"> * Your vehicle is adjusting to the level you have selected.
 <p>Vehicle Rising Please Wait</p>	<ul style="list-style-type: none"> * The vehicle level is too low. The vehicle will be raised to the selected vehicle level. <ul style="list-style-type: none"> ► Wait until the display message disappears before pulling away.
 <p>Compressor Is Cooling</p>	<ul style="list-style-type: none"> * Due to frequent level changes within a short space of time, the compressor first needs to cool down in order to set the selected vehicle level. <p>When the compressor has cooled down, the vehicle will continue rising to the selected vehicle level.</p> <ul style="list-style-type: none"> ► Drive on in a manner appropriate for the current level. Make sure that there is sufficient ground clearance.

Display messages	Possible causes/consequences and ► Solutions
 <p data-bbox="195 342 316 363">Slow Down</p>	<p data-bbox="524 249 1058 270">* You are driving too fast for the selected vehicle level.</p> <ul style="list-style-type: none"> <li data-bbox="543 283 1215 304">► Drive more slowly and then select the desired vehicle level again. <p data-bbox="543 335 1585 356">You are driving too quickly with a trailer or the trailer hitch socket is being used, e.g. for a rear bicycle rack.</p> <ul style="list-style-type: none"> <li data-bbox="543 369 925 390">► Read the notes on trailer operation.
<p data-bbox="195 410 473 482">E-ACTIVE BODY CONTROL Function Limited See Operator's Manual</p>	<p data-bbox="524 410 1585 503">* At least one main function of the E-ACTIVE BODY CONTROL system is malfunctioning. The system is outside the operating temperature range or the on-board electrical system voltage is too low. Once the cause of the problem is no longer present, the system will be available again.</p> <div data-bbox="543 519 1696 700" style="border: 1px solid black; padding: 5px;"> <p data-bbox="561 529 1641 581">! NOTE The vehicle's suspension and damping behavior is restricted. The vehicle body may tilt heavily to the side during cornering.</p> <ul style="list-style-type: none"> <li data-bbox="561 596 772 617">► Drive on carefully. <li data-bbox="561 627 1079 648">► Reduce speed considerably before taking a bend. <li data-bbox="561 658 938 679">► Avoid sudden steering movements. </div> <ul style="list-style-type: none"> <li data-bbox="543 715 759 736">► Drive on carefully. <li data-bbox="543 746 1068 767">► Reduce speed considerably before taking a curve. <li data-bbox="543 778 925 798">► Avoid sudden steering movements.
<p data-bbox="195 826 473 878">Selected Level Not Available When Rear Fog Light On</p>	<p data-bbox="524 826 888 847">* You cannot select off-road level +3.</p> <ul style="list-style-type: none"> <li data-bbox="543 860 857 881">► Switch off the rear fog lamp.

Display messages	Possible causes/consequences and ► Solutions
 <p data-bbox="144 339 408 391">Malfunction Drive at Max. 50 mph</p>	<p data-bbox="476 249 1326 308">* At least one main function of the E-ACTIVE BODY CONTROL system is malfunctioning. The system is deactivated.</p> <div data-bbox="500 325 1646 505" style="border: 1px solid gray; padding: 5px;"> <p data-bbox="506 335 1578 387">! NOTE The vehicle's suspension and damping behavior has changed significantly, the vehicle body may tilt heavily to the side during cornering.</p> <ul style="list-style-type: none"> <li data-bbox="506 401 949 425">► Reduce vehicle speed. Drive on carefully. <li data-bbox="506 436 1147 459">► Reduce the vehicle speed considerably before taking a curve. <li data-bbox="506 470 888 494">► Avoid sudden steering movements. </div> <ul style="list-style-type: none"> <li data-bbox="495 522 1160 545">► Continue driving carefully and do not exceed 50 mph (80 km/h). <li data-bbox="495 556 1474 580">► If possible, stop in accordance with the traffic conditions and switch the vehicle off and on again. <li data-bbox="495 590 1264 614">► If the display message still appears, consult a qualified specialist workshop.
 <p data-bbox="144 726 316 750">Malfunction Stop</p>	<p data-bbox="476 632 1430 692">* There is a serious malfunction affecting the hydraulics of the E-ACTIVE BODY CONTROL system. The system is deactivated.</p> <div data-bbox="500 708 1646 819" style="border: 1px solid gray; padding: 5px;"> <p data-bbox="506 718 1227 742">! NOTE The vehicle's driving characteristics have changed significantly.</p> <ul style="list-style-type: none"> <li data-bbox="506 757 1572 809">► Pull over and stop the vehicle safely as soon as possible in accordance with the traffic conditions. Do not continue driving under any circumstances. </div>

Display messages	Possible causes/consequences and ► Solutions
	<ul style="list-style-type: none"> ► Stop the vehicle immediately in accordance with the traffic conditions. Do not continue driving under any circumstances. ► Consult a qualified specialist workshop.
 <p data-bbox="195 443 310 467">Inoperative</p>	<ul style="list-style-type: none"> * The Downhill Speed Regulation is malfunctioning. ► Consult a qualified specialist workshop.
 <p data-bbox="195 583 399 607">Max. Speed 25 mph</p>	<ul style="list-style-type: none"> * The maximum speed of 25 mph (40 km/h) for the Downhill Speed Regulation has been exceeded. ► Drive more slowly.
 <p data-bbox="195 728 430 752">Not in Curr. Drive Prog.</p>	<ul style="list-style-type: none"> * The Downhill Speed Regulation is not available in the currently selected drive program. ► Change the drive program.

Driver assistance systems

Display messages	Possible causes/consequences and ► Solutions
 <p>--- mph</p>	<ul style="list-style-type: none"> * Active Distance Assist DISTRONIC cannot be activated as not all activation conditions are fulfilled. <ul style="list-style-type: none"> ► Comply with the activation conditions of Active Distance Assist DISTRONIC (→ page 241).
 <p>Suspended</p>	<ul style="list-style-type: none"> * If you depress the accelerator pedal beyond the setting of Active Distance Assist DISTRONIC, the system will switch to passive mode (→ page 239).
 <p>Off</p>	<ul style="list-style-type: none"> * Active Distance Assist DISTRONIC was deactivated. If a warning tone also sounds, Active Distance Assist DISTRONIC has deactivated automatically (→ page 241).
<p>Active Distance Assist Currently Unavailable See Operator's Manual</p>	<ul style="list-style-type: none"> * Active Distance Assist DISTRONIC is temporarily unavailable. The ambient conditions are outside the system limits (→ page 239). As soon as the ambient conditions are within the system limits, the system will become available again. <ul style="list-style-type: none"> ► Drive on carefully. or

Display messages	Possible causes/consequences and ► Solutions
	<p>► If the display message does not disappear, stop the vehicle in accordance with the traffic conditions and restart the vehicle.</p>
<p>Active Distance Assist Inoperative</p>	<p>* Active Distance Assist DISTRONIC is malfunctioning. Other driving systems and driving safety systems may also be malfunctioning.</p> <p>► Drive on carefully. or ► Stop the vehicle in accordance with the traffic conditions and restart the vehicle. ► If the display message does not disappear: consult a qualified specialist workshop.</p>
<p>Active Distance Assist Now Available</p>	<p>* Active Distance Assist DISTRONIC is operational again. ► Switch on Active Distance Assist DISTRONIC (→ page 241).</p>
<p>Active Brake Assist Functions Currently Limited See Operator's Manual</p>	<p>* For vehicles with the Driving Assistance Package, the following functions may be temporarily unavailable or only partially available:</p> <ul style="list-style-type: none"> • Active Brake Assist with cross-traffic function • Evasive Steering Assist • PRE-SAFE® PLUS <p>Vehicles with Blind Spot Assist: PRE-SAFE® PLUS is temporarily unavailable. The ambient conditions are outside the system limits (→ page 253).</p> <p>Vehicles without the Driving Assistance Package: Active Brake Assist is temporarily unavailable.</p>

Display messages	Possible causes/consequences and ► Solutions
	<p>► Drive on carefully. As soon as the ambient conditions are within the system limits, the system will become available again.</p> <p>or</p> <p>► If the display message does not disappear, stop the vehicle in accordance with the traffic conditions and restart the vehicle.</p>
<p>Active Brake Assist Functions Limited See Operator's Manual</p>	<p>* For vehicles with the Driving Assistance Package, the following functions may be temporarily unavailable or only partially available:</p> <ul style="list-style-type: none"> • Active Brake Assist with cross-traffic function • Evasive Steering Assist • PRE-SAFE® PLUS <p>Vehicles without the Driving Assistance Package: Active Brake Assist is temporarily unavailable or only partially available.</p> <p>► Drive on carefully.</p> <p>or</p> <p>► Stop the vehicle in accordance with the traffic conditions and restart the vehicle.</p> <p>► If the display message does not disappear: consult a qualified specialist workshop.</p>
<p>Active Steering Assist Currently Unavailable See Operator's Manual</p>	<p>* Active Steering Assist is temporarily unavailable. The ambient conditions are outside the system limits (→ page 248). As soon as the ambient conditions are within the system limits, the system will become available again.</p>





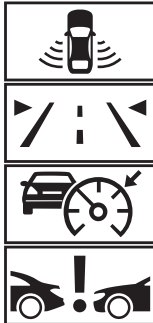

Display messages	Possible causes/consequences and ► Solutions
	<ul style="list-style-type: none"> ► Drive on. ► Check the tire pressure if necessary.
Active Steering Assist Inoperative	<ul style="list-style-type: none"> * Active Steering Assist is malfunctioning. Active Distance Assist DISTRONIC remains available. ► Drive on or ► Stop the vehicle in accordance with the traffic conditions and restart the vehicle. ► If the display message does not disappear: consult a qualified specialist workshop.
Active Steering Assist Currently Unavailable Due to Multiple Emergency Stops	<ul style="list-style-type: none"> * Active Steering Assist is temporarily unavailable due to several emergency stops having been performed. ► Take over the steering and stop in accordance with the traffic conditions. ► Switch the vehicle off and switch it back on. Active Steering Assist is available once more.
 <p>Initiating Emergency Stop</p>	<ul style="list-style-type: none"> * Your hands are not on the steering wheel. Active Steering Assist will initiate an emergency stop (→ page 248). ► Put your hands on the steering wheel. <p>Information on canceling an emergency stop (→ page 250).</p>
Active Stop & Go Assist Currently Unavailable See Operator's Manual	<ul style="list-style-type: none"> * Active Stop-and-Go Assist is temporarily unavailable. Active Distance Assist DISTRONIC and Active Steering Assist are still available. <p>The ambient conditions are outside the system limits (→ page 246).</p>

Display messages	Possible causes/consequences and ► Solutions
	<p>As soon as the ambient conditions are within the system limits, the system will become available again.</p> <ul style="list-style-type: none"> ► Drive on
<p>Active Stop & Go Assist Inoperative See Operator's Manual</p>	<p>* Active Stop-and-Go Assist is malfunctioning.</p> <p>Active Stop-and-Go Assist has been deactivated. Active Distance Assist DISTRONIC and Active Steering Assist are still available.</p> <ul style="list-style-type: none"> ► Drive on or ► Stop the vehicle in accordance with the traffic conditions and restart the vehicle. ► If the display message does not disappear: consult a qualified specialist workshop.
<p>Blind Spot Assist Currently Unavailable See Operator's Manual</p>	<p>* Blind Spot Assist is temporarily unavailable.</p> <p>The system limits have been reached (→ page 260).</p> <p>Once the cause of the problem is no longer present, the system will be available again.</p> <ul style="list-style-type: none"> ► Drive on. or ► If the display message does not disappear, stop the vehicle in accordance with the traffic conditions and restart the vehicle.
<p>Blind Spot Assist Inoperative</p>	<p>* Blind Spot Assist is malfunctioning.</p> <ul style="list-style-type: none"> ► Drive on or

Display messages	Possible causes/consequences and ► Solutions
	<ul style="list-style-type: none"> ► Stop the vehicle in accordance with the traffic conditions and restart the vehicle. ► If the display message does not disappear: consult a qualified specialist workshop.
Blind Spot Assist Not Available When Towing Trailer See Operator's Manual	<p>* When you establish the electrical connection to the trailer, Blind Spot Assist will be unavailable.</p> <ul style="list-style-type: none"> ► Press the left-hand Touch Control and acknowledge the display message.
Active Blind Spot Assist Currently Unavailable See Operator's Manual	<p>* Active Blind Spot Assist is temporarily unavailable. The system limits have been reached (→ page 260). Once the cause of the problem is no longer present, the system will be available again.</p> <ul style="list-style-type: none"> ► Drive on. or ► If the display message does not disappear, stop the vehicle in accordance with the traffic conditions and restart the vehicle.
Active Blind Spot Assist Inoperative	<p>* Active Blind Spot Assist is malfunctioning.</p> <ul style="list-style-type: none"> ► Drive on or ► Stop the vehicle in accordance with the traffic conditions and restart the vehicle. ► If the display message does not disappear: consult a qualified specialist workshop.

Display messages	Possible causes/consequences and ► Solutions
<p>Active Blind Spot Assist Not Available When Towing Trailer See Operator's Manual</p>	<p>* When you establish the electrical connection to the trailer, Active Blind Spot Assist will be unavailable.</p> <ul style="list-style-type: none"> ► Press the left-hand Touch Control and acknowledge the display message.
<p>Active Lane Keeping Assist Currently Unavailable See Operator's Manual</p>	<p>* Active Lane Keeping Assist is temporarily unavailable. The ambient conditions are outside the system limits (→ page 263). As soon as the ambient conditions are within the system limits, the system will become available again.</p> <ul style="list-style-type: none"> ► Drive on.
<p>Active Lane Keeping Assist Inoperative</p>	<p>* Active Lane Keeping Assist is malfunctioning.</p> <ul style="list-style-type: none"> ► Drive on or ► Stop the vehicle in accordance with the traffic conditions and restart the vehicle. ► If the display message does not disappear: consult a qualified specialist workshop.
<p>Active Lane Keeping Assist Limited Range of Functions See Operator's Manual</p>	<p>* Active Lane Keeping Assist is available but restricted.</p> <ul style="list-style-type: none"> ► Drive on or ► Stop the vehicle in accordance with the traffic conditions and restart the vehicle. ► If the display message does not disappear: consult a qualified specialist workshop.

Display messages	Possible causes/consequences and ► Solutions
 <p data-bbox="194 595 443 647">Temporarily Unavailable Sensors Dirty</p>	<p data-bbox="526 248 1450 274">* Front and corner radar sensors (hereafter "sensors") are malfunctioning. Possible causes are:</p> <ul data-bbox="545 284 1201 378" style="list-style-type: none"> • The sensors are dirty • Heavy rain or snow • Extended country driving without other traffic, e.g. in the desert <p data-bbox="545 393 1690 445">Driving systems and driving safety systems may be malfunctioning or temporarily unavailable. The brake system, steering and drive system will continue to function normally.</p> <p data-bbox="545 455 757 481">► Drive on carefully.</p> <p data-bbox="545 502 1690 554">Once the causes of the problem are no longer present, the driving systems and driving safety systems will be available again and the corresponding symbols will be switched off.</p> <p data-bbox="545 564 960 590">If the display message does not disappear:</p> <ul data-bbox="545 600 1145 694" style="list-style-type: none"> ► Stop the vehicle in accordance with the traffic conditions. ► Clean all sensor covers from outside (→ page 228). ► Restart the vehicle.

Display messages	Possible causes/consequences and ► Solutions
	<p>* The view of the multifunction camera is restricted. Possible causes are:</p> <ul style="list-style-type: none"> • Dirt on the windshield in the field of vision of the multifunction camera • Heavy rain, snow or fog • Mist on the inside of the windshield: in certain weather conditions, mist can form on the inside of the windshield during cold times of year in particular. <p> This mist on the windshield will be removed automatically within a short time with the aid of a heater. The restriction is temporary.</p> <p>Driving systems and driving safety systems may be malfunctioning or temporarily unavailable. The brake system, steering and drive system will continue to function normally.</p> <p> Drive on carefully.</p> <p>Once the causes of the problem are no longer present, the driving systems and driving safety systems will be available again and the corresponding symbols will be switched off.</p> <p>If the display message does not disappear:</p> <ul style="list-style-type: none">  Stop the vehicle in accordance with the traffic conditions.  Clean the windshield, especially in the position of the multifunction camera (→ page 228).  Restart the vehicle.
<p>Camera View Reduced See Operator's Manual</p>	

Display messages	Possible causes/consequences and ► Solutions
 <p data-bbox="194 512 443 564">Functions Limited When Towing Trailer</p>	<ul style="list-style-type: none"> * When the trailer socket is occupied, some driving systems will be available only to a limited extent. <ul style="list-style-type: none"> ► Drive carefully if you are towing a trailer or have the bicycle rack mounted.
<p data-bbox="194 585 462 637">PRE-SAFE Inoperative See Operator's Manual</p>	<ul style="list-style-type: none"> * The PRE-SAFE® functions are malfunctioning. <ul style="list-style-type: none"> ► Consult a qualified specialist workshop.
<p data-bbox="194 663 462 740">PRE-SAFE Pulse Side Inoperative See Operator's Manual</p>	<ul style="list-style-type: none"> * The PRE-SAFE® Impulse Side system is malfunctioning or inoperative after having already been triggered. <ul style="list-style-type: none"> ► Consult a qualified specialist workshop.

Parking assistance systems



Display messages	Possible causes/consequences and ► Solutions
<p>PARKTRONIC Inoperative See Operator's Manual</p>	<p>* Parking Assist PARKTRONIC is malfunctioning. Once the cause of the problem is no longer present, the system will be available again.</p> <ul style="list-style-type: none">► Continue driving while paying attention to the vehicle's surroundings. <p>or</p> <ul style="list-style-type: none">► Stop the vehicle in accordance with the traffic conditions and restart the vehicle.► If the display message still appears, consult a qualified specialist workshop.
<p>Active Parking Assist and PARKTRONIC Inoperative See Operator's Manual</p>	<p>* Active Parking Assist and Parking Assist PARKTRONIC are malfunctioning. Once the cause of the problem is no longer present, the system will be available again.</p> <ul style="list-style-type: none">► Continue driving while paying attention to the vehicle's surroundings. <p>or</p> <ul style="list-style-type: none">► Stop the vehicle in accordance with the traffic conditions and restart the vehicle.► If the display message still appears, consult a qualified specialist workshop.

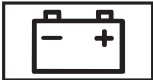

Mercedes-Benz emergency call system

Display messages	Possible causes/consequences and ► Solutions
 <p data-bbox="195 381 310 405">Inoperative</p>	<p data-bbox="524 288 1681 339">* The Mercedes-Benz emergency call system is malfunctioning. The Mercedes me connect system is also malfunctioning.</p> <ul style="list-style-type: none"> <li data-bbox="543 350 962 373">► Consult a qualified specialist workshop.

Battery

Display messages	Possible causes/consequences and ► Solutions
 <p data-bbox="195 647 449 699">12 V On-board Electrical System Service Required</p>	<p data-bbox="524 554 1073 578">* The 12 V on-board electrical system is malfunctioning.</p> <ul style="list-style-type: none"> <li data-bbox="543 588 1086 612">► Consult a qualified specialist workshop immediately.
 <p data-bbox="195 816 443 868">Stop Vehicle See Operator's Manual</p>	<p data-bbox="524 723 1350 746">* The 12 V battery is no longer being charged and the condition of charge is too low.</p> <div data-bbox="550 767 1696 850" style="border: 1px solid gray; padding: 5px;"> <p data-bbox="559 772 1123 798">! NOTE Possible engine damage if you continue driving</p> <ul style="list-style-type: none"> <li data-bbox="559 814 1082 838">► Do not continue driving under any circumstances. </div>



Display messages	Possible causes/consequences and ► Solutions
	<p data-bbox="513 256 1646 291">► Consult a qualified specialist workshop.</p> <ul style="list-style-type: none"> <li data-bbox="513 308 1633 360">► Stop the vehicle immediately in accordance with the traffic conditions. Do not continue driving under any circumstances. <li data-bbox="513 370 746 394">► Switch off the vehicle. <li data-bbox="513 405 912 428">► Consult a qualified specialist workshop.
 <p data-bbox="144 539 386 588">Switch on vehicle to charge the 12 V battery</p>	<p data-bbox="473 446 1227 470">* The vehicle is off and the condition of charge of the 12 V battery is too low.</p> <ul style="list-style-type: none"> <li data-bbox="513 480 1049 504">► Switch off electrical consumers that are not required. <li data-bbox="513 508 741 532">► Drive for 30–60 mins. <p data-bbox="513 542 519 566">or</p> <ul style="list-style-type: none"> <li data-bbox="513 577 1079 600">► Charge the 12 V battery when stationary (→ page 402). <li data-bbox="513 611 1212 635">► Plug-in hybrid: Charge the vehicle at a charging station (→ page 204).
 <p data-bbox="144 743 421 819">Stop Vehicle To Charge the 12 V Battery Do Not Switch Off Vehicle</p>	<p data-bbox="473 650 883 674">* The 12 V battery charge level is too low.</p> <ul style="list-style-type: none"> <li data-bbox="513 684 1633 736">► Stop the vehicle immediately in accordance with the traffic conditions. Do not continue driving under any circumstances. <li data-bbox="513 746 778 770">► Leave the vehicle running <li data-bbox="513 781 957 804">► If the display message disappears: drive on. <li data-bbox="513 815 1332 839">► If the display message does not disappear: consult a qualified specialist workshop.

Display messages	Possible causes/consequences and ► Solutions
 <p data-bbox="194 341 452 419">Battery Overheated Stop! Everyone Get Out! Out- doors if Possible</p>	<ul style="list-style-type: none"> * The 48 V battery is overheating. There is a risk of fire. <ul style="list-style-type: none"> ► Stop the vehicle immediately in accordance with the traffic conditions. ► If possible, stop the vehicle in the open air and ensure that all vehicle occupants get out. ⓘ Supporting vehicle functions may activate automatically, e.g. air-recirculation mode as part of climate control. ► Do not continue driving. ► If smoke is present, leave the danger zone and call the fire service immediately. ► Consult a qualified specialist workshop even if there are no external signs of a fire.
 <p data-bbox="194 595 443 647">48 V Battery See Opera- tor's Manual</p>	<ul style="list-style-type: none"> * The 48 V on-board electrical system has function restrictions. Comfort functions, such as the climate control system, may be restricted. It is possible to continue driving. <ul style="list-style-type: none"> ► If the display message remains active continuously, consult a qualified specialist workshop immediately.
 <p data-bbox="194 761 462 813">Please Wait Charging 48 V Battery...</p>	<ul style="list-style-type: none"> * The 48 V battery is discharged. You have switched on the vehicle while the 12 V battery was being charged with a suitable charger or while another vehicle was providing starting assistance. The discharged 48 V battery is charged automatically via the voltage converter. After a few minutes, the Starting Possible Again display message will be shown on the driver's display. <ul style="list-style-type: none"> ► Start the vehicle.



Display messages	Possible causes/consequences and ► Solutions
	<ul style="list-style-type: none"> ► Drive the vehicle for a while to charge the 12 V battery and the 48 V battery after disconnecting the charger from the vehicle. <p>If the Starting Possible Again display message does not appear after a few minutes:</p> <ul style="list-style-type: none"> ► Try to start the vehicle. ► If the vehicle does not start, consult a qualified specialist workshop.
Cannot Start Vehicle See Operator's Manual	<p>* The state of charge of the 48 V battery is too low. You can no longer start the vehicle.</p> <ul style="list-style-type: none"> ► Switch off electrical consumers that are not required. ► Connect a suitable charger approved for Mercedes-Benz with sufficient charge output to the jump-start connection point of the 12 V battery (→ page 402). The 48 V battery is charged via the voltage converter in the vehicle.
Starting Possible Again	<p>* The 48 V battery has been charged automatically via the voltage converter.</p> <ul style="list-style-type: none"> ► Start the vehicle and drive for a while to charge the 12 V battery and the 48 V battery.

Tire pressure monitor

Display messages	Possible causes/consequences and ► Solutions
Tire Pressure Monitor Currently Unavailable	<p>* There is interference from a powerful radio signal source. As a result, no signals from the tire pressure sensor are being received. The tire pressure monitoring system is temporarily unavailable. The tire pressure monitoring system will restart automatically as soon as the cause has been rectified.</p>

Display messages	Possible causes/consequences and ► Solutions
<p>Tire Pressure Monitor Inoperative</p>	<p>► Drive on.</p> <p>* The tire pressure monitoring system is malfunctioning.</p> <div data-bbox="550 332 1696 482" style="border: 1px solid gray; padding: 5px;"> <p>⚠ WARNING There is a risk of an accident if the tire pressure monitoring system is malfunctioning</p> <p>The tire pressure monitoring system cannot issue a warning if there is pressure loss in one or more of the tires. Tires with insufficient tire pressure may impair the driving characteristics as well as steering and braking.</p> <p>► Have the tire pressure monitoring system checked at a qualified specialist workshop.</p> </div>
<p>Tire Pressure Monitor Inoperative Tire Pressure Sensors Missing</p>	<p>* The wheels installed do not have suitable tire pressure sensors. The tire pressure monitoring system is deactivated.</p> <p>► Install wheels with suitable tire pressure sensors.</p>
<p> Wheel Sensor(s) Missing</p>	<p>* There is no signal from the tire pressure sensor in at least one wheel. No pressure value is displayed for the affected tire.</p> <p>► Have the faulty tire pressure sensor replaced at a qualified specialist workshop.</p>
<p> Check Tires</p>	<p>* The tire pressure in one or more tires has dropped significantly. The wheel position is displayed. A warning tone will also sound.</p>

Display messages	Possible causes/consequences and ► Solutions
	<p>▲ WARNING Risk of an accident due to insufficient tire pressure</p> <ul style="list-style-type: none">• The tires can burst.• The tires can wear excessively and/or unevenly.• The driving characteristics as well as the steering and braking may be greatly impaired. <p>You could then lose control of the vehicle.</p> <ul style="list-style-type: none">► Observe the recommended tire pressures.► Adjust the tire pressure if necessary. <p>► Stop the vehicle in accordance with the traffic conditions.</p> <p>► Check the tire pressure (→ page 415) and the tires.</p>
 <p>Please Correct Tire Pressure</p>	<p>* The tire pressure is too low in at least one of the tires, or the difference in tire pressure between the individual wheels is too great.</p> <ul style="list-style-type: none">► Check the tire pressure and add air, if necessary.► When the tire pressure is correct, restart the tire pressure monitor (→ page 420).

Display messages	Possible causes/consequences and ► Solutions
 <p data-bbox="199 341 452 367">Warning Tire Malfunction</p>	<p data-bbox="526 248 1413 274">* The pressure in one or more tires has dropped suddenly. The wheel position is displayed.</p> <div data-bbox="545 290 1690 580"><p data-bbox="554 300 1164 326">▲ WARNING Risk of an accident from driving with a flat tire</p><ul data-bbox="563 336 1598 398" style="list-style-type: none">• The tires can overheat and be damaged.• The driving characteristics as well as the steering and braking characteristics may be greatly impaired.<p data-bbox="563 414 970 440">You could then lose control of the vehicle.</p><ul data-bbox="563 450 1653 569" style="list-style-type: none">► Do not drive with a flat tire.► Do not exceed the maximum permissible driving distance in emergency mode and the maximum permissible speed with a flat MOExtended tire.► Observe the notes on flat tires.</div> <p data-bbox="545 595 877 621">Notes on flat tires (→ page 390).</p> <ul data-bbox="545 631 1145 688" style="list-style-type: none">► Stop the vehicle in accordance with the traffic conditions.► Check the tires.
 <p data-bbox="199 797 369 823">Tires Overheated</p>	<p data-bbox="526 709 1663 761">* At least one tire is overheating. The affected tires are displayed in red. At temperatures close to the limit value, the tires are displayed in yellow.</p> <div data-bbox="545 777 1690 844"><p data-bbox="554 787 1228 813">▲ WARNING Risk of an accident from driving with overheated tires</p><p data-bbox="563 823 831 849">Overheated tires can burst.</p></div>

532 Display messages and warning/indicator lamps



Display messages	Possible causes/consequences and ► Solutions
	<p>► Reduce speed so that the tires cool down.</p>
 <p>Reduce Speed</p>	<p>* At least one tire is overheating. The affected tires are displayed in red. At temperatures close to the limit value, the tires are displayed in yellow.</p> <p>▲ WARNING Risk of an accident from driving with overheated tires</p> <p>Overheated tires can burst.</p> <p>► Reduce speed so that the tires cool down.</p>

Tire pressure loss warning system

Display messages	Possible causes/consequences and ► Solutions
<p>Check Tire and Tire Pressure</p>	<p>* Canada only: The tire pressure loss warning system has detected a significant loss of pressure.</p> <p>▲ WARNING Risk of an accident due to insufficient tire pressure</p> <ul style="list-style-type: none">• The tires can burst.• The tires can wear excessively and/or unevenly.• The driving characteristics as well as the steering and braking may be greatly impaired.

Display messages	Possible causes/consequences and ► Solutions
	<p>You could then lose control of the vehicle.</p> <ul style="list-style-type: none"> ► Observe the recommended tire pressures. ► Adjust the tire pressure if necessary. <ul style="list-style-type: none"> ► Stop the vehicle in accordance with the traffic conditions. ► Check the tire pressure (→ page 415) and the tires. ► When the tire pressure is correct, restart the tire pressure loss warning system (→ page 421).
<p>Check Tire Pressure Then Restart Run Flat Indicator</p>	<p>* Canada only: The tire pressure loss warning system generated a display message and has not been restarted since.</p> <ul style="list-style-type: none"> ► When the tire pressure is correct, restart the tire pressure loss warning system (→ page 421).
<p>Tire Pressure Monitor Inoperative</p>	<p>* Canada only: The tire pressure loss warning system is malfunctioning.</p> <ul style="list-style-type: none"> ► Consult a qualified specialist workshop.

Engine oil

Display messages	Possible causes/consequences and ► Solutions
 <p data-bbox="144 381 408 456">Check Engine Oil Level At Next Refueling (Add 1 Quart)</p>	<p data-bbox="476 288 1023 311">* The engine oil level has dropped to the minimum level.</p> <div data-bbox="500 332 1646 370" style="border: 1px solid gray; padding: 2px;"> <p data-bbox="506 339 1197 363">! NOTE Engine damage caused by driving with insufficient engine oil</p> </div> <div data-bbox="500 373 1646 412" style="border: 1px solid gray; padding: 2px;"> <p data-bbox="506 381 999 405">► Avoid long journeys with insufficient engine oil.</p> </div> <p data-bbox="495 433 1190 456">► When next refueling, add 1.1 US qt (1 l) of engine oil (→ page 375).</p> <p data-bbox="495 474 833 498">Notes on engine oil (→ page 455).</p>
 <p data-bbox="144 612 421 660">Engine Oil Level Reduce Oil Level</p>	<p data-bbox="476 519 790 542">* The engine oil level is too high.</p> <div data-bbox="500 563 1646 601" style="border: 1px solid gray; padding: 2px;"> <p data-bbox="506 570 1160 594">! NOTE Engine damage caused by driving with excess engine oil</p> </div> <div data-bbox="500 605 1646 643" style="border: 1px solid gray; padding: 2px;"> <p data-bbox="506 612 962 636">► Avoid long journeys with excess engine oil.</p> </div> <p data-bbox="495 664 1400 687">► Consult a qualified specialist workshop immediately and have the engine oil level reduced.</p>
 <p data-bbox="144 795 358 844">Engine Oil Level Stop Switch Off Vehicle</p>	<p data-bbox="476 702 783 726">* The engine oil level is too low.</p> <div data-bbox="500 746 1646 785" style="border: 1px solid gray; padding: 2px;"> <p data-bbox="506 754 1197 778">! NOTE Engine damage caused by driving with insufficient engine oil</p> </div> <div data-bbox="500 788 1646 826" style="border: 1px solid gray; padding: 2px;"> <p data-bbox="506 795 999 819">► Avoid long journeys with insufficient engine oil.</p> </div>

Display messages	Possible causes/consequences and ► Solutions
	<ul style="list-style-type: none"> ► Stop the vehicle immediately in accordance with the traffic conditions. Do not continue driving under any circumstances. ► Switch off the vehicle. ► Add 1.1 US qt (1 l) of engine oil (→ page 375). ► Check the engine oil level. <p>Notes on engine oil (→ page 455).</p>
<div style="border: 1px solid black; width: 40px; height: 40px; margin: 0 auto; display: flex; align-items: center; justify-content: center;">  </div> <p>Engine Oil Pressure Stop Switch Off Vehicle</p>	<p>* The oil pressure is too low.</p> <div style="border: 1px solid gray; padding: 5px; margin: 5px 0;"> <p>! NOTE Engine damage caused by driving with insufficient oil pressure</p> <ul style="list-style-type: none"> ► Avoid driving with insufficient oil pressure. </div> <ul style="list-style-type: none"> ► Stop the vehicle immediately in accordance with the traffic conditions. Do not continue driving under any circumstances. ► Switch off the vehicle. ► Consult a qualified specialist workshop.

Display messages	Possible causes/consequences and ► Solutions
 <p data-bbox="144 339 417 389">Engine Oil Level Cannot Be Measured</p>	<p data-bbox="473 249 1461 273">* The electrical connection to the oil level sensor has been interrupted or the oil level sensor is faulty.</p> <p data-bbox="491 283 916 307">► Consult a qualified specialist workshop.</p>

Warning and indicator lamps

Overview of indicator and warning lamps

Some systems will perform a self-test when the vehicle is switched on. Some indicator and warning lamps may briefly light up or flash. This behavior is non-critical. These indicator and warning lamps indicate a malfunction only if they light up or flash after the vehicle has been started or during a journey.

Driver's display

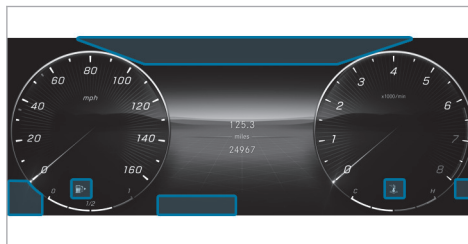

Indicator and warning lamps

Occupant safety

 Seat belt (→ page 538)

 Seat belt (→ page 538)

Drive system

 Reduced power (→ page 539)

 System error (→ page 539)

 Electrical malfunction (→ page 539)

Vehicle



 Power steering (yellow) (→ page 540)

 Power steering (red) (→ page 540)





Engine

 Coolant temperature (→ page 541)



 Engine diagnosis (→ page 541)







-  Engine operating temperature
(→ page 541)
-  Electrical malfunction (→ page 541)
-  Reserve fuel with fuel filler flap location
indicator (→ page 541)

Braking

-  Electric parking brake (yellow)
(→ page 545)
- PARK** USA: electric parking brake (red)
(→ page 545)
-  Canada: electric parking brake (red)
(→ page 545)
- RBS** USA: Recuperative Brake System
(→ page 545)
-  Canada: brakes (yellow)(→ page 545)
- BRAKE** USA: brakes (red) (→ page 545)
-  Canada: brakes (red) (→ page 545)

Driving and driving safety systems

-  ABS (→ page 548)
-  ESP® (→ page 548)

-  ESP® OFF (→ page 548)
-  ATTENTION ASSIST (→ page 548)
-  Distance warning (→ page 548)
-  Active Brake Assist (→ page 548)
-  Active Brake Assist (→ page 548)
-  AIRMATIC/E-ACTIVE BODY CONTROL
(→ page 548)





Mercedes-Benz emergency call system

-  Mercedes-Benz emergency call system
(→ page 552)



Tire pressure monitoring system

-  Tire pressure monitoring system
(→ page 552)

Exterior lighting



-  Standing lights (→ page 141)
-  Low beam (→ page 141)
-  High beam (→ page 142)
-  Turn signal lights (→ page 142)
-  Rear fog light (→ page 141)

Symbols on the central display

-  Drive Away Assist (→ page 295)
-  Rear cross traffic warning (→ page 296)
-  Maneuvering brake function (→ page 296)

Occupant safety



Warning/indicator lamp	Possible causes/consequences and ► Solutions
 <p data-bbox="144 381 395 433">Restraint system warning lamp</p>	<p data-bbox="462 288 1123 339">* The restraint system red warning lamp is lit while the vehicle is on. The restraint system is malfunctioning (→ page 47).</p> <div data-bbox="482 360 1644 474" style="border: 1px solid gray; padding: 5px;"> <p data-bbox="491 365 1193 391">▲ WARNING Risk of injury due to malfunctions in the restraint system</p> <p data-bbox="491 407 1559 433">Components in the restraint system may be activated unintentionally or not deploy as planned in an accident.</p> <p data-bbox="491 438 1456 464">► Have the restraint system checked and repaired immediately at a qualified specialist workshop.</p> </div> <p data-bbox="476 490 617 515">Plug-in hybrid:</p> <div data-bbox="482 536 1644 774" style="border: 1px solid gray; padding: 5px;"> <p data-bbox="491 541 1175 567">▲ DANGER Risk of death due to the restraint system malfunctioning</p> <p data-bbox="491 583 1629 635">Components in the restraint system may be activated unintentionally or not deploy as intended in an accident. In the event of an accident, the high-voltage on-board electrical system may not be deactivated as intended.</p> <p data-bbox="491 645 1581 697">You may receive an electric shock if you touch the damaged components of the high-voltage on-board electrical system.</p> <p data-bbox="491 707 1456 733">► Have the restraint system checked and repaired immediately at a qualified specialist workshop.</p> <p data-bbox="491 738 1045 764">► After an accident, switch off the vehicle immediately.</p> </div> <ul data-bbox="476 790 1020 885" style="list-style-type: none"> <li data-bbox="476 790 687 816">► Drive on carefully. <li data-bbox="476 821 925 847">► Note the messages on the driver's display. <li data-bbox="476 852 1020 885">► Consult a qualified specialist workshop immediately.

Warning/indicator lamp	Possible causes/consequences and ► Solutions
 <p data-bbox="194 341 425 388">Seat belt warning lamp flashes</p>	<p data-bbox="508 248 1441 300">* The red seat belt warning lamp flashes and an intermittent warning tone sounds. The driver or front passenger has not fastened his/her seat belt while the vehicle is in motion.</p> <ul style="list-style-type: none"> <li data-bbox="526 310 905 336">► Fasten your seat belt (→ page 47). <li data-bbox="526 336 979 362">There are objects on the front passenger seat. <li data-bbox="526 367 1062 393">► Remove the objects from the front passenger seat.
 <p data-bbox="194 502 425 549">Seat belt warning lamp lights up</p>	<p data-bbox="508 409 1358 435">* The red seat belt warning lamp lights up for six seconds once the vehicle has started.</p> <p data-bbox="526 445 1459 497">In addition, an intermittent warning tone may sound. The red seat belt warning lamp reminds the driver and front passenger to fasten their seat belts.</p> <ul style="list-style-type: none"> <li data-bbox="526 502 905 528">► Fasten your seat belt (→ page 47). <p data-bbox="526 549 1515 574">If you have placed objects on the front passenger seat, the red seat belt warning lamp may remain lit.</p>

Hybrid system

Warning/indicator lamp	Possible causes/consequences and ► Solutions
 <p data-bbox="194 808 425 854">Reduced warning lamp power</p>	<p data-bbox="508 714 979 766">* The yellow reduced-power warning lamp is on. Drive system power output is reduced.</p> <ul style="list-style-type: none"> <li data-bbox="526 771 979 797">► Note the messages on the driver's display.

540 Display messages and warning/indicator lamps

Warning/indicator lamp	Possible causes/consequences and ► Solutions
 <p data-bbox="144 342 426 391">System malfunction warning lamp</p>	<p data-bbox="463 249 1452 298">* The red system error warning lamp is lit while the vehicle is in a state of operational readiness READY. There is a malfunction in the drive system.</p> <p data-bbox="476 311 925 335">► Note the messages on the driver's display.</p>
 <p data-bbox="144 501 421 550">Electrical malfunction warning lamp</p>	<p data-bbox="463 408 957 456">* The red electrical malfunction warning lamp is lit. There is a malfunction with the electrics.</p> <p data-bbox="476 470 925 494">► Note the messages on the driver's display.</p>

Vehicle

Warning/indicator lamp	Possible causes/consequences and ► Solutions
 <p data-bbox="144 787 376 836">Power steering warning lamp (yellow)</p>	<p data-bbox="463 694 1188 742">* The yellow power steering warning lamp is lit while the vehicle is running. The power assistance or the steering itself is malfunctioning.</p> <p data-bbox="476 756 925 780">► Note the messages on the driver's display.</p>

Warning/indicator lamp	Possible causes/consequences and ► Solutions
 <p data-bbox="194 341 425 393">Power steering warning lamp (red)</p>	<p data-bbox="508 248 1210 300">* The red power steering warning lamp is lit while the vehicle is running. The power assistance or the steering itself is malfunctioning.</p> <div data-bbox="526 315 1690 497" style="border: 1px solid gray; padding: 5px;"><p data-bbox="535 326 1164 352">▲ WARNING Risk of accident if steering capability is impaired</p><p data-bbox="545 362 1422 388">If the steering does not function as intended, the vehicle's operating safety is jeopardized.</p><ul data-bbox="545 398 1663 486" style="list-style-type: none"><li data-bbox="545 398 1663 450">▶ Pull over and stop the vehicle safely as soon as possible, paying attention to road and traffic conditions. Do not continue driving under any circumstances.<li data-bbox="545 455 960 486">▶ Consult a qualified specialist workshop.</div> <p data-bbox="526 512 979 538">► Note the messages on the driver's display.</p>

Engine

Warning/indicator lamp	Possible causes/consequences and ► Solutions
 <p data-bbox="194 771 452 823">Engine operating temperature warning lamp</p>	<p data-bbox="508 678 1275 730">* After a cold start, the blue engine operating temperature warning lamp is on. Engine output and engine torque are reduced.</p> <p data-bbox="526 740 1034 766">► Take this into consideration in your driving style.</p>

Warning/indicator lamp



Coolant warning lamp (red)

Possible causes/consequences and ► Solutions

* The red coolant warning lamp is lit while the engine is running.

Possible causes are:

- The temperature sensor is malfunctioning
- The coolant level is too low
- The air supply to the radiator is obstructed
- The radiator fan is faulty
- The engine coolant pump is faulty

If there is an additional warning tone, the coolant temperature has exceeded the maximum permissible temperature.



▲ WARNING Risk of burns when opening the hood



If you open the hood in the event of an overheated engine or fire in the engine compartment, the following situations may occur:

- You may come into contact with hot gases.
- You may come into contact with other escaping hot operating fluids.



- Before opening the hood, allow the engine to cool down.
- In the event of a fire in the engine compartment, keep the hood closed and call the fire service.

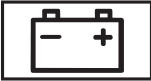



- Stop immediately in accordance with the traffic conditions and switch off the vehicle. Do not continue driving.
- Note the messages on the driver's display.

Warning/indicator lamp	Possible causes/consequences and ► Solutions
	<p>If the coolant temperature display is at the lower end of the temperature scale:</p> <ul style="list-style-type: none"> ► Consult a qualified specialist workshop. <p>If the coolant temperature display is at the upper end of the temperature scale:</p> <ul style="list-style-type: none"> ► Exit the vehicle and keep a safe distance from it until the engine has cooled down. ► Check the coolant level (→ page 377). ► Make sure that the air supply to the radiator is not obstructed. ► Avoiding high loads on the engine, drive to the nearest qualified specialist workshop. In doing so, ensure that the coolant temperature display remains below the red area.
 <p>Coolant warning lamp (yellow)</p>	<p>* The yellow coolant warning lamp is lit while the engine is running.</p> <p>Possible causes are:</p> <ul style="list-style-type: none"> • The temperature sensor is malfunctioning • The charge air, transmission oil or battery cooling is faulty • The radiator shutters are blocked or defective <ul style="list-style-type: none"> ► Avoiding high loads on the engine, drive to the nearest qualified specialist workshop.
 <p>Check Engine warning lamp</p>	<p>* The yellow Check Engine warning lamp is lit while the engine is running. A malfunction has occurred in the engine, the exhaust system or the fuel system. The emissions limit value may have been exceeded and the engine may be running in emergency operation mode.</p>

Warning/indicator lamp	Possible causes/consequences and ► Solutions
	<p>In some states, legal requirements stipulate that you must immediately consult a qualified specialist workshop as soon as the yellow Check Engine warning lamp lights up.</p> <ul style="list-style-type: none">► Have the vehicle checked as soon as possible at a qualified specialist workshop.
 <p>Electrical malfunction warning lamp</p>	<p>* The red electrical malfunction warning lamp is lit. There is a malfunction in the electrics.</p> <ul style="list-style-type: none">► Note the messages on the driver's display.
 <p>Fuel reserve warning lamp flashes</p>	<p>* The yellow fuel reserve warning lamp lights up while you are driving. There has been pressure loss in the fuel system. The fuel filler cap is not closed correctly or the fuel system is leaking.</p> <ul style="list-style-type: none">► Close the fuel filler cap. <p>If the fuel filler cap has already been closed correctly:</p> <ul style="list-style-type: none">► Consult a qualified specialist workshop.
 <p>Fuel reserve warning lamp lights up</p>	<p>* The yellow fuel reserve warning lamp lights up while the engine is running. The fuel supply has dropped into the reserve range.</p> <ul style="list-style-type: none">► Refuel.



Brakes



Warning/indicator lamp	Possible causes/consequences and ► Solutions
 <p>Electric parking brake indicator lamp (red) (USA only)</p>  <p>Electric parking brake indicator lamp (red) (Canada only)</p>  <p>Electric parking brake indicator lamp (yellow)</p>	<p>* The red electric parking brake indicator lamp flashes or is lit. The yellow electric parking brake indicator lamp is also lit in the event of a malfunction.</p> <ul style="list-style-type: none">► Note the messages on the driver's display.



Warning/indicator lamp	Possible causes/consequences and ► Solutions
 <p>RBS warning lamp (USA only)</p>  <p>Brakes warning lamp (yellow) (Canada only)</p>	<p>*The yellow  warning lamp (USA only) or the yellow  brake warning lamp (Canada only) is lit while the vehicle is running.</p> <p>▲ WARNING Risk of an accident due to a brake system malfunction</p> <p>If the brake system is malfunctioning, braking characteristics may be impaired.</p> <ul style="list-style-type: none">▶ Drive on carefully.▶ Have the brake system checked immediately at a qualified specialist workshop. <p>► Adjust your speed and drive on carefully, leaving a suitable distance to the vehicle in front.</p> <p>► If the driver's display shows a display message, observe it.</p> <p>► Consult a qualified specialist workshop.</p>





Warning/indicator lamp	Possible causes/consequences and ► Solutions
<div data-bbox="203 248 360 331" data-label="Image"> </div> <p data-bbox="194 341 462 388">Brakes warning lamp (USA only)</p> <div data-bbox="203 393 360 476" data-label="Image"> </div> <p data-bbox="194 486 462 533">Brakes warning lamp (Canada only)</p>	<p data-bbox="508 248 1118 274">* The red brake warning lamp is lit while the vehicle is running.</p> <p data-bbox="526 284 729 305">Possible causes are:</p> <ul data-bbox="526 315 1450 378" style="list-style-type: none"> • The brake force boosting is malfunctioning and the braking characteristics may be affected. • There is insufficient brake fluid in the brake fluid reservoir. <p data-bbox="526 393 970 419">► Note the messages on the driver's display.</p> <div data-bbox="535 440 1690 471" data-label="Section-Header"> <p>⚠ WARNING Risk of accident and injury if brake force boosting is malfunctioning</p> </div> <p data-bbox="545 481 1635 533">If brake force boosting is malfunctioning, increased brake pedal force may be necessary for braking. The braking characteristics may be impaired. The braking distance can increase in emergency braking situations.</p> <ul data-bbox="545 543 1164 606" style="list-style-type: none"> ► Stop in a safe location immediately. Do not continue driving. ► Consult a qualified specialist workshop. <div data-bbox="535 637 1690 668" data-label="Section-Header"> <p>⚠ WARNING Risk of an accident due to low brake fluid level</p> </div> <p data-bbox="545 678 1515 704">If the brake fluid level is too low, the braking effect and the braking characteristics may be impaired.</p> <ul data-bbox="545 714 1653 833" style="list-style-type: none"> ► Pull over and stop the vehicle safely as soon as possible, paying attention to road and traffic conditions. Do not continue driving under any circumstances. ► Consult a qualified specialist workshop. ► Do not add brake fluid.

Driving and driving safety systems

Warning/indicator lamp	Possible causes/consequences and ► Solutions
 <p data-bbox="144 381 323 405">ABS warning lamp</p>	<p data-bbox="463 288 1082 339">* The yellow ABS warning lamp is lit while the vehicle is running. ABS is malfunctioning.</p> <p data-bbox="476 350 1060 373">If an additional warning tone sounds, EBD is malfunctioning.</p> <p data-bbox="476 384 1230 408">Other driving systems and driving safety systems may also be malfunctioning.</p> <p data-bbox="476 418 925 442">► Note the messages on the driver's display.</p> <div data-bbox="482 464 1646 673" style="border: 1px solid black; padding: 5px;"> <p data-bbox="491 470 1203 494">▲ WARNING There is a risk of skidding if EBD or ABS is malfunctioning</p> <p data-bbox="491 508 851 532">The wheels may lock during braking.</p> <p data-bbox="491 542 1618 594">The steerability and braking characteristics are heavily impaired and the braking distance may increase. In addition, other driving safety systems are switched off.</p> <p data-bbox="491 605 707 628">► Drive on carefully.</p> <p data-bbox="491 639 1299 663">► Have the brake system checked immediately at a qualified specialist workshop.</p> </div>
 <p data-bbox="144 781 412 804">ESP® warning lamp flashes</p>	<p data-bbox="463 687 1143 739">* The yellow ESP® warning lamp flashes while the vehicle is in motion. One or more wheels have reached their grip limit (→ page 231).</p> <p data-bbox="476 750 1136 773">► Adapt your driving style to suit the road and weather conditions.</p>

Warning/indicator lamp	Possible causes/consequences and ► Solutions
 <p data-bbox="194 341 480 367">ESP® warning lamp lights up</p>	<p data-bbox="508 248 1145 305">* The yellow ESP® warning lamp is lit while the vehicle is running. ESP® is malfunctioning.</p> <p data-bbox="526 310 1386 336">Other driving systems and driving safety systems (e.g. BAS) may also be malfunctioning.</p> <ul style="list-style-type: none"> <li data-bbox="526 347 979 372">► Note the messages on the driver's display. <div data-bbox="526 388 1690 574" style="border: 1px solid black; padding: 5px;"> <p data-bbox="535 398 1099 429">▲ WARNING Risk of skidding if ESP® is malfunctioning</p> <p data-bbox="545 440 1653 492">If ESP® is malfunctioning, ESP® cannot carry out vehicle stabilization. In addition, other driving safety systems are switched off.</p> <ul style="list-style-type: none"> <li data-bbox="545 502 757 528">► Drive on carefully. <li data-bbox="545 538 1118 564">► Have ESP® checked at a qualified specialist workshop. </div>
 <p data-bbox="194 683 434 709">ESP® OFF warning lamp</p>	<p data-bbox="508 590 1191 647">* The yellow ESP® OFF warning lamp is lit while the vehicle is running. ESP® is deactivated.</p> <p data-bbox="526 652 1247 678">Other driving systems and driving safety systems may also be inoperative.</p> <div data-bbox="526 694 1690 849" style="border: 1px solid black; padding: 5px;"> <p data-bbox="535 704 1201 735">▲ WARNING Risk of skidding when driving with ESP® deactivated</p> <p data-bbox="545 745 1561 777">ESP® does not act to stabilize the vehicle. The availability of further driving safety systems is also limited.</p> <ul style="list-style-type: none"> <li data-bbox="545 787 757 813">► Drive on carefully. <li data-bbox="545 823 1145 849">► Deactivate ESP® only for as long as the situation requires. </div>

Warning/indicator lamp	Possible causes/consequences and ► Solutions
	<p>If ESP® cannot be activated, ESP® is malfunctioning.</p> <ul style="list-style-type: none">► Have ESP® checked immediately at a qualified specialist workshop. <p>► Observe the notes on deactivating ESP® (→ page 231).</p>
 <p>ATTENTION ASSIST warning lamp</p>	<p>* The ATTENTION ASSIST warning lamp is lit. ATTENTION ASSIST is malfunctioning.</p> <ul style="list-style-type: none">► Consult a qualified specialist workshop.
 <p>Distance warning lamp</p>	<p>* The red distance warning lamp lights up while the vehicle is in motion. The distance to the vehicle in front is too small for the speed selected. If there is an additional warning tone, you are approaching an obstacle at too high a speed.</p> <ul style="list-style-type: none">► Be prepared to brake immediately.► Increase the distance. <p>Function of Active Brake Assist (→ page 253).</p>

Warning/indicator lamp	Possible causes/consequences and ► Solutions
 <p data-bbox="194 341 471 393">Active Brake Assist warning lamp</p>	<ul style="list-style-type: none"> * The Active Brake Assist warning lamp is on. Due to dirty sensors or a malfunction, the system is not available or the range of functions is restricted. <ul style="list-style-type: none"> ► Note the messages on the driver's display.
 <p data-bbox="194 502 471 554">Active Brake Assist warning lamp</p>	<ul style="list-style-type: none"> * The Active Brake Assist warning lamp is on. The system is switched off or the range of functions has been automatically restricted. This may be the case if another driving system has been activated. <ul style="list-style-type: none"> ► Observe the notes on Active Brake Assist (→ page 253).
 <p data-bbox="194 663 471 714">Suspension warning lamp (yellow)</p>	<ul style="list-style-type: none"> * The yellow AIRMATIC / E-ACTIVE BODY CONTROL warning lamp is lit. A malfunction has occurred in AIRMATIC/E-ACTIVE BODY CONTROL. <ul style="list-style-type: none"> ► Note the messages on the driver's display.
 <p data-bbox="194 823 471 875">Suspension warning lamp (red)</p>	<ul style="list-style-type: none"> * The red AIRMATIC / E-ACTIVE BODY CONTROL warning lamp is lit. A malfunction has occurred in AIRMATIC/E-ACTIVE BODY CONTROL. <div style="border: 1px solid black; padding: 5px; margin-top: 10px;"> <ul style="list-style-type: none"> ! NOTE The vehicle's driving characteristics will have changed significantly. ► Consult a qualified specialist workshop. </div>

552 Display messages and warning/indicator lamps

Warning/indicator lamp	Possible causes/consequences and ► Solutions
	<ul style="list-style-type: none">► Note the messages on the driver's display.► Consult a qualified specialist workshop.

Mercedes-Benz emergency call system

Warning/indicator lamp	Possible causes/consequences and ► Solutions
 <p>Mercedes-Benz emergency call system warning lamp</p>	<p>*The Mercedes-Benz emergency call system is malfunctioning. The Mercedes me connect system is also malfunctioning.</p> <ul style="list-style-type: none">► Consult a qualified specialist workshop.

Tire pressure monitor

Warning/indicator lamp	Possible causes/consequences and ► Solutions
 <p>Tire pressure monitoring system warning lamp flashes</p>	<p>*The yellow tire pressure monitor warning lamp (pressure loss/malfunction) flashes for approximately one minute and then remains lit. The tire pressure monitoring system is malfunctioning.</p>

Warning/indicator lamp	Possible causes/consequences and ► Solutions
	<p>▲ WARNING There is a risk of an accident if the tire pressure monitoring system is malfunctioning</p> <p>The tire pressure monitoring system cannot issue a warning if there is pressure loss in one or more of the tires. Tires with insufficient tire pressure may impair the driving characteristics as well as steering and braking.</p> <p>► Have the tire pressure monitoring system checked at a qualified specialist workshop.</p>
 <p>Tire pressure monitoring system warning lamp lights up</p>	<p>* The yellow tire pressure monitoring system warning lamp (pressure loss/malfunction) is lit. The tire pressure monitoring system has detected tire pressure loss in at least one of the tires.</p> <p>▲ WARNING Risk of an accident due to insufficient tire pressure</p> <ul style="list-style-type: none"> • The tires can burst. • The tires can wear excessively and/or unevenly. • The driving characteristics as well as the steering and braking may be greatly impaired. <p>You could then lose control of the vehicle.</p> <p>► Observe the recommended tire pressures.</p> <p>► Adjust the tire pressure if necessary.</p> <p>► Stop the vehicle in accordance with the traffic conditions.</p> <p>► Check the tire pressure and the tires.</p>

1, 2, 3 ...			
(SmartKey) battery	78		
4MATIC	201		
48 V on-board electrical system			
Displays in the driver's display.....	310		
Operating safety.....	29		
A			
A/C function			
activating/deactivating (MBUX).....	159		
Activating/deactivating (operating unit).....	158		
ABS	230		
Acceleration			
Kickdown.....	200		
Optimized acceleration.....	175		
Accelerator pedal	190		
Accident, emergency call	360		
Activating/deactivating the acoustic locking verification signal	77		
Active Blind Spot Assist			
Activating/deactivating.....	263		
		Brake application.....	262
		Exit warning.....	260
		Function.....	260
		Trailer operation.....	262
		Active Brake Assist	
		Function.....	253
		Setting.....	257
		Active Distance Assist DISTRONIC	
		Activating/deactivating.....	241
		Active Emergency Stop Assist.....	250
		Active Lane Change Assist.....	251
		Calling up a speed.....	241
		Function.....	239
		Increases/decreases the speed.....	241
		Route-based speed adaptation.....	244
		Storing a speed.....	241
		Active Emergency Stop Assist	250
		Active headlamps	144
		Active Lane Change Assist	
		Activating/deactivating.....	253
		Function.....	251
		Active Lane Keeping Assist	
		Activating/deactivating.....	265
		Function.....	263
		Setting the sensitivity.....	265
		Towing a trailer.....	263
		Active light function	144
		Active Parking Assist	
		Automatic braking function.....	295
		Exiting a parking space.....	294
		Function.....	291
		Maneuvering brake function.....	296
		Parking.....	293
		Pausing.....	295
		Active Service System PLUS	370
		Active Speed Limit Assist	243
		Active Steering Assist	
		Activating/deactivating.....	250
		Active Emergency Stop Assist.....	250
		Active Lane Change Assist.....	251
		Function.....	248
		Active Stop-and-Go Assist	
		Function.....	246
		Adaptive cruise control	244
		Adaptive Highbeam Assist	
		Activating/deactivating.....	145

- Additives**
 Engine oil..... 455
 Fuel..... 454
- After-sales service**..... 370
- Air bag**
 Front air bag..... 60
 Inflating..... 55
 Overview..... 60
 PASSENGER AIR BAG indicator lamp..... 49
 Warning lamp..... 47
- Air conditioning menu**
 Air distribution..... 159
 Climate control..... 159
 Fragrance system..... 161
 Ionization..... 161
 Rear passenger compartment climate control..... 159
- Air distribution**
 Adjusting..... 159
 Setting..... 157
- Air freshener system**..... 161
- Air inlet**..... 378
- Air pressure**..... 415
- Air suspension**..... 266
- Air vents**
 Adjusting..... 166
 Glove box..... 167
- Air/water duct**..... 378
- Airflow**
 Setting..... 157
- AIRMATIC**
 Lowering/raising the rear end of the vehicle..... 271
 Setting entering/exiting level..... 271
 Setting the vehicle level..... 268
 Vehicle levels..... 266
- Alarm system**..... 98
- All-wheel drive**..... 201
- Alternative route**..... 344
- Ambient lighting**..... 146
- Animals**..... 57
- Anti-lock braking system**..... 230
- Anti-theft alarm system**..... 98
- Anti-theft protection**
 Immobilizer..... 98
- Anticipatory operating-mode strategy**,
 Route-based..... 190
- Apps, Mercedes me**
 Mercedes me calls..... 353
 Mercedes me connect..... 356
- Ashtray**
 In the center console..... 135
- Assistance system**..... 229
- ASSYST PLUS**
 Battery disconnection periods..... 371
 Service interval display..... 370
 Service requirements..... 370
- ATA**
 Deactivating the alarm..... 99
 Function..... 98
 Interior protection..... 100
 Interior protection function..... 100
 Tow-away alarm function..... 99
 Tow-away protection..... 100
- ATTENTION ASSIST**
 Function..... 235
 Setting..... 237
- Attention assistant**..... 235









- Authorized Mercedes-Benz Service Center..... 35
 Authorized workshop..... 35
 Automatic car wash..... 378
 Automatic car wash mode..... 380
 Automatic climate control..... 159
 Automatic distance control..... 239
 Automatic driving lights..... 142
 Automatic emergency call..... 361
 Automatic engine start/stop..... 182
 Automatic front passenger air bag shutoff
 Function..... 52
 Information (child restraint system on
 the front passenger seat)..... 66
 PASSENGER AIR BAG indicator lamp..... 49
 Automatic measures after an accident..... 54
 Automatic mirror folding function..... 155
 Automatic seat adjustment..... 111
 Automatic transmission
 DIRECT SELECT lever..... 196
 Drive programs..... 190
 DYNAMIC SELECT button..... 190
 Engages neutral..... 197
 Engaging drive position..... 198
 Engaging reverse gear..... 197
 Kickdown..... 200
 Manual gear shifting..... 198
 Oil temperature (driver's display)..... 308
 Selecting park position..... 197
 Steering wheel paddle shifters..... 198
 Switching gears..... 196
 Transmission position display..... 196
 Transmission positions..... 196
 Autonomous braking..... 253
- B**
- Back seat, Rear seat..... 105
 Bag hook..... 130
 Ball neck
 Installing..... 302
 BAS..... 230
 Basic information..... 44
 Battery
 High-voltage battery..... 399
 Battery (12 V battery)
 Charging..... 402
 Notes..... 397
 Notes (starting assistance and charg-
 ing)..... 400
 Replacing..... 403
 Starting assistance..... 402
 Battery (48 V)
 Notes..... 398
 Battery (high-voltage on-board electrical
 system)..... 465
 Battery (starter battery)
 charging, Remote Online..... 174
 Battery operation..... 168
 Belt
 Fastening..... 47
 Notes on wearing correctly..... 46
 Releasing..... 60
 To adjust the height..... 47
 Bicycle rack
 Load capacity..... 466
 Blind Spot Assist
 Activating/deactivating..... 263
 Function..... 260





































- Bluetooth®**
Connecting a mobile phone..... 352
- Boost pressure, current (driver's display).....** 308
- Brake Assist**
Active Brake Assist..... 253
Brake Assist System..... 230
- Brake Assist System.....** 230
- Brake disks.....** 175
- Brake fluid.....** 457
- Brake force distribution.....** 234
- Brake pads.....** 175
- Brakes**
ABS (Anti-lock Braking System)..... 230
Active Brake Assist..... 253
BAS (Brake Assist System)..... 230
Driving tips..... 176
EBD (Electronic Brakeforce Distribution)..... 234
Electric parking brake..... 224
Handbrake..... 224
HOLD function..... 234
Limited braking effect (salt-treated roads)..... 176
New/replaced brake pads/brake discs.. 175
Notes on breaking in a new vehicle..... 175
Parking brake..... 224
Post-collision brake..... 54, 55
Recuperation..... 186
- Braking assistance**
Brake Assist System..... 230
- Breakdown**
Changing a wheel..... 438
Flat tire..... 390
Overview of aids..... 22
Tow-starting..... 410
Towing methods..... 406
Transporting the vehicle..... 408
- Breakdown (Roadside Assistance).....** 29
- C**
- Calling the customer center for Mercedes-Benz.....** 353
- Calls**
Mercedes me..... 353
Telephone menu..... 352
Using overhead control panel..... 353
- Camera**
360° camera..... 281, 284
Button..... 287
Cleaning..... 383
Function..... 281
Information..... 228
Off-road function..... 284
Opening the camera cover (rear view camera)..... 287
Rear view camera..... 280
ROAD SURFACE SCAN..... 274
Select view..... 287
Transparent Hood..... 284
- Car key.....** 76
- Car wash**
Automatic car wash..... 378
Power washer..... 381
Washing by hand..... 381
- Car-to-X-Communication**
Display on map..... 346
- Care**
Air/water duct..... 378
Automatic car wash..... 378
Camera..... 383









































- Car parts..... 383
- Decorative foil..... 382
- Display..... 385
- Exterior lighting..... 383
- Head-up display..... 385
- Headliner..... 385
- Paint..... 381
- Plastic trim..... 385
- Power washer..... 381
- Real wood/trim elements..... 385
- Running boards..... 383
- Seat belts..... 385
- Steering wheel..... 385
- Trailer hitch..... 383
- Vehicle interior..... 385
- Vehicle socket for the high-voltage battery..... 383
- Washing by hand..... 381
- Wheels/rims..... 383
- Cargo compartment cover**
- Extending/retracting..... 127
- Notes..... 126
- Removing/installing..... 127
- Cargo compartment floor**
- Locking/unlocking..... 132
- Cargo tie-down rings**..... 130
- Caring for plastic trim**..... 385
- Caring for rims**..... 383
- Central display**
- Operating..... 323
- Central locking system**
- Button..... 80
- SmartKey..... 77
- Change of address**..... 29
- Change of ownership**..... 29
- Changing a wheel**
- Preparation..... 438
- Raising the vehicle..... 439
- Charge level display**..... 219
- Charge level/charge display**..... 219
- Charging**
- 12 V battery..... 402
- At time of departure..... 337
- Charge level display..... 219
- Charging cable control panel..... 210
- Charging station, mode 3..... 208
- Configuring weekly profile..... 337
- Emergency release of the socket flap..... 218
- Ending the charging process (alternating current, mode 2/3)..... 215
- Ending the charging process (direct current, mode 4)..... 217
- Indicator lamps on vehicle socket..... 211
- Mains socket, mode 2..... 207
- Notes on charging the high-voltage battery..... 204
- Notes on the high-voltage battery..... 399
- Rapid charging station, mode 4..... 209
- Setting the maximum permissible charging current (mains socket)..... 210
- Starting the charging process (alternating current, mode 2/3)..... 212
- Starting the charging process (direct current, mode 4)..... 216
- Stowing the charging cable..... 206
- USB port..... 122, 137
- Wallbox, mode 3..... 208
- Wirelessly charging a mobile phone..... 137
- Charging cable**
- Control panel..... 210
- Stowing..... 206
- Charging settings**..... 337
- Checking the coolant level**..... 377

- Child safety lock**
 Rear door..... 74
 Side windows (rear passenger compartment)..... 75
- Child seat**
 Adjusting the vehicle seat..... 68
 Basic instructions..... 62
 Front passenger seat..... 65
 Installing ISOFIX..... 70
 Rearward-facing..... 67
 Risks/dangers..... 63
 Securing on the rear seat with the seat belt..... 73
 Securing to the front passenger seat with the seat belt..... 73
 The most important information in brief.... 61
 Top Tether..... 72
- Children**
 Avoiding dangers in the vehicle..... 63
 Basic instructions..... 62
 Special seat belt retractor..... 69
- Chock**..... 437
- Clean varnish**..... 381
- Cleaning**
 Air/water duct..... 378
 Automatic car wash..... 378
 Car parts..... 383
 Decorative foil..... 382
 Paint..... 381
 Power washer..... 381
 Real wood/trim elements..... 385
 Sensors..... 383
 Vehicle interior..... 385
 Vehicle socket for the high-voltage battery..... 383
 Washing by hand..... 381
- Cleaning carpets**..... 385
- Cleaning seat covers**..... 385
- Climate control, Air-conditioning system, Blower, Cooling**
 Activating/deactivating..... 158
 Activating/deactivating (rear operating unit)..... 158
 Activating/deactivating the A/C function (control panel)..... 158
 Activating/deactivating the A/C function (MBUX)..... 159
 Activating/deactivating the synchronization function (control panel)..... 160
 Air vents (front)..... 166
 Air vents (rear passenger compartment)..... 167
 Automatic control..... 159
 Automatically controlling (rear operating unit)..... 159
 Control panel for 3-zone automatic climate control..... 157
 Control panel for dual-zone automatic climate control..... 157
 Defrosting the windshield..... 157
 Defrosting windows..... 160
 Filling capacity for refrigerant and PAG oil..... 460
 Fragrance system..... 161
 Glove box air vent..... 167
 Immediate pre-entry climate control..... 165
 Inserting/removing the flacon (fragrance system)..... 162
 Ionization..... 161
 Notes..... 157
 Pre-entry climate control for departure time..... 164
 Pre-entry climate control via SmartKey... 163

- Rear operating unit..... 20
- Rear passenger compartment operating unit..... 158
- Refrigerant..... 459
- Residual heat..... 160, 161
- Setting the air distribution..... 157
- Setting the airflow..... 157
- Setting the vehicle interior temperature..... 157
- Switching air-recirculation mode on/off..... 160
- Switching the rear window heater on/off..... 157
- Synchronization function..... 160
- Ventilating with convenience opening..... 91
- Coat hook**..... 131
- COC papers, CERTIFICATE OF CONFORMITY**..... 448
- Cockpit**
- Dashboard..... 10
- Instrument panel..... 6
- Coffee cup symbol**..... 235
- Collapsible spare wheel**
- Inflating..... 446
- Notes..... 445
- Removing..... 446
- Collision detection (parked vehicle)**
- Setting..... 226
- Combination switch**
- Lights..... 142
- Windshield wipers..... 147
- Commuter route**..... 344
- Components relevant to radio regulation**
- Declaration of conformity..... 33
- Control elements**..... 27
- Convenience closing**..... 91
- Convenience opening**..... 91
- Coolant**
- Capacity..... 458
- Notes..... 457
- Copyright**
- License..... 43
- Copyrights**
- Trademarks..... 43
- Correct use**..... 35
- Cover**..... 93
- Cross traffic (warning)**..... 296
- Cross Traffic Alert**, Cross traffic warning..... 296
- Crosswind Assist**..... 232
- Cruise control**
- Activating/deactivating..... 238
- Calling up a speed..... 238
- Function..... 237
- Requirements..... 238
- Setting a speed..... 238
- Storing a speed..... 238
- Customer Assistance Center (CAC)**..... 37
- Customer Relations Department**..... 37
- D**
- Damage**
- Limited protection..... 57
- Damping system ADS PLUS**
- AIRMATIC..... 266
- E-ACTIVE BODY CONTROL..... 272
- Setting the vehicle level..... 268
- Dashboard**
- Cockpit..... 10

- Dashcam**
 Notes..... 348
 Selecting a USB device..... 348
 Starting/stopping a video recording..... 349
- Data processing in the vehicle**..... 38
- Data protection rights**..... 41
- Data storage**
 Data protection rights..... 41
 Electronic control units..... 38
 Event Data Recorder..... 42
 MBUX multimedia system/Mercedes
 me connect..... 42
 Online services..... 41
- Daytime running lamps, Daytime running
 lamp mode**
 Activating/deactivating..... 145
- Deactivating the alarm**..... 99
- Dealership**..... 35
- Declaration of conformity**
 Components relevant to radio regulation.. 33
- Decorative foil**..... 382
- Definitions**
 Tires and loading..... 431
- Deployed components**
 Limited protection..... 57
- Deployment situations**..... 55
- Destination entry**..... 342
- Detecting inattentiveness**..... 235
- Diagnostics connection**..... 34
- Digital Operator's Manual**..... 24
- Dinghy towing**
 Pulling/towing..... 305
- Direct commands**
 Voice commands for MBUX voice
 assistant..... 319
- DIRECT SELECT lever**
 Automatic transmission..... 196
 Engages neutral..... 197
 Engaging drive position..... 198
 Engaging park position automatically..... 197
 Engaging reverse gear..... 197
 Function..... 196
 Gearshift recommendation..... 199
 Manual gearshifting..... 198
 Selecting park position..... 197
- Display**
 Care..... 385
- Display (driver's display)**
 Overview of displays..... 311
- Display message**
 Calling up on driver display..... 468
 Notes..... 468
- Display messages**
 --- mph..... 514
 --- mph..... 508
 2nd Seat Row, Center Not
 Locked..... 491
 2nd Seat Row, Left Not Locked.... 490
 2nd Seat Row, Right Not Locked.. 490
 3rd Seat Row, Left Not Locked.... 492
 3rd Seat Row, Right Not Locked... 492
 12 V On-board Electrical Sys-
 tem Service Required..... 525
 48 V Battery See Operator's
 Manual..... 527

-  Acoustic Presence Indicator Inoperative..... 480
-  Active Headlamps Inoperative..... 476
-  Add Washer Fluid..... 493
-  ATTENTION ASSIST: Take a Break!..... 507
-  Automatic Driving Lights Inoperative..... 476
-  Battery Overheated Stop! Everyone Get Out! Outdoors if Possible..... 482, 527
-  Camera View Reduced See Operator's Manual..... 522
-  Cannot Fold 2nd Seat Row See Operator's Manual..... 491
-  Cannot Fold Forward 2nd Seat Row, Left Adjust Front Seat..... 491
-  Cannot Fold Forward 2nd Seat Row, Right Adjust Front Seat..... 492
-  Charger Cable Connected..... 480
-  Check Brake Fluid Level..... 503
-  Check Coolant Level See Operator's Manual..... 494
-  Check Engine Oil Level At Next Refueling (Add 1 Quart)..... 534
-  Check Left Low Beam (example).. 475
-  Check Tires..... 529
-  Compressor Is Cooling..... 510
-  Coolant Stop Switch Off Vehicle... 494
-  Currently Not Available Charge High-voltage Battery..... 479
-  Currently Not Available Charging of the High-voltage Battery Not Completed..... 478
-  Currently Unavailable See Operator's Manual..... 504
-  Currently Unavailable See Operator's Manual..... 505
-  Don't Forget Your Key..... 475
-  Dynamic Low Beam Inoperative... 477
-  Engine Oil Level Cannot Be Measured..... 536
-  Engine Oil Level Reduce Oil Level..... 534
-  Engine Oil Level Stop Switch Off Vehicle..... 534
-  Engine Oil Pressure Stop Switch Off Vehicle..... 535
-  Front Left Malfunction Service Required (example)..... 470
-  Fuel Filler Cap Open..... 495
-  Fuel Level Low..... 495
-  Fuel Tank Is Depressurized Ready for Refueling..... 485
-  Functions Limited When Towing Trailer..... 523
-  Initializing Key Please Wait..... 474
-  Initiating Emergency Stop..... 517
-  Inoperative See Operator's Manual..... 505

-  Inoperative See Operator's Manual..... 506
-  Inoperative See Operator's Manual..... 507
-  Inoperative..... 525
-  Inoperative..... 513
-  Key Not Detected (red display message)..... 474
-  Key Not Detected (white display message)..... 473
-  Left Window Airbag Malfunction Service Required (example)..... 471
-  Lowering..... 510
-  Malfunction Drive at Max. 50 mph..... 509, 512
-  Malfunction See Operator's Manual..... 476
-  Malfunction Service Required..... 483
-  Malfunction Stop..... 512
-  Malfunction..... 484
-  Malfunction..... 483
-  Max. Speed 25 mph..... 513
-  Not in Curr. Drive Prog..... 513
-  Obtain a New Key..... 473
-  Off..... 514
-  Off..... 507
-  Parking Brake See Operator's Manual..... 499
-  Performance Extremely Limited.... 484
-  Please Correct Tire Pressure..... 530
-  Please Wait Charging 48 V Battery..... 527
-  Please Wait Depressurizing Fuel Tank..... 485
-  Pre-entry Climate Control Available Again via SmartKey after Vehicle Start..... 479
-  Pre-entry Climate Control via SmartKey Currently Not Available. High-voltage Battery Low..... 479
-  Reduce Speed..... 532
-  Release Parking Brake..... 502
-  Replace Key Battery..... 473
-  Restraint System Malfunction Service Required..... 469
-  Rising..... 510
-  Slow Down..... 511
-  Steering Malfunction Increased Physical Effort See Operator's Manual.... 488
-  Steering Malfunction Stop Immediately See Operator's Manual..... 489
-  Stop Switch Off Vehicle..... 484
-  Stop Vehicle See Operator's Manual..... 525
-  Stop Vehicle To Charge the 12 V Battery Do Not Switch Off Vehicle..... 526
-  Suspended..... 514
-  Switch Off Lights..... 477
-  Switch On Headlights..... 476

-  Switch on vehicle to charge the 12 V battery..... 526
-  Switch on Vehicle to Release the Parking Brake..... 503
-  Tank Ventilation Malfunction Service Required..... 485
-  Temporarily Unavailable Sensors Dirty..... 521
-  Tires Overheated..... 531
-  Towing Not Permitted See Operator's Manual..... 480
-  Vehicle Ready to Drive Shutdown Occurs When Locked or After a Few Minutes..... 487
-  Vehicle Rising Please Wait..... 510
-  Warning Tire Malfunction..... 531
-  Wheel Sensor(s) Missing..... 529
- "Electric" Drive Program Currently Unavailable..... 482
- Active Blind Spot Assist Currently Unavailable See Operator's Manual..... 519
- Active Blind Spot Assist Inoperative..... 519
- Active Blind Spot Assist Not Available When Towing Trailer See Operator's Manual..... 520
- Active Brake Assist Functions Currently Limited See Operator's Manual..... 515
- Active Brake Assist Functions Limited See Operator's Manual..... 516
- Active Distance Assist Currently Unavailable See Operator's Manual..... 514
- Active Distance Assist Inoperative..... 515
- Active Distance Assist Now Available..... 515
- Active Lane Keeping Assist Currently Unavailable See Operator's Manual..... 520
- Active Lane Keeping Assist Inoperative... 520
- Active Lane Keeping Assist Limited Range of Functions See Operator's Manual..... 520
- Active Parking Assist and PARKTRONIC Inoperative See Operator's Manual..... 524
- Active Steering Assist Currently Unavailable Due to Multiple Emergency Stops..... 517
- Active Steering Assist Currently Unavailable See Operator's Manual..... 516
- Active Steering Assist Inoperative..... 517
- Active Stop & Go Assist Currently Unavailable See Operator's Manual..... 517
- Active Stop & Go Assist Inoperative See Operator's Manual..... 518
- Adaptive Highbeam Assist Currently Unavailable See Operator's Manual..... 477
- Adaptive Highbeam Assist Inoperative.... 477
- Auxiliary Battery Malfunction (red display message)..... 498
- Auxiliary Battery Malfunction (white display message)..... 498

- Blind Spot Assist Currently Unavailable See Operator's Manual..... 518
- Blind Spot Assist Inoperative..... 518
- Blind Spot Assist Not Available When Towing Trailer See Operator's Manual..... 519
- Cannot Start Vehicle See Operator's Manual..... 493, 528
- Charging Fault Change Charging Mode See Operator's Manual..... 481
- Charging Mode Currently Unavailable Try Again or Change Charging Mode..... 481
- Check Brake Pads See Operator's Manual..... 504
- Check Tire and Tire Pressure..... 532
- Check Tire Pressure Then Restart Run Flat Indicator..... 533
- Cruise Control Inoperative..... 508
- Cruise Control Off..... 508
- Depress Brake to Shift from P..... 496
- Depress Brake to Shift to D or R..... 496
- Depress Brake to Shift to R..... 496
- Do Not Restart Vehicle Service Required..... 483
- Do Not Shift Gears Service Required..... 483
- Front Passenger Airbag Disabled See Operator's Manual..... 471
- Front Passenger Airbag Enabled See Operator's Manual..... 472
- Hazard Warning Light Malfunction..... 478
- Head-up Display Currently Unavailable See Operator's Manual..... 488
- Head-up Display Inoperative..... 488
- Not Possible to Unlock Charging Cable See Operator's Manual..... 480
- Only Electric Drive Available Power Limited..... 481
- PARKTRONIC Inoperative See Operator's Manual..... 524
- Place the Key in the Marked Space See Operator's Manual..... 475
- PRE-SAFE Inoperative See Operator's Manual..... 523
- PRE-SAFE Pulse Side Inoperative See Operator's Manual..... 523
- Reduced Drive System Performance See Operator's Manual..... 482
- Reversing Not Possible Service Required..... 497
- Risk of Vehicle Rolling Away Apply Parking Brake When Parking..... 497
- Risk of Vehicle Rolling Away Driver's Door Open Position P Not Selected..... 497
- Service Required Apply Parking Brake to Park..... 497
- Service Required Do Not Change Transmission Position..... 498
- Shift to P Only When Vehicle Is Stationary..... 496
- Starting Possible Again..... 528

- Stop Vehicle Leave Engine Running
 Wait Transmission Cooling..... 498
 Tire Pressure Monitor Currently
 Unavailable..... 528
 Tire Pressure Monitor Inoperative... 529, 533
 Tire Pressure Monitor Inoperative Tire
 Pressure Sensors Missing..... 529
 To Deselect P or N Depress Brake and
 Start Vehicle..... 496
 To Switch Off Vehicle Press and Hold
 Start/Stop Button for at Least 3 Sec-
 onds or Press 3 Times..... 493
 Traffic Sign Assist Currently Unavaila-
 ble See Operator's Manual..... 508
 Traffic Sign Assist Inoperative..... 508
 Transmission Malfunction Stop..... 497
 Vehicle Currently Not Charging...
 Charging Station Fault..... 481
- Vehicle Ready to Drive Shutdown
 Occurs When Locked or Automatically
 in XX Mins..... 487
 Windshield Wiper Malfunction..... 493
Displaying road names/house numbers..... 344
Distance control..... 239
Distance warning..... 253
DISTRONIC..... 239
Door
 Child safety lock (rear door)..... 74
 Emergency key..... 83
 Opening (from the inside)..... 80
 Power closing function..... 83
 Unlocking (inside)..... 80
**Door control panel (rear passenger com-
 partment)**..... 20
Door operating unit
 Function seat..... 18
DOT, Tire Identification Number (TIN)..... 427
Downhill Speed Regulation..... 246
Drinking and driving..... 176
Drinks holder, Cup holder..... 134
Drive Away Assist..... 295
Drive position..... 198
Drive program display..... 194
Drive programs
 Selecting..... 194
Driver's display, Instrument cluster
 48 V on-board electrical system..... 310
 Head-up display..... 309
 Menus..... 307
 Notes..... 306
 Operating..... 306
 Service due date..... 370
 Status displays..... 311
 Warning/indicator lamps..... 536
Driver's seat
 Adjusting electrically..... 102
 Easy entry and exit feature..... 116
 Seat heating..... 112
Driving off-road..... 180
Driving safety system
 ABS (Anti-lock Braking System)..... 230
 Active Brake Assist..... 253

- ATTENTION ASSIST..... 235
- BAS (Brake Assist System)..... 230
- Blind Spot Assist/Active Blind Spot Assist..... 260
- Cameras..... 228
- Cruise control..... 237
- EBD (Electronic Brakeforce Distribution)..... 234
- ESP® (Electronic Stability Program)..... 231
- Hill Start Assist..... 235
- HOLD function..... 234
- Off-road ABS..... 230
- Overview..... 229
- Radar and ultrasonic sensors..... 228
- STEER CONTROL..... 234
- Traffic Sign Assist..... 258
- Trailer Maneuvering Assist..... 298
- Your responsibility..... 228
- Driving system**..... 229
- Driving tips**
- Drinking and driving..... 176
 - General driving tips..... 176
 - Notes on breaking in a new vehicle..... 175
 - Off-road driving..... 180
 - Optimized acceleration..... 175
- Recuperation..... 186
- Drowsiness detection**..... 235
- DSR**
- Activating/deactivating..... 247, 248
 - Changing the target speed..... 248
 - Function..... 246
 - Notes..... 247
- Duplicate key**..... 79
- Dynamic handling control system**..... 231
- DYNAMIC SELECT**
- Calling up the fuel consumption indicator..... 196
 - Configuring drive program I..... 194, 195
 - Displaying engine data..... 195
 - Displaying vehicle data..... 195
 - Drive program display..... 194
 - Drive programs..... 190
 - Function..... 190
 - Selecting the drive program..... 194
- E**
- E-ACTIVE BODY CONTROL**
- Electrohydraulic suspension..... 272
 - Individual wheel control..... 276
- Recovery mode..... 275
- ROAD SURFACE SCAN..... 274
- Setting the vehicle level..... 276
- Suspension..... 272
- Vehicle levels..... 272
- E-mails**..... 318
- E10**..... 453
- Easy entry feature**
- Adjusting..... 117
- Easy exit feature**
- Adjusting..... 117
- EASY-PACK load-securing kit**
- Installing/removing the telescopic rod... 131
 - Notes..... 131
- EBD, Electronic Brakeforce Distribution**..... 234
- ECO Assist**
- 48 V on-board electrical system..... 185
 - Activating/deactivating..... 189
 - Plug-in hybrid..... 188
- ECO display**..... 184
- ECO start/stop button**
- Automatic engine start/stop..... 183

- ECO start/stop function**
 Automatic engine start..... 182
 Automatic engine stop..... 182
 Function..... 182
 Switching off/on..... 183
- Electric drive**..... 168
- Electric parking brake**
 Applying automatically..... 224
 Emergency braking..... 225
 Manually applying/releasing..... 225
 Releasing automatically..... 225
- Electrical fuses**..... 410
- Electrohydraulic chassis**..... 272
- Electrohydraulic suspension**..... 272
- Electronic Stability Program**..... 231
- Emergency**
 First-aid kit (soft sided)..... 390
 Overview of aids..... 22
 Reflective safety vest..... 388
 Warning triangle..... 390
- Emergency braking**
 Active Brake Assist..... 253
 Brake Assist System..... 230
- Carrying out..... 225
 Electric parking brake/handbrake..... 224
- Emergency key**
 Door..... 83
 Tailgate..... 89
- Emergency operation mode**
 Starting the vehicle..... 173
- Emergency release**
 Socket flap..... 218
- Emergency shutoff (high-voltage on-board electrical system)**..... 170
- Emergency spare wheel**
 Inflating..... 444
- Emergency stop assistant**..... 250
- Emergency Tensioning Devices**
 Inflating..... 55
- Energy flow display**
 Function/notes..... 338
- Engine**
 Emergency operation mode..... 173
 Emergency start..... 410
 Engine number..... 450
 Jump-starting..... 400
- Parking (start/stop button)..... 219
- Engine data**
 Displaying..... 195
 DYNAMIC SELECT..... 195
- Engine number**..... 450
- Engine oil, Oil**
 Additives..... 455
 Capacity..... 455
 Checking the oil level using the driver display..... 375
 MB-Freigabe / MB-Approval..... 455
 Quality..... 455
 Refilling..... 375
 Temperature (driver's display)..... 308
- Engine oil temperature (driver's display)**..... 308
- Engine output, current (driver's display)**..... 308
- Environmentally friendly driving**..... 25
- ESC, Electronic Stability Control**..... 231
- ESP®**
 Activating/deactivating..... 233
 Activating/deactivating (button)..... 233
 Crosswind Assist..... 232
 Function..... 231

- Trailer stabilization..... 232
- Event Data Recorder**..... 42
- Exit warning**..... 260
- Exiting a parking space**
- Active Parking Assist..... 291
 - Drive Away Assist..... 295
 - PARKTRONIC..... 287
- Exterior lighting**
- Care..... 383
- Exterior mirrors**
- Parking position..... 154
- F**
- Factory settings**
- MBUX reset function..... 336
- Favorites**..... 330
- First aid**
- First-aid kit (soft sided)..... 390
- First-aid kit (soft sided)**..... 390
- Fitting accessories**
- Limited protection..... 57
- Flacon**..... 162
- Flat tire**
- Changing a wheel..... 438
 - MOExtended..... 391
 - Notes..... 390
 - TIREFIT kit..... 393
- Flat towing**
- Pulling/towing..... 305
- Floor mats**..... 139
- Fog lamp**..... 142
- Foil covering**
- On camera/sensors..... 228
 - Radar and ultrasonic sensors..... 228
- Fragrance**..... 161
- Fragrance system**
- Activating/deactivating..... 161
 - Adjusting..... 161
 - Inserting/removing the flacon..... 162
 - Perfume vial..... 162
- Free driving mode**
- Starting..... 279
- Free software**..... 43
- Frequencies**
- Two-way radio..... 449
- Front air bag**
- Inflating..... 55
- Front headlamps**..... 141
- Front passenger air bag**
- Disabling/enabling..... 51
- Front passenger air bag shutoff, PASSENGER AIR BAG OFF**
- Information (child restraint system on the front passenger seat)..... 66
- Front passenger seat**
- Adjusting electrically..... 102
 - Adjusting from driver's seat..... 104
- Fuel**
- Additives..... 454
 - Depressurize the fuel tank (plug-in hybrid with gasoline engine)..... 203
 - E10..... 453
 - Gasoline..... 453
 - Gasoline quality..... 453
 - Refilling..... 201
 - Reserve..... 454
 - Sulfur content..... 453
 - Tank capacity..... 454
- Fuel consumption indicator**..... 196

- Fuel reserve**..... 454
- Function in the event of an accident**..... 55
- Function seat**..... 18
- Function seat (rear passenger compartment)**..... 20
- Fuses**
- Cargo compartment..... 412
 - Cockpit..... 412
 - Engine compartment..... 411
 - Front passenger footwell..... 412
 - Fuse assignment diagram..... 410
 - Notes..... 410
- G**
- G-meter, Accelerometer**..... 308
- Garage door opener**
- Clearing the memory..... 224
 - Opening/closing a door..... 223
 - Problem..... 223
- Garage door openers**
- Programming buttons..... 221
 - Synchronizing the rolling code..... 223
- Gasoline**..... 453
- Gearshift**
- DIRECT SELECT lever..... 196
 - Manual..... 198
- General driving tips**..... 176
- Genuine parts**..... 26
- Glide mode**..... 200
- Glove box**
- Air vent..... 167
- Grab handles**..... 101
- H**
- Handbrake**..... 224
- Handling characteristics**
- Unusual..... 414
- HANDS-FREE ACCESS**..... 87
- Haptic accelerator pedal, Pressure point**..... 190
- Hazard warning lights**..... 143
- Hazard warnings**
- Car-to-X-Communication..... 346
- Head restraint**
- Adjusting (rear passenger compartment)..... 110
 - Adjusting manually (front)..... 108
 - Luxury head restraint (front)..... 109
 - Removing/installing (rear passenger compartment)..... 110
- Head-up display**
- Care..... 385
 - Function..... 309
 - Memory function..... 118
 - Operating..... 309
 - Switching on/off..... 310
- Headlamp flashing**..... 142
- Headlamps**..... 141
- Heating**
- Activating/deactivating..... 158
 - Center console..... 158
 - Panel heating..... 113
 - Seat..... 112
 - Steering wheel..... 116
- Help call**
- Mercedes-Benz emergency call system.. 360
- High beam**..... 142
- High-voltage battery**
- Charge level display..... 219
 - Charging at time of departure..... 337

- Charging cable control panel..... 210
 Charging duration..... 465
 Charging station, mode 3..... 208
 Configuring weekly profile..... 337
 Ending the charging process (alternating current, mode 2/3)..... 215
 Ending the charging process (direct current, mode 4)..... 217
 Energy flow display..... 338
 General notes on charging..... 204
 Mains socket, mode 2..... 207
 Notes..... 399
 Range..... 465
 Rapid charging station, mode 4..... 209
 Setting the maximum permissible charging current (mains socket)..... 210
 Starting the charging process (alternating current, mode 2/3)..... 212
 Starting the charging process (direct current, mode 4)..... 216
 Stowing the charging cable..... 206
 Type..... 465
 Wallbox, mode 3..... 208
- High-voltage on-board electrical system**
 Indicator lamps on vehicle socket..... 211
- Manual switch-off..... 170
 Operating safety..... 29
- Hill descent control**..... 246
- Hill Start Assist**..... 235
- HOLD function**
 Function..... 234
 Switching on/off..... 234
- Home screen**
 Central display..... 322
- Hood**
 Opening/closing..... 372
- I**
- Identification plate**
 Engine..... 450
 Refrigerant..... 459
 Vehicle..... 450
- Immediate pre-entry climate control**..... 165
- Immobilizer**..... 98
- Incorrect behavior by vehicle occupants**
 Limited protection..... 57
- Indicator/warning lamp**..... 536
- Indicator/warning lamps**
 PASSENGER AIR BAG..... 49
- Individual drive program**
 Configuring..... 194, 195
- Inside rearview mirror**..... 153
- Installing**
 Snow chains..... 415
 Tires/wheels..... 441
- Instrument display**
 Instrument cluster..... 12
- Instrument panel**
 Cockpit..... 6
- Intelligent Light System**
 Active headlamps..... 144
 Adaptive Highbeam Assist..... 144
- Interior lighting**
 Adjusting..... 146
 Ambient lighting..... 146
 MBUX reading light..... 328
 Switch-off delay time..... 147
- Interior protection**..... 100
- Internet**
 Mercedes me connect..... 356

Setting up a Wi-Fi hotspot.....	334		
Web browser.....	358		
Ionization	161		
ISOFIX child seat anchor			
Installing.....	70		
J			
Jack			
Storage location.....	437		
Jump-start connection	402		
K			
Key			
Problem.....	79		
Replacement key.....	79		
KEYLESS-GO			
Deactivating.....	77		
Locking/unlocking the vehicle.....	81		
Problem.....	81		
Unlocking setting.....	77		
Kickdown	200		
Knee air bag	60		
L			
Lane change assist	251		
Lane Keeping Assist	263		
Lane recognition			
Active Lane Change Assist.....	251		
Lane recognition (automatic)			
Active Lane Keeping Assist.....	263		
Lane scan	274		
Language			
Notes.....	336		
Setting.....	336		
Level control			
AIRMATIC.....	266		
E-ACTIVE BODY CONTROL.....	272		
License plate (front)	33		
License plate assembly (front)	33		
Light switch	141		
Lighting			
Interior lighting.....	146		
Lights			
Active headlamps.....	144		
Adaptive Highbeam Assist.....	144		
Automatic driving lights.....	142		
Combination switch.....	142		
Hazard warning lights.....	143		
High beam.....	142		
Interior lighting.....	146		
Locator lighting.....	146		
Reading lamp.....	146		
Reading light.....	328		
Rear fog light.....	142		
Responsibility for lighting systems.....	141		
Switch-off delay time.....	146		
Switching on the daytime running lamps.....	145		
Turn signals.....	142		
Limited Warranty	38		
Live Traffic Information	346		
Load capacity			
Bicycle rack.....	466		
Load index			
Tires.....	429		
Load-bearing capacity			
Tires.....	429		
Loading, Stowage compartments			
Bag hook.....	130		

- Cargo tie-down rings..... 130
- Coat hook..... 131
- Definitions..... 431
- Roof luggage rack..... 133
- Loading guidelines**..... 119
- Loading information table**..... 422
- Loads**..... 119
- Locator lighting**..... 146
- Locking/unlocking**
 - Automatic locking (MMS)..... 82
 - Doors (from the inside)..... 80
 - Emergency key..... 83
 - KEYLESS-GO..... 81
- Loud sound**
 - PRE-SAFE® Sound..... 53
- Low-beam headlamps**
 - Activating/deactivating..... 141
- Lowering/raising the loading sill**..... 271
- Lowering/raising the rear of the vehicle**..... 271
- Lubricants**..... 452
- Luggage**..... 119
- Luggage rack**..... 119
- Lumbar support**..... 105
- M**
- MAGIC VISION CONTROL**
 - Windshield wiper..... 150
- Maintaining safe distance**
 - Active Distance Assist DISTRONIC..... 241
- Maintaining the headliner**..... 385
- Maintaining the steering wheel**..... 385
- Maintenance**
 - Vehicle..... 29
- Maintenance Management**
 - Notes..... 371
 - Transferred data..... 371
- Malfunction**
 - Restraint system..... 47
- Malfunction message**
 - Driver's display..... 468
- Maneuvering**
 - Maneuvering brake function..... 296
- Maneuvering assistance**
 - Activating/deactivating..... 297
- Maneuvering assistant**
 - Drive Away Assist..... 295
 - Maneuvering brake function..... 296
- Maneuvering brake function**..... 296
- Manual gearshifting**
 - Activating/deactivating..... 199
- Map**
 - Displaying online map contents..... 346
 - Displaying weather information..... 346
 - Moving..... 345
 - Selecting the map orientation..... 345
 - Setting the map scale..... 345
- Map functions**..... 345
- Massage program**..... 112
- Massage programs**..... 112
- Maximum full-stop braking**..... 230
- Maximum load rating**..... 428
- Maximum permissible load**
 - Calculation example..... 424
 - Determining..... 423
- Maximum tire pressure**..... 428

- MBUX**
 - Dashcam..... 348
- MBUX Interior Assistant**
 - Overview..... 326
 - Reading light..... 328
 - Search light..... 328
- MBUX multimedia system**
 - Activating/deactivating DSR..... 248
 - Activating/deactivating standby mode... 228
 - Drive programs..... 194, 195
 - Factory setting..... 336
 - Home screen..... 322
 - Language settings..... 313, 325
 - MBUX Interior Assistant..... 326
 - Media..... 363
 - Mercedes me & Apps..... 358
 - Notes..... 321
 - Overview..... 321
 - Set collision detection..... 226
 - Setting route-based speed adaptation.... 245
 - Standby mode function..... 227
 - Steering wheel heater / seat heating.... 116
 - Telephone..... 350
 - Touchscreen..... 323
- MBUX reading light**..... 328
- MBUX search light**..... 328
- MBUX voice assistant**
 - E-mails..... 318
 - Function..... 313, 325
 - Language setting..... 314
 - Media voice commands..... 317
 - Online voice commands..... 319
 - Online voice control..... 316
 - Operable functions..... 314
 - Operating safety..... 313
 - Setting..... 315
 - Speech quality..... 315
 - Voice commands..... 316
 - Voice prompting..... 313, 325
- Mechanical key**
 - Inserting/removing..... 78
- Media**
 - Overview of functions/symbols..... 363
- Medical aids**..... 36
- Memory function**
 - Head-up display..... 118
 - Outside mirrors..... 118
 - Seat..... 118
- Menus (driver's display)**
 - Notes..... 307
 - Sport..... 308
- Mercedes me App**
 - Activating on-demand features..... 28
- Mercedes me Apps**..... 358
- Mercedes me calls**
 - Arranging a service appointment..... 355
 - Calling the Mercedes-Benz customer center after automatic accident/breakdown detection..... 354
 - Calls via the overhead control panel..... 353
 - Information..... 353
 - Mercedes-Benz customer center..... 353
 - Transferred data..... 355
- Mercedes me connect**
 - Accident/Breakdown Management..... 357
 - Information..... 356
 - Transferred data..... 358
- Mercedes-AMG vehicles, Notes**..... 168
- Mercedes-Benz emergency call system, Emergency call**
 - Automatic emergency call..... 361
 - Data transfer..... 362

Information.....	360
Manual emergency call.....	361
Overview.....	360
Mercedes-Benz GenuineParts.....	26
Message memory.....	468
Messages	
MBUX voice commands.....	318
Mirrors	
Mirror folding function.....	155
Outside mirrors.....	152
Rearview mirror.....	153
Mobile phone	
Notes on wireless charging.....	137
Model type.....	450
Modification	
Limited protection.....	57
MOExtended tires, Run-flat tires.....	391
Multifunction camera	
ROAD SURFACE SCAN.....	274
Multimedia system.....	321

N**Navigation**

Activating.....	340
Destination entry.....	342
MBUX voice commands.....	317
Notes.....	339
Overview.....	340
Neutral.....	197

Non-operational time

Activating/deactivating standby mode...	228
---	-----

Notes on breaking in a new vehicle.....	175
--	------------

O**Objects in the vehicle interior**

Limited protection.....	57
-------------------------	----

Occupant safety

Air bag.....	60
Basic information.....	44
Child seat.....	62
Information on the child restraint system.....	51
Information on the correct seat position...	45
Pets in the vehicle.....	57

PRE-SAFE®.....	53
----------------	----

Off-road ABS.....	230
--------------------------	------------

Off-road Assist

Setting.....	279
--------------	-----

Off-road driving.....	180
------------------------------	------------

Off-road menu

Overview.....	338
Setting.....	339

On-board diagnostics interface.....	34
--	-----------

On-board electronics

Two-way radios.....	448
---------------------	-----

On-demand feature.....	28
-------------------------------	-----------

Online services.....	41
-----------------------------	-----------

Open Source Software.....	43
----------------------------------	-----------

Opening angle

Limiting (tailgate).....	89
--------------------------	----

Opening the tailgate using your foot

HANDS-FREE ACCESS.....	87
------------------------	----

Opening/closing a door.....	223
------------------------------------	------------

Opening/closing a garage door.....	223
---	------------

- Operating fluids**
- Additives..... 454
 - Brake fluid..... 457
 - coolant..... 457
 - Engine oil..... 455
 - Gasoline..... 453
 - Notes..... 452
 - Refrigerant (air conditioning system)..... 459
 - Windshield washer fluid..... 458
- Operating safety**
- 48 V on-board electrical system..... 29
 - High-voltage on-board electrical system... 29
- Operator's manual**..... 27
- Operator's Manual digital**..... 24
- Outside mirrors**
- Automatic anti-glare mode..... 153
 - Automatic mirror folding function..... 155
 - Blind Spot Assist/Active Blind Spot Assist..... 260
 - Folding in/out..... 152
 - Memory function..... 118
 - Setting..... 152
 - Warning lamp..... 260
- Overhead control panel**..... 16
- Overview of air bags**..... 60
- P**
- Paddle shifters**
- Steering wheel paddle shifters..... 198
- Paint code**..... 450
- Panel heating**..... 113
- Panic alarm, Alarm**
- Activating/deactivating..... 77
- Park position**
- DIRECT SELECT lever..... 196
- Parking**
- Active Parking Assist..... 291
 - PARKTRONIC..... 287
- Parking Assist**
- Active Parking Assist..... 291
 - PARKTRONIC..... 287
- Parking Assist PARKTRONIC**
- Activating/deactivating..... 290
 - Adjusting warning tones..... 290
 - Function..... 287
- Parking assistance systems**
- Active Parking Assist..... 291
 - Drive Away Assist..... 295
 - Maneuvering brake function..... 296
 - PARKTRONIC..... 287
- Parking brake**..... 224
- Parking for an extended period**..... 227
- Parking lamp**..... 141
- Parking position**
- Exterior mirrors..... 154
 - Storing the position of the front-passenger outside mirror using reverse gear..... 155
- PARKTRONIC**..... 287
- Partition net**
- Removing/installing..... 128
- Partitioning net**..... 129
- PASSENGER AIR BAG**
- Status display, front passenger air bag.... 49
- Payload**
- Calculation example..... 424
 - Determining the maximum..... 423
- Permitted towing methods**
- Overview..... 403, 405

- Personalization**..... 329
- Pets in the vehicle**..... 57
- Plug-in hybrid operation**
- Charging cable control panel..... 210
 - Charging the high-voltage battery at a rapid charging station (mode 4)..... 209
 - Ending the charging process (alternating current, mode 2/3)..... 215
 - Ending the charging process (direct current, mode 4)..... 217
 - Function of the regenerative brake system..... 186
 - Functions of the energy flow display..... 338
 - Haptic accelerator pedal..... 190
 - Indicator lamps on vehicle socket..... 211
 - Manually disconnecting the high-voltage on-board electrical system..... 170
 - Notes on charging (charging station, mode 3)..... 208
 - Notes on charging (mains socket, mode 2)..... 207
 - Notes on charging (wallbox, mode 3)..... 208
 - Notes on plug-in hybrid operation..... 168
 - Operating safety..... 29
 - Power meter..... 310
- Route-based operating-mode strategy.... 190
 - Sets recuperation..... 187
 - Setting the maximum permissible charging current..... 210
 - Starting the charging process (alternating current, mode 2/3)..... 212
 - Starting the charging process (direct current, mode 4)..... 216
 - Stowing the charging cable..... 206
- Post-collision brake**..... 55
- Power closing function**
- Door..... 83
- Power supply**
- Start/stop button..... 171
 - Switching on (start/stop button)..... 171
- Power washer**..... 381
- Pre-entry climate control**
- activating/deactivating for departure time..... 165
 - At time of departure..... 164
 - For departure time..... 165
 - immediate..... 165
 - When vehicle is unlocked..... 163
- Pre-entry climate control via SmartKey**
- Function..... 163
- Pre-entry climate control via the SmartKey**
- Activating/deactivating..... 163
- PRE-SAFE[®], Anticipatory occupant protection**
- Function..... 53
 - PRE-SAFE[®] Sound..... 53
 - Reverting measures..... 53
- PRE-SAFE[®] Impulse Side**
- Function..... 54
 - Inflating..... 55
- PRE-SAFE[®] PLUS**
- Backing up measures..... 53
 - Function..... 53
- Preventative occupant protection system**..... 53
- Profile**..... 329
- Programs**..... 190
- Protection**
- Limited..... 57
- Protection against collision**
- Maneuvering brake function..... 296

- Protection of the environment**
 Driving style..... 25
- Pulling away**
 Hill Start Assist..... 235
 Optimized acceleration..... 175
- Q**
- QR code rescue card**..... 38
- Qualified specialist workshop**..... 35
- R**
- Radar and ultrasonic sensors**..... 228
- Radio**
 MBUX voice commands..... 317
- Radio regulations**
 Regulatory radio identification..... 450
- Rain closing function**
 Sliding sunroof..... 96
- Rain sensor**
 Sliding sunroof..... 96
 Windshield wipers..... 147
- Reading lamp**
 Interior lighting..... 146
- Rear door (child safety lock)**
 Securing..... 74
- Rear fog light**..... 142
- Rear passenger compartment climate control**..... 159
- Rear passenger compartment seat belt**
 Status display..... 49
- Rear view camera**
 360° Camera..... 280
 Function..... 280
 Opening the camera cover..... 287
- Rear window**
 Replacing wiper blade..... 151
- Rear window heater**..... 157
- Rear window wiper**
 Activating/deactivating..... 148
- Rearview mirror**
 Automatic anti-glare mode..... 153
- Rearward-facing child seat**
 Information..... 67
- Recuperation**
 Function..... 186
 Setting..... 187
- Reflective safety vest**..... 388
- Refrigerant**..... 459
- Refueling**
 depressurize the fuel tank (plug-in hybrid with gasoline engine)..... 203
 Fuel..... 201
 Refueling the vehicle..... 201
- Remote Online**
 Charging the starter battery..... 174
 Cooling/heating the vehicle interior..... 173
 Starting the vehicle..... 174
- Replacement key**..... 79
- Reporting safety defects**..... 37
- Reserve**
 Fuel..... 454
- Resetting**
 MBUX reset function..... 336
- Residual heat**..... 160, 161
- Responsibility**
 Driving safety systems..... 228
- Restraint system**
 Basic information..... 44
 Basic instructions for children..... 62

- Deployment situations..... 55
 - Functionality..... 47
 - Information on function..... 55
 - Information on the correct seat position... 45
 - Limited protection..... 57
 - Malfunction..... 47
 - Protection..... 45
 - Self-test..... 47
 - Warning lamp..... 47
 - Reverse gear**
 - DIRECT SELECT lever..... 196
 - Reversing camera**
 - Care..... 383
 - ROAD SURFACE SCAN**..... 274
 - Roadside Assistance (breakdown)**..... 29
 - Roll away protection**..... 234
 - Roller sunblind**
 - Electric..... 97
 - Sliding sunroof..... 93
 - Rollover crash**..... 35
 - Roof load**..... 462
 - Roof load display**
 - Information..... 193
 - Roof luggage rack**
 - Loading..... 133
 - Securing..... 133
 - Route**
 - Alternative route..... 344
 - Calculating..... 344
 - Commuter route..... 344
 - Navigation..... 340
 - Selecting a type..... 344
 - Route guidance with augmented reality**
 - Activating..... 344
 - Activating/deactivating the traffic light view..... 260
 - Displaying road names/house numbers..... 344
 - Switching video on or off..... 344
 - Route-based operating-mode strategy**
 - Function..... 190
 - Route-based speed adaptation**
 - Function..... 244
 - Setting..... 245
 - Run-flat characteristics**..... 391
 - Running boards**
 - Care..... 383
- S**
- Safety system**..... 229
 - Satellite radio**
 - Logging in..... 368
 - Setting music and sport alerts..... 368
 - Seat**
 - Adjusting electrically..... 102
 - Adjusting electrically (rear passenger compartment)..... 105
 - Automatic adjustment..... 111
 - Configuring settings..... 111
 - Correct driver's seat position..... 101
 - Folding back the backrest (rear passenger compartment)..... 125
 - Folding back the backrest on the third row of seats..... 126
 - Folding the backrest (rear passenger compartment) forwards to get in..... 106
 - Folding the backrest on the third row of seats forwards..... 126
 - Lumbar support..... 105
 - Memory function..... 118
 - Panel heating..... 113
 - Rear (seat comfort)..... 105

- Resetting settings (massage programs).. 112
 Settings..... 18
 Side impact air bag..... 60
- Seat (rear passenger compartment)**
 Settings..... 20
- Seat belt**
 Automatic tightening..... 54
 Rear passenger compartment seat
 belt status display..... 49
 Warning lamp..... 48
- Seat belt adjustment**
 Activating/deactivating..... 54
 Function..... 54
- Seat belt warning**..... 48
- Seat belts**
 Activating/deactivating seat belt
 adjustment..... 54
 Care..... 385
 Fastening..... 47
 Notes on wearing correctly..... 46
 Releasing..... 60
 To adjust the height..... 47
- Seat heating**
 Activating/deactivating..... 112
- Seat height**..... 102
- Seat ventilation**..... 113
- Seats, Rear seat, Through-loading feature**
 Folding the backrest forwards (rear
 passenger compartment)..... 122
- Selecting a gear**..... 198
- Selector lever**..... 196
- Self-test**
 Automatic front passenger air bag shu
 toff..... 49
 Restraint system..... 47
- Sensors**
 Cleaning..... 383
- Service**..... 370
- Service center**..... 35
- Service due date**..... 370
- Service interval display**..... 370
- Shifting**
 Automatic transmission..... 198
 Gearshift recommendation..... 199
 Manual..... 198
 Steering wheel paddle shifters..... 198
- Shortening the braking distance**
 Brake Assist System..... 230
- Shunting assistant**..... 298
- Shunting support**..... 296
- Side impact air bag**..... 60
- Side windows**
 Child safety lock (rear passenger
 compartment)..... 75
 Closing with SmartKey..... 91
 Convenience closing..... 91
 Convenience opening..... 91
 Electric roller sunblind..... 97
 Opening with the SmartKey..... 91
 Opening/closing..... 89
 Problem..... 92
- Size designation**
 Tires..... 429
- Skid chains**..... 415
- Sliding sunroof, Panorama roof with
 power tilt/sliding panel**
 Automatic functions..... 96
 Closing with SmartKey..... 91
 Opening with the SmartKey..... 91
 Opening/closing..... 93

- Problem..... 96
 Rain closing function..... 96
- SmartKey**
 Acoustic locking verification signal..... 77
 Activating/deactivating pre-entry climate control..... 163
 Battery..... 78
 Deactivating a function..... 77
 Function..... 76
 Key ring attachment..... 78
 Mechanical key..... 78
 Panic alarm..... 77
 Power consumption..... 77
 Unlocking setting..... 77
- Smartphone Integration, iPhone®**
 Android Auto..... 359
 Apple CarPlay®..... 359
- Snow chains**..... 415
- Socket**
 12 V..... 135
- Socket (115 V), 115 V socket**
 Rear passenger compartment..... 136
- Socket flap**..... 204
- Software update**..... 333
- SOS button**..... 353
- Sound**
 Menu..... 369
 PRE-SAFE® Sound..... 53
 Wheels/tires..... 414
- Sound settings**..... 369
- Spare parts**..... 26
- Spare wheel**..... 443
- Special seat belt retractor**..... 69
- Specialist workshop**..... 35
- speed**
 Save, cruise control..... 241
 Save, DISTRONIC..... 241
- Speed adaptation, Route-based**..... 244
- Speed control**
 Active Distance Assist DISTRONIC..... 239
 Cruise control..... 237
- Speed rating**
 Tires..... 429
- Sport Utility Vehicle**..... 35
- Start-off assist**
 Hill Start Assist..... 235
 Optimized acceleration..... 175
- Start/stop button**
 Parking the vehicle..... 219
 Starting the vehicle..... 172
 Switching on the power supply / vehicle..... 171
- Start/stop function**..... 182
- Starter battery**
 charging, Remote Online..... 174
- Starting**
 Remote Online..... 174
 Start/stop button..... 172
- Starting assistance**..... 402
- Starting the engine**
 Emergency operation mode..... 173
 Remote Online..... 174
 Start/stop button..... 172
- Starting-off aid**
 Drive Away Assist..... 295
 Hill Start Assist..... 235
 Optimized acceleration..... 175































- Status display**
Front passenger air bag..... 49
Rear passenger compartment seat belt.... 49
- Steer Assist**
Active Steering Assist..... 248
STEER CONTROL..... 234
- STEER CONTROL**..... 234
- Steering wheel**
Adjusting electrically..... 115
Driver's air bag..... 60
Manually adjusting..... 114
Steering wheel heater..... 115
- Steering wheel adjustments**..... 115
- Steering wheel heater**
Decoupling from the seat heating..... 116
- Steering wheel paddle shifters**..... 198
- Stop and go**
ECO start/stop function..... 183
- Stopping**
Parking the vehicle..... 219
- Stowage areas**..... 122
- Stowage spaces**
Armrest..... 122
Center console (front)..... 122
Door..... 122
Glove box..... 122
- Substances hazardous to health**..... 29
- Sulfur content**..... 453
- Suspension**
Adjusting the vehicle level (E-ACTIVE BODY CONTROL)..... 276
AIRMATIC..... 266
E-ACTIVE BODY CONTROL..... 272
Individual wheel control (E-ACTIVE BODY CONTROL)..... 276
Rocking free mode (E-ACTIVE BODY CONTROL)..... 275
Setting entering/exiting level (AIR-MATIC)..... 271
Setting the suspension level (AIR-MATIC)..... 268
- Switch-off delay time**
Exterior..... 146
Interior..... 147
- Switching air-recirculation mode on/off**..... 160
- Synchronization function**
Activating/deactivating (control panel)... 160
- System settings**
MBUX reset function..... 336
Overview..... 332
- T**
- Tailgate, Trunk lid**
Closing..... 85
Emergency key..... 89
HANDS-FREE ACCESS..... 87
Limiting the opening angle..... 89
Opening..... 84
Opening dimensions..... 460
- Tank capacity**
Fuel..... 454
Reserve..... 454
- Tank filler cap / flap**..... 201
- Technical data**
High-voltage battery..... 465
Information..... 448
Radio regulations..... 450
Roof load..... 462
Tongue weight..... 466
Towing capacity..... 465



- Telediagnosis**
Diagnostic data..... 371
- Telediagnosics**
Transferred data..... 372
- Telephone, Smartphone**
Bluetooth®..... 352
Charging wirelessly (mobile phone)..... 138
Connecting a mobile phone..... 352
MBUX voice commands..... 317
Menu..... 352
Notes..... 350
Notes on wireless charging (mobile phone)..... 137
Operating modes..... 352
Secure Simple Pairing..... 352
Telephone menu overview..... 351
- Telephony operating modes**
Bluetooth® telephony..... 352
- Television, Digital TV**
MBUX voice commands..... 317
- Temperature**
Setting the vehicle interior temperature..... 157
- Temperature grade**..... 426
- Text messages**..... 318
- Third row of seats, Rear seat, Through-loading feature**
Folding back the backrest on the third row of seats..... 126
Folding the backrest on the third row of seats forwards..... 126
- TIN (Tire Identification Number)**..... 427
- Tire and Loading Information placard**..... 422
- Tire characteristics**..... 429
- Tire information table**..... 422
- Tire labeling**
Characteristics..... 429
DOT, Tire Identification Number (TIN)..... 427
Load index..... 429
Load-bearing capacity..... 429
Maximum tire load..... 428
Maximum tire pressure..... 428
Size designation..... 429
Speed rating..... 429
Temperature grade..... 426
Tire Quality Grading..... 426
Traction grade..... 426
Tread wear grade..... 426
- Tire pressure**
Checking..... 419
Checking manually..... 418
Maximum..... 428
Notes..... 415
Restarting the tire pressure loss warning system..... 421
Tire pressure loss warning system, function..... 421
Tire pressure table..... 417
TIREFIT kit..... 393
- Tire pressure loss warning system**
Function..... 421
Restarting..... 421
- Tire pressure monitor**
Function..... 418
- Tire pressure monitoring system**
Restarting..... 420
- Tire pressure table**..... 417
- Tire Quality Grading**..... 426
- Tire sealant**..... 393
- Tire tread**..... 414
- Tire-change tool**..... 437

- Tire-change tool kit**
 Overview..... 437
- TIREFIT kit**, Tire inflation compressor
 Storage location..... 392, 393
- Tires**
 Breakdown..... 390
 Characteristics..... 429
 Checking..... 414
 Checking the tire pressure manually..... 418
 Definitions..... 431
 DOT, Tire Identification Number (TIN)..... 427
 Installing..... 441
 Labeling..... 426
 Load index..... 429
 Load-bearing capacity..... 429
 Maximum pressure..... 428
 Maximum tire load..... 428
 MOExtended..... 391
 Noise..... 414
 Notes on installing..... 433
 Removing..... 441
 Removing/installing hub cap..... 438
 Replacing..... 433, 438
 Restarting the tire pressure loss warning system..... 421
 Rotating..... 436
 Selecting..... 433
 Size designation..... 429
 Snow chains..... 415
 Speed rating..... 429
 Storing..... 437
 Temperature grade..... 426
 Tire and Loading Information placard..... 422
 Tire pressure loss warning system, function..... 421
 Tire pressure table..... 417
 Tire Quality Grading..... 426
 TIREFIT kit..... 393
 Traction grade..... 426
 Tread wear grade..... 426
 Unusual handling characteristics..... 414
- Toll system**
 Debiting toll fees..... 340
 Windshield..... 155
- Tongue weight**..... 466
- Top Tether**..... 72
- Torque (driver's display)**..... 308
- Touch Control**
 Driver's display..... 306
 MBUX..... 323
- Touch-sensitive controls**..... 27
- Touchscreen**..... 323
- Tow bar system**
 Towing away..... 305
- Tow-away protection**..... 100
- Tow-starting**..... 410
- Towing**
 Towing methods..... 403, 405
- Towing a trailer**
 Active Lane Keeping Assist..... 263
 Notes..... 301
- Towing eye**
 installing/removing..... 389, 409
 Storage location..... 389, 409
- Towing methods**
 Both axles on the ground..... 406
 Overview..... 403, 405
- Traction grade**..... 426
- Traffic information**..... 346
- Traffic Jam Assistant**..... 246

- Traffic light view**
 Activating/deactivating..... 260
 Information..... 260
- Traffic light warning/display**..... 258
- Traffic Sign Assist**
 Function..... 258
 Setting..... 259
- Trailer drawbar, Pulling/towing**..... 305
- Trailer hitch**
 Attaching the ball neck..... 302
 Care..... 383
 Coupling up/uncoupling a trailer..... 303
 General notes..... 465
 Tongue weight..... 466
 Towing capacity..... 465
 Trailer Maneuvering Assist..... 298
- Trailer Maneuvering Assist**
 Function..... 298
 Using..... 299
- Trailer operation**
 Active Blind Spot Assist..... 262
 Attaching the ball neck..... 302
 Coupling up/uncoupling a trailer..... 303
 Setting..... 305
- Trailer stabilization**..... 232
- Transmission position display**..... 196
- Transmission positions**
 DIRECT SELECT lever..... 196
- Transporting**
 Vehicle..... 408
- Tread wear grade**..... 426
- TuneIn Internet Radio**..... 367
- Turn signal indicator**..... 142
- Turn signals**..... 142
- TV**
 MBUX voice commands..... 317
- Two-way radios**
 Frequencies..... 449
 Installation..... 448
 Transmission output..... 449
- U**
- Unfastening**..... 60
- Unlocking setting**..... 77
- Updates**..... 333
- USB port**
 Rear passenger compartment..... 137
 Stowage compartments (front)..... 122
- User profiles**
 Adding a user..... 330
 Note..... 329
 Selecting options..... 330
- V**
- Vehicle, Switching on the ignition**
 48 V on-board electrical system..... 29
 Activating, Remote Online..... 174
 Activating/deactivating standby mode... 228
 Correct use..... 35
 Data storage..... 38
 Diagnostics connection..... 34
 Emergency key..... 83
 Equipment..... 27
 High-voltage on-board electrical system... 29
 KEYLESS-GO..... 81
 Limited Warranty..... 38
 lock automatically (MMS)..... 82
 Locking/unlocking (from inside)..... 80
 Locking/unlocking emergency key..... 83
 Lowering..... 442

- Maintenance..... 29
- Medical aids..... 36
- Parking..... 219
- Parking for an extended period..... 227
- Problem notification..... 37
- Pulling..... 305
- QR code rescue card..... 38
- Raising..... 439
- Set collision detection..... 226
- Standby mode function..... 227
- Starting (start/stop button)..... 172
- starting, emergency operation mode..... 173
- Stopping..... 219
- Switching off (start/stop button)..... 219
- Switching on (start/stop button)..... 171
- Towing away..... 403, 405
- Transporting..... 408
- ventilating / convenience opening..... 91
- Voice commands for MBUX voice assistant..... 318
- Vehicle cameras**..... 228
- Vehicle data**
- Angle of approach/departure..... 462
- Display, MBUX..... 195
- Displaying, DYNAMIC SELECT..... 195
- Fording depth..... 462
- Maximum gradient-climbing capability.... 462
- Roof load..... 462
- Turning circle..... 460
- Vehicle height..... 460
- Vehicle length..... 460
- Vehicle width..... 460
- Wheelbase..... 460
- Vehicle dimensions**..... 460
- Vehicle emergency start**..... 410
- Vehicle equipment**..... 27
- Vehicle identification number**..... 450
- Vehicle identification plate**
- Model type..... 450
- Paint code..... 450
- VIN..... 450
- Vehicle interior**
- Cooling/heating (Remote Online)..... 173
- Vehicle key**..... 76
- Vehicle level**
- Lowering/raising the rear end of the vehicle (AIRMATIC)..... 271
- Setting (AIRMATIC)..... 268
- Setting (E-ACTIVE BODY CONTROL)..... 276
- Setting entering/exiting level (AIR-MATIC)..... 271
- Setting individual wheel control..... 279
- Vehicle operation outside the USA or Canada**..... 28
- Vehicle sensors**..... 228
- Vehicle socket**
- Care..... 383
- Emergency release of the socket flap.... 218
- Indicator lamps..... 211
- Vehicle start**
- Emergency operation mode..... 173
- Remote Online..... 174
- Start/stop button..... 172
- Vehicle tool kit**
- TIREFIT kit..... 392, 393
- Towing eye..... 389, 409
- Vehicle with a high center of gravity**..... 35
- Ventilating**..... 91
- Ventilation**..... 166
- Vents**
- Air vents..... 166

- VIN**
 Engine compartment..... 450
 Identification plate..... 450
 Seat..... 450
- Vision**
 Defrosting windows..... 160
- Voice assistant**
 Voice prompting..... 313, 325
- Voice Control System**
 Operating safety..... 313
- W**
- Warning system**..... 98
- Warning triangle**..... 389, 390
- Warning/indicator lamp**
-  ABS warning lamp..... 548
 -  Active Brake Assist warning lamp..... 551
 -  ATTENTION ASSIST warning lamp..... 550
 -  Brakes warning lamp (Canada only)..... 547
 -  Brakes warning lamp (USA only)... 547
 -  Brakes warning lamp (yellow) (Canada only)..... 546
 -  Check Engine warning lamp..... 543
 -  Coolant warning lamp (red)..... 542
 -  Coolant warning lamp (yellow)..... 543
 -  Distance warning lamp..... 550
 -  Electric parking brake indicator lamp (red) (Canada only)..... 545
 -  Electric parking brake indicator lamp (red) (USA only)..... 545
 -  Electric parking brake indicator lamp (yellow)..... 545
 -  Electrical malfunction warning lamp..... 540, 544
 -  Engine operating temperature warning lamp..... 541
 -  ESP® OFF warning lamp..... 549
 -  ESP® warning lamp flashes..... 548
 -  ESP® warning lamp lights up..... 549
 -  Fuel reserve warning lamp flashes..... 544
 -  Fuel reserve warning lamp lights up..... 544
 -  Mercedes-Benz emergency call system warning lamp..... 552
 -  Power steering warning lamp (red)..... 541
 -  Power steering warning lamp (yellow)..... 540
 -  RBS warning lamp (USA only)..... 546
 -  Reduced warning lamp power..... 539
 -  Restraint system warning lamp..... 538
 -  Seat belt warning lamp flashes..... 539
 -  Seat belt warning lamp lights up... 539
 -  Suspension warning lamp (red).... 551
 -  Suspension warning lamp (yellow)..... 551
 -  System malfunction warning lamp..... 540

-  Tire pressure monitoring system warning lamp flashes..... 552
 -  Tire pressure monitoring system warning lamp lights up..... 553
- Warning/indicator lamps**
 - Driver's display..... 536
 - PASSENGER AIR BAG..... 49
- Washer fluid**
 - Topping up..... 377
 - Windshield washer fluid..... 458
- Washing by hand**..... 381
- Water tank**..... 378
- Wear**
 - Limited protection..... 57
- Weather information**..... 346
- Web browser**..... 358
- Wedge**..... 437
- Weight information**..... 450
- Wheel change**
 - Installing a new wheel..... 441
 - Lowering the vehicle..... 442
 - Removing a wheel..... 441
 - Removing/installing hub caps..... 438
- Wheel rotation**..... 436
- Wheels**
 - Breakdown..... 390
 - Care..... 383
 - Checking..... 414
 - Checking the tire pressure manually..... 418
 - Definitions..... 431
 - DOT, Tire Identification Number (TIN)..... 427
 - Installing..... 441
 - Load index..... 429
 - Load-bearing capacity..... 429
 - Maximum tire load..... 428
 - Maximum tire pressure..... 428
 - MOExtended..... 391
 - Noise..... 414
 - Notes on installing..... 433
 - Removing..... 441
 - Removing/installing hub cap..... 438
 - Replacing..... 433, 438
 - Rotating..... 436
 - Selecting..... 433
 - Size designation..... 429
 - Snow chains..... 415
 - Speed rating..... 429
- Storing..... 437
- Temperature grade..... 426
- Tire and Loading Information placard..... 422
- Tire characteristics..... 429
- Tire labeling..... 426
- Tire pressure..... 415
- Tire pressure monitor..... 418
- Tire Quality Grading..... 426
- TIREFIT kit..... 393
- Traction grade..... 426
- Tread wear grade..... 426
- Unusual handling characteristics..... 414
- Wi-Fi**
 - Setting up a hotspot..... 334
- Window curtain air bag**..... 60
- Windows**
 - Care..... 383
 - Opening/closing..... 89
 - Removing mist..... 160
- Windshield**
 - Defrosting..... 157
 - Infrared reflective..... 156
 - Radio waves..... 155
 - Replacing the wiper blades..... 148

Replacing the wiper blades with MAGIC VISION CONTROL.....	150	Workshop	35
Toll system.....	155		
Windshield washer fluid	458		
Windshield washer system	377		
Windshield wiper			
Replacing the wiper blades with MAGIC VISION CONTROL.....	150		
Windshield wipers			
Activating/deactivating.....	147		
Replacing the windshield wiper blades....	148		
Replacing the wiper blades.....	148		
Winter operation			
Snow chains.....	415		
Wiper blades			
Care.....	383		
Replacing (windshield).....	148		
Replacing with MAGIC VISION CON- TROL.....	150		
Wipers	147		
Wireless charging			
Mobile phone.....	138		
Overview.....	137		





